

NOTICE

- * Please make sure that you have all parts indicated and they are in good condition before you begin assembly of this item. Refer to part list and hardware list below for guidance.
- * This item should be assembled on a soft surface to prevent scratching the finish during assembly.
- * This item may require periodic tightening.
- * If you are having difficulty, our friendly Customer Care team is always here to help.







PREPARATION

- * Before beginning assembly of product, make sure all parts are present. Compare parts with part contents list and hardware contents list.
- * If any part is missing or damaged, do not attempt to assemble the product.
- * Estimated Assembly Time: 10 minutes.
- * Tools Required for Assembly (included): Allen Key

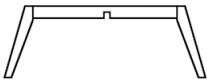
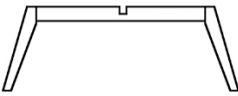
CARE AND MAINTENANCE

Spot clean using a mild water-free solvent. Only a professional cleaner should undertake a complete overall cleaning.
The use of steam or water-based cleaners may cause excessive shrinking or staining.

Part List and Hardware List

PIECE	DESCRIPTION	PICTURE	QUANTITY
A	Top Plate		1X
B	Leg1		1X
C	Leg2		1X
HW1	Split Lock Washer 6mm		8X
HW2	Flat Washer 6mm		8X
HW3	Socket Bolts 6x1x35mm		8X
HW4	Allen Key		1X
HW5	Felt Pad		4X

Product Dimensions: 15"H x43.5"W x18"D

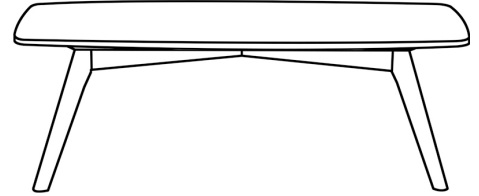

Weight Capacity - 220 LBS

Warning: Do not stand on Table

Warning: Do not over torque bolts.

PREPARATION

- * Before beginning assembly of product, make sure all parts are present. Compare parts with part contents list and hardware contents list.
- * If any part is missing or damaged, do not attempt to assemble the product.
- * Estimated Assembly Time: 10 minutes.
- * Tools Required for Assembly (included): Allen Key
- * If you are having difficulty, our friendly Customer Care team is always here to help.

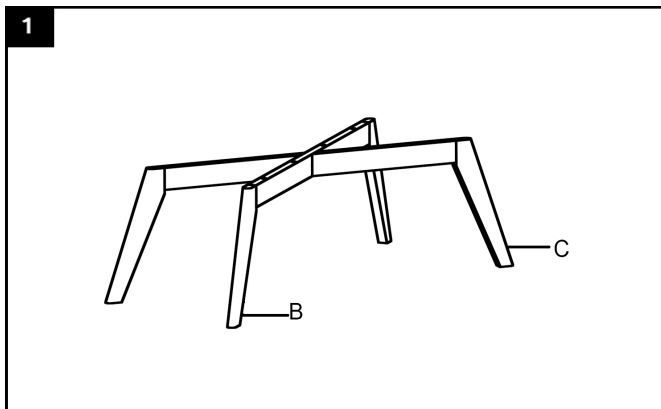

Step1: Cross Leg1(B) and Leg2(C)

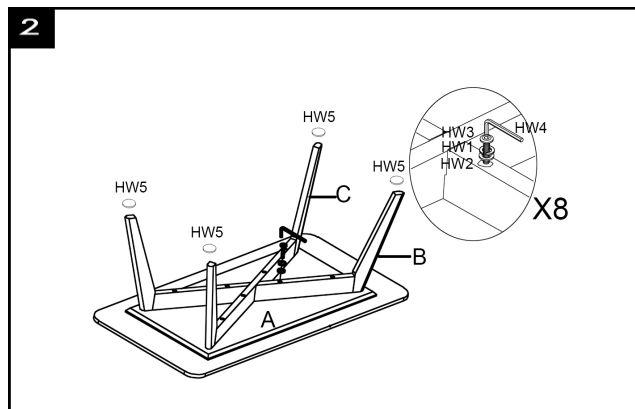

Step2: Attach the cross legs to top plate(A), using 8 split lock washer(HW1) and 8 flat washer(HW2) and 8 socket bolts(HW3). Screw on all bolts and tighten in the end by using allen key(HW4). Put on the felt pad(HW5).