

ASSEMBLY INSTRUCTION

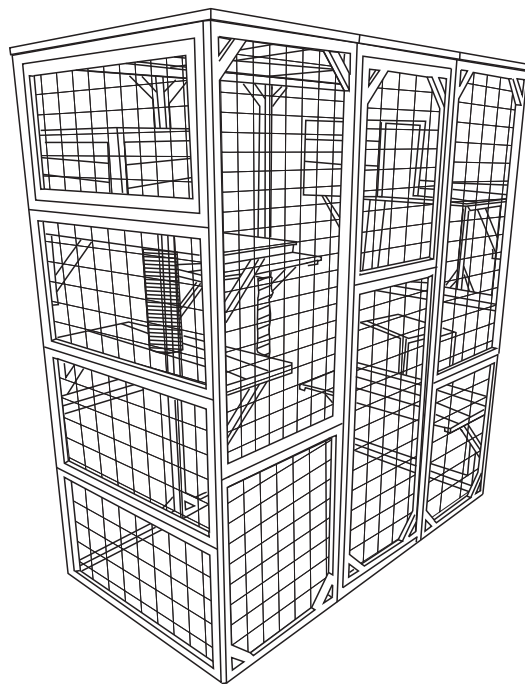











The cat cage

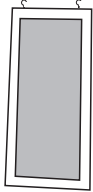
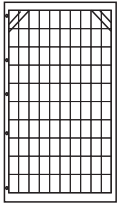
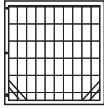
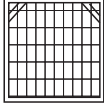
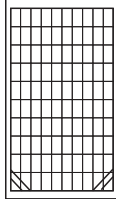
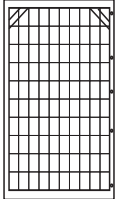
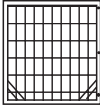
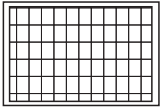
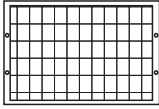
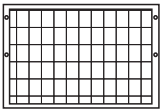
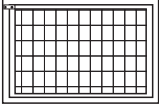
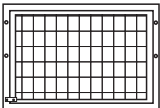

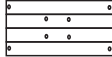
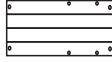
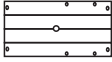
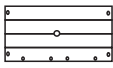
Notice:

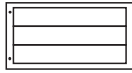
1. 50% Tighten before fixing all screws, Allen wrench is recommended instead of an electric drill.
2. Place the item on a flat ground to adjust and make sure it remains stable.
3. Tighten up all screws with tools gradually.
4. If the screws are not aligned with holes during assembly please loosen all the other screws to 50% and continue the assembly process,
5. If the item is not stable, please loosen all the screws, adjust it on a flat ground and tighten up all screws again.
6. Note :If one or some screws are fully tightened during assembly, chances are the others will not be aligned with holes. In addition, all the holes are designed to be relatively larger to provide more space for the adjustment of the screws.

Parts List

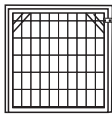
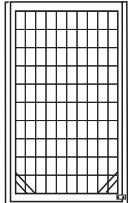
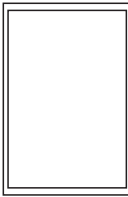
<p>A1</p>  <p>4*50mm</p> <p>26PCS</p>	<p>A2</p>  <p>4*40mm</p> <p>52PCS</p>	<p>A3</p>  <p>4*25mm</p> <p>40PCS</p>	<p>A4</p>  <p>4*20mm</p> <p>20PCS</p>	<p>A5</p>  <p>10*40mm</p> <p>2PCS</p>	<p>A</p>  <p>1PC</p>
<p>B</p>  <p>2PCS</p>	<p>C</p>  <p>2PCS</p>	<p>D</p>  <p>1PC</p>	<p>E</p>  <p>1PC</p>	<p>F</p>  <p>2PCS</p>	
<p>G</p>  <p>2PCS</p>	<p>H</p>  <p>3PCS</p>	<p>I</p>  <p>2PCS</p>	<p>J</p>  <p>1PC</p>	<p>K</p>  <p>1PC</p>	
<p>L</p>  <p>1PC</p>	<p>M</p>  <p>10PCS</p>	<p>N</p>  <p>1PC</p>	<p>O</p>  <p>2PCS</p>	<p>P</p>  <p>1PC</p>	
<p>Q</p>  <p>1PC</p>	<p>R</p>  <p>1PC</p>	<p>S</p>  <p>4PCS</p>	<p>T</p>  <p>4PCS</p>	<p>U</p>  <p>2PCS</p>	
<p>V</p>  <p>2PCS</p>	<p>W</p>  <p>1PC</p>	<p>X</p>  <p>1PC</p>	<p>Y</p>  <p>1PC</p>	<p>Z</p>  <p>3PCS</p>	

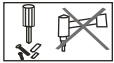

Step 1

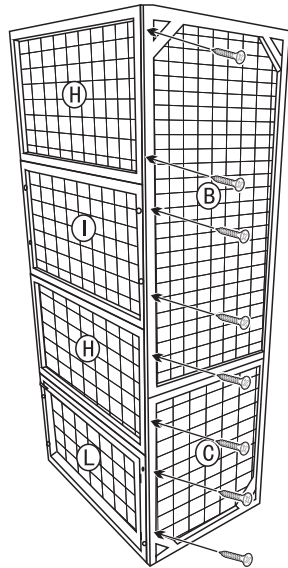

A2 8PCS

Step 2

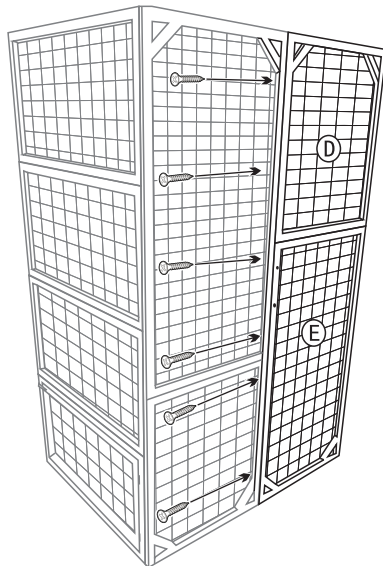

A1 6PCS

Step 3

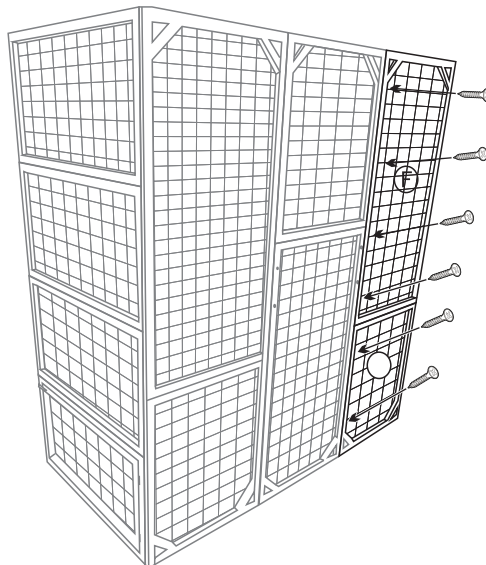

A1 6PCS

Step 4

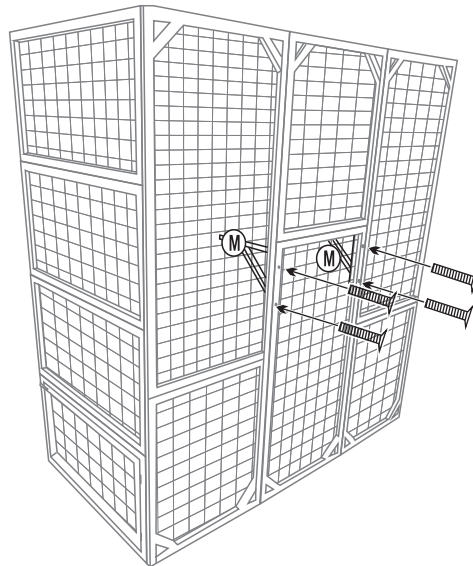

A4 4PCS

Step 5

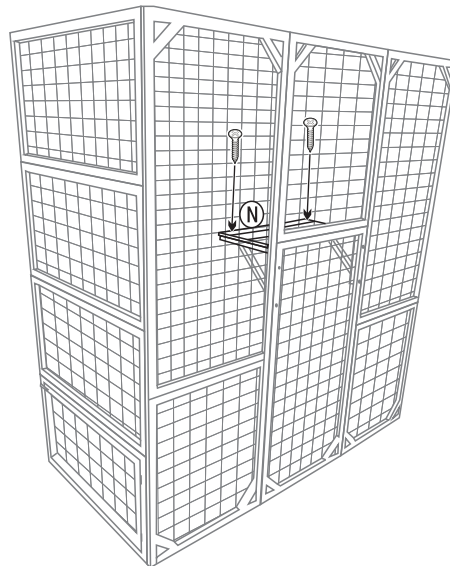

A3 4PCS

Step 6

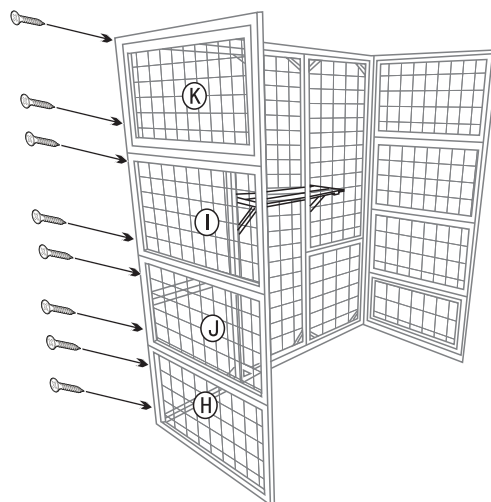

A2 8PCS

Step 7

A2 8PCS

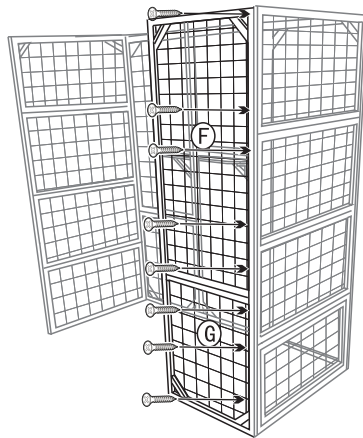

Step 8

A2 8PCS

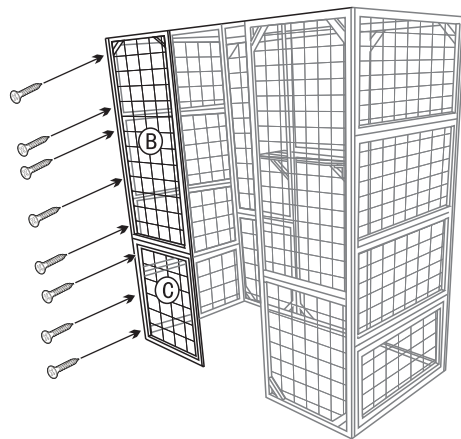

Step 9

A4 16PCS

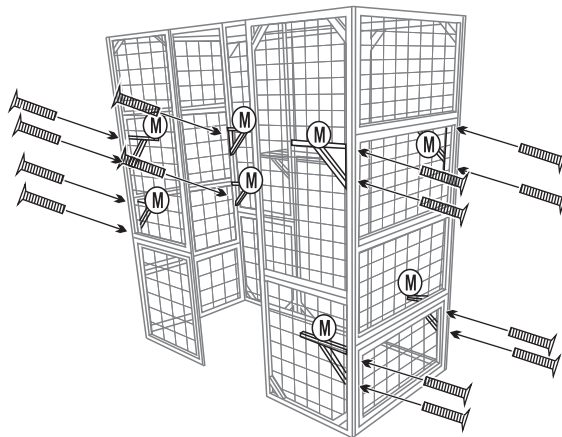

Step 10

A3 16PCS

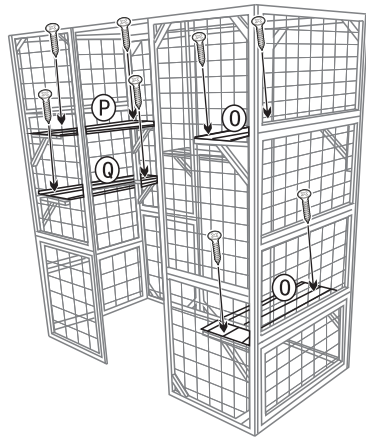

Step 11

A5 2PCS

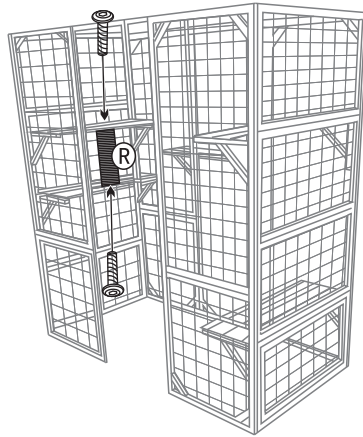

Step 12

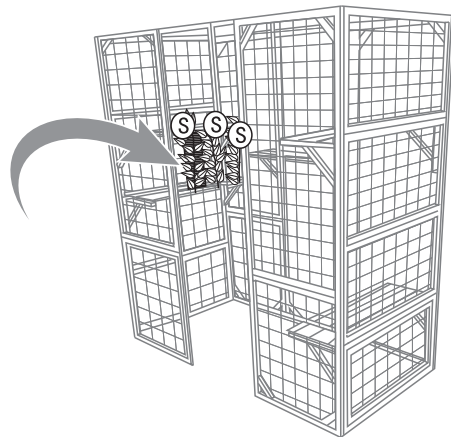

Step 13

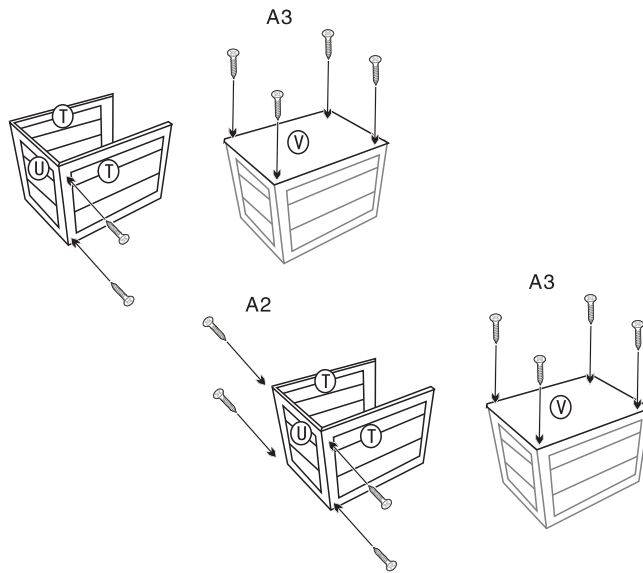

A2 8PCS
A3 8PCS

Step 14

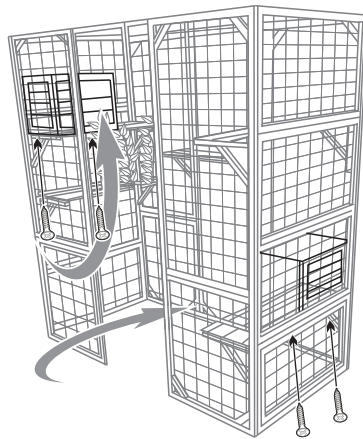

A3 8PCS

Step 15

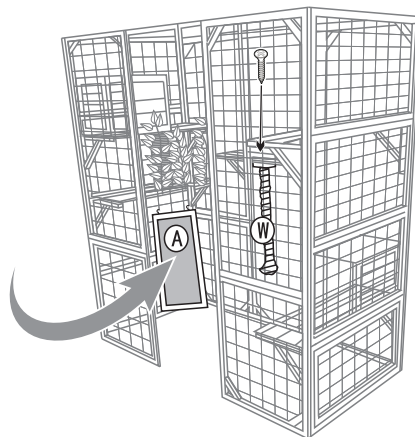

A3 4PCS

Step 16

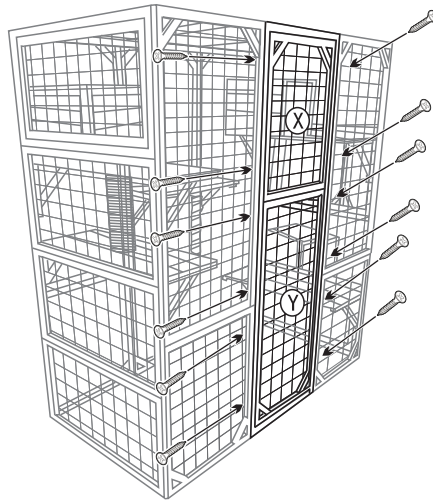

A1 12PCS

Step 17

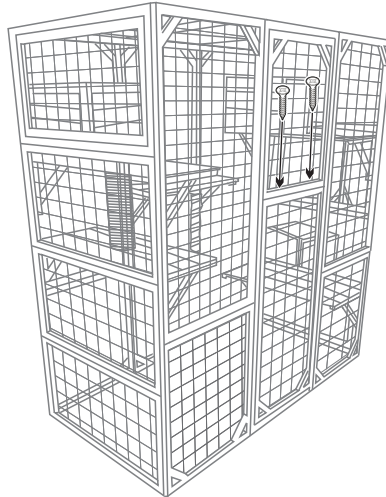

A1 4PCS

Step 18

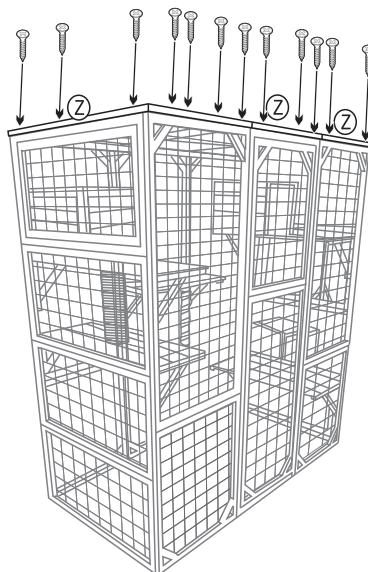

A2 12PCS