

**AQUA
GALLERY**

User's Manual



INSTALLATION INSTRUCTIONS

Installation Manual



IAPMO RESEARCH AND TESTING, INC.
500 East Philadelphia Street, Ontario, California 91761-2814 • USA • 909-473-4100 • 909-473-4244 • www.iapmo.com

ANSI **IAPMO** **UPC**

CERTIFICATE OF LISTING

IAPMO Research and Testing, Inc. is a professional testing organization that provides independent testing services to assist manufacturers in demonstrating compliance with applicable regulatory requirements. This certificate is issued to the manufacturer of the product described herein, and is not intended to be construed as an endorsement, approval or warranty by IAPMO Research and Testing, Inc. for the product or the manufacturer.

This certificate is not an endorsement of product quality. It is only a listing of product. Visit the IAPMO R&T website for more information.

Effective Date: December 2019 Rev: 1/24/2020 Valid Until: December 2024
Product: **Flushing Fixture Components** File No. 10263

Issued To: **Apex Shilling Co., Ltd.**
17000 15th Street
Lanham, MD 21053
Phone: 410-321-1000
Fax: 410-321-1001

Identification: Products shall be marked with manufacturer's name or trademark, a permanent "Do not remove" identification mark, and the model number. The marking shall also bear the "UPC" certification mark. Markings shall be by means of either a permanent mark on the product, a label on the product or a tag attached to the product.

Characteristics: Flushing fixture components manufactured to various codes, heights and sizes, and listing for use in cold water applications that consist of an elongated, oval, rectangular, or square shape, and are used to flush a toilet. Components are to be installed for use in accordance with the listing. The listing is in accordance with the manufacturer's literature, and the latest edition of the Uniform Plumbing Code and National Plumbing Code of Canada.

Reference: Listed on this certificate have been tested by an IAPMO R&T recognized laboratory. This recognition has been granted based upon the following information:

Tom Shilling *Ron Ching*

This listing is based on the information provided by the manufacturer. IAPMO Research and Testing, Inc. is not responsible for the accuracy of the information provided. The manufacturer is responsible for the accuracy of the information provided. IAPMO Research and Testing, Inc. is not responsible for the accuracy of the information provided. The manufacturer is responsible for the accuracy of the information provided.

IAPMO RESEARCH AND TESTING, INC.
500 East Philadelphia Street, Ontario, California 91761-2814 • USA • 909-473-4100 • 909-473-4244 • www.iapmo.com

ANSI **IAPMO** **UPC**

CERTIFICATE OF LISTING

IAPMO Research and Testing, Inc. is a professional testing organization that provides independent testing services to assist manufacturers in demonstrating compliance with applicable regulatory requirements. This certificate is issued to the manufacturer of the product described herein, and is not intended to be construed as an endorsement, approval or warranty by IAPMO Research and Testing, Inc. for the product or the manufacturer.

This certificate is not an endorsement of product quality. It is only a listing of product. Visit the IAPMO R&T website for more information.

Effective Date: December 2019 Valid Until: December 2024
Product: **Flushing Fixture Fittings** File No. 10263

Issued To: **Apex Shilling Co., Ltd.**
17000 15th Street
Lanham, MD 21053
Phone: 410-321-1000
Fax: 410-321-1001

Identification: Flushing fixture fittings including sink trap washers shall be marked with the manufacturer's registered name, trademark, or other mark or, in the case of private labeling, the name, trademark or other mark of the customer for whom the fitting was manufactured. The marking shall be accompanied by one of a permanent mark or by placing a permanent label on the fitting. Markings on plastic fittings shall be visible after installation.

Characteristics: Elongated, oval, rectangular, and automatic compressing fixture washers and shower valves shall have identifiable temperature markings in which the marking are indicated by words "Hot", "Warm", "Cool", etc., by numbers, or graphically.

Reference: Listed on this certificate have been tested by an IAPMO R&T recognized laboratory. This recognition has been granted based upon the following information:

Tom Shilling *Ron Ching*

This listing is based on the information provided by the manufacturer. IAPMO Research and Testing, Inc. is not responsible for the accuracy of the information provided. The manufacturer is responsible for the accuracy of the information provided. IAPMO Research and Testing, Inc. is not responsible for the accuracy of the information provided. The manufacturer is responsible for the accuracy of the information provided.

IAPMO RESEARCH AND TESTING, INC.
500 East Philadelphia Street, Ontario, California 91761-2814 • USA • 909-473-4100 • 909-473-4244 • www.iapmo.com

ANSI **IAPMO** **UPC**

CERTIFICATE OF LISTING

IAPMO Research and Testing, Inc. is a professional testing organization that provides independent testing services to assist manufacturers in demonstrating compliance with applicable regulatory requirements. This certificate is issued to the manufacturer of the product described herein, and is not intended to be construed as an endorsement, approval or warranty by IAPMO Research and Testing, Inc. for the product or the manufacturer.

This certificate is not an endorsement of product quality. It is only a listing of product. Visit the IAPMO R&T website for more information.

Effective Date: March 2019 Valid Until: March 2024
Product: **Flushing Fixture Fittings - Components** File No. 10263

Issued To: **Apex Shilling Co., Ltd.**
17000 15th Street
Lanham, MD 21053
Phone: 410-321-1000
Fax: 410-321-1001

Identification: Each fitting component shall be marked with the manufacturer's name or trademark, a permanent "Do not remove" identification mark, and the model number. The marking shall also bear the "UPC" certification mark. Markings shall be by means of either a permanent mark on the product, a label on the product or a tag attached to the product.

Characteristics: Flushing fixture fittings components to be installed in accordance with the manufacturer's literature and the requirements of the latest edition of the Uniform Plumbing Code.

Reference: Listed on this certificate have been tested by an IAPMO R&T recognized laboratory. This recognition has been granted based upon the following information:

Tom Shilling *Ron Ching*





This listing is based on the information provided by the manufacturer. IAPMO Research and Testing, Inc. is not responsible for the accuracy of the information provided. The manufacturer is responsible for the accuracy of the information provided. IAPMO Research and Testing, Inc. is not responsible for the accuracy of the information provided. The manufacturer is responsible for the accuracy of the information provided.

BEFORE INSTALLATION

► Installation Environment

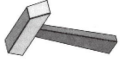
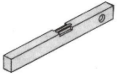
1. Before installation, confirm whether the inlet pipe and angle valve are correct. Make sure that the installation is completed, and the water has been flushed to ensure that there are no impurities in the water inlet pipe;
2. Water inlet pressure requirements: $5\text{bar} \geq \text{inlet pressure} \geq 0.5\text{bar}$, it is recommended to install a pressure reducing valve if it is greater than 0.05MPa ;
3. When installing and using the faucet, please use normal torque to prevent the handle from breaking.
4. If the customer goes out for a long time or does not use the faucet for a long time, please close the faucet valve and turn on the faucet switch to release the pressure and water in the faucet.

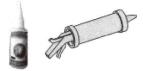
► Installation Aids

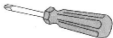
 Hammer	 Spirit level	 Adjustable wrench
 Glue (do not use glue containing acetic acid)	 Impact drill	 Screwdriver

► Dimension Diagram

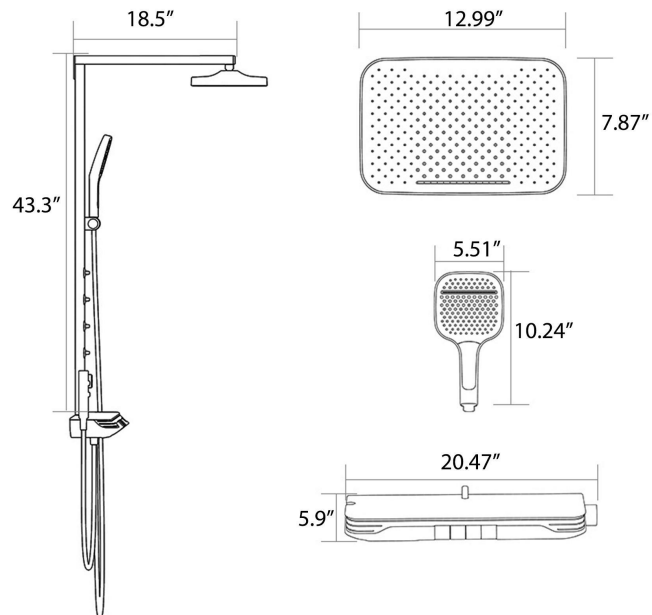

INSTALLATION STEPS

This product has been inspected and debugged by the factory to the best condition. Please do not disassemble and assemble it yourself.

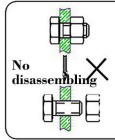

Before installing the faucet, please be sure to remove sundries and sludge from the water pipe to prevent sundries from blocking the faucet.

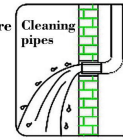

Before installation, please confirm:
 a. If the water inlet fitting is higher than the wall surface by more than 2mm, it cannot be installed.
 If the water inlet fitting is lower than the wall surface by 15mm, you need to purchase an extension fitting yourself.

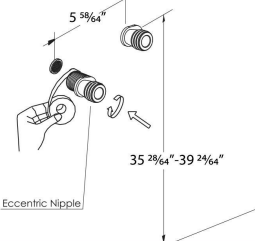

Eccentric Nipple

1

Apply pipe sealant to the threads of the eccentric nipples, then connect them to the inlet pipes. (The distance between the two water supply lines is 5.9 inches (150mm), and the distance from the floor surface to the water outlet is approximately 35.4-39.4 inches (900-1000mm).)

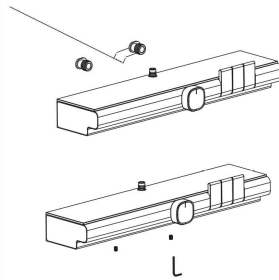

2

The fitting protrudes from the wall by 1.06 inches - 1.18 inches (27mm - 30mm). Insert the body into the fitting, push the body against the wall, and tighten the two screws below the body.

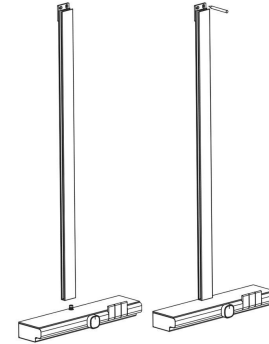

3

Insert the long shower pipe into the body fitting, mark the two fixing hole positions on the long shower pipe with a pen, and make sure the pipe is vertical.

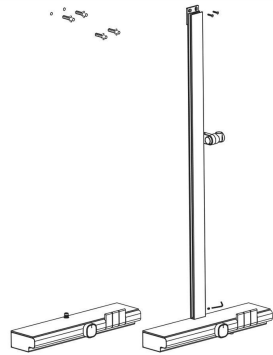

4

After drilling holes at the marked positions, insert the expansion bolts, and then insert the vertical pipe into the adjustable shower holder. Fix the long shower pipe with two self-tapping screws, and tighten the screws at the bottom of the vertical shower pipe.



5

Insert the horizontal pipe connector into the straight pipe, and lock the two pipes with two screws.

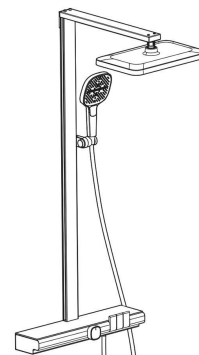

6

Install the hand shower hose, hand shower, and the overhead shower.

INSTALLATION STEPS

● User Guide

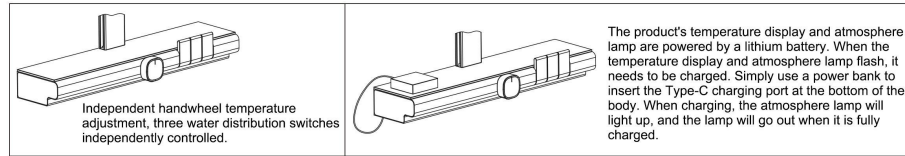

● Mixer Care and Maintenance Tips

a. Regular Cleaning:

For daily or regular cleaning, simply wash the mixer with clean water and wipe it dry with a soft cotton cloth.

Avoid using cleaning powder, polishing powder, abrasive detergents, or nylon brushes, as these can scratch and damage the surface.

Do not use acidic cleaning agents. If the mixer comes into contact with any harmful acids, rinse it immediately with clean water.

b. Deep Cleaning:

For deeper cleaning:

First, remove as much dirt and grime as possible with clean water and a soft cloth. Then, use one of the following cleaning agents:

- Mild liquid cleanser
- Colorless glass cleaner with no abrasives (ensure it completely dissolves according to instructions)
- Non-abrasive polish liquid

After cleaning, thoroughly rinse off all cleaning agent with clean water and wipe dry with a soft cotton cloth.



Please feel free to contact us if you have any questions. We will help to solve the issue together with you.



**AQUA
GALLERY**