

Review all assembly and care information before using this product. Save this manual for future reference.

Select a smooth, level surface to place the fountain.

Assemble components on a soft, clean surface to avoid scratching or damaging the finish.









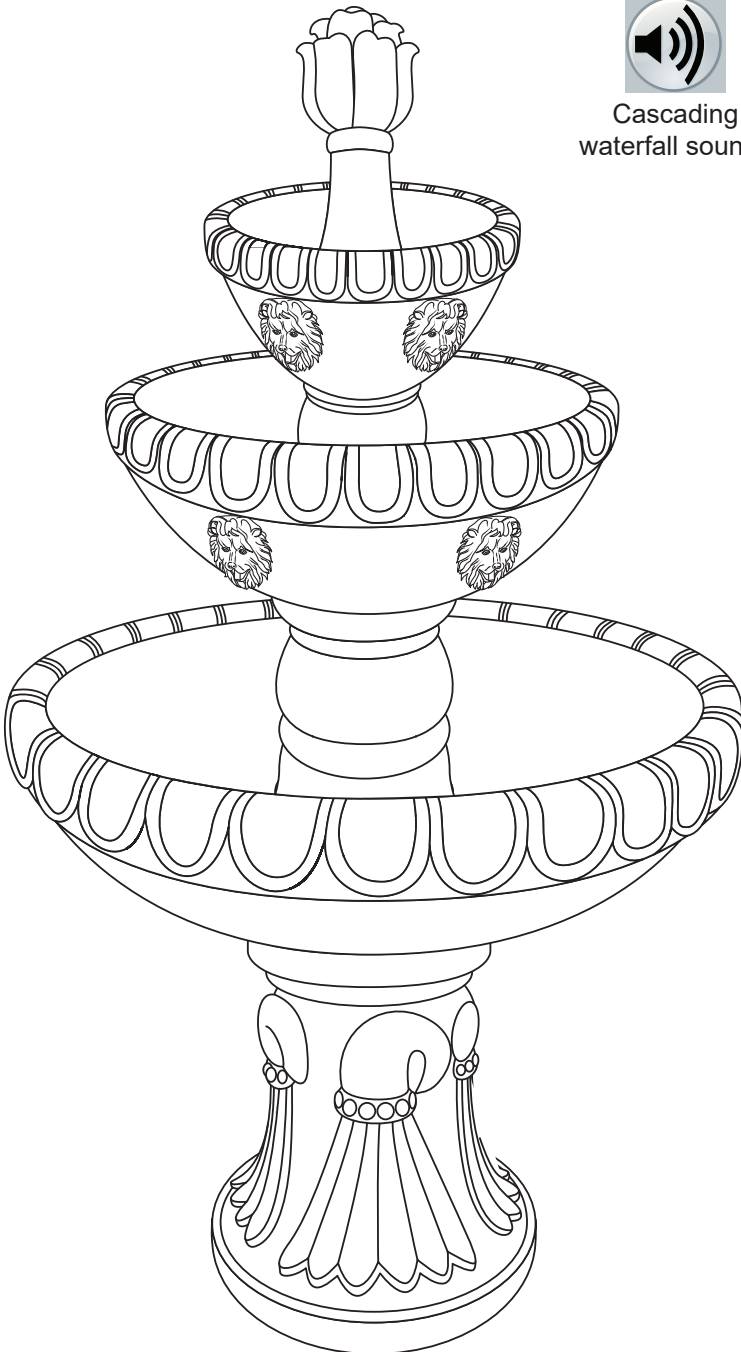

Cascading waterfall sounds

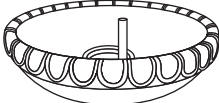

Inspect packaging to ensure all parts are accounted for before disposing of packing materials.
 Save the packing slip.



PARTS		QTY.
	Topper	1
	Top Tier	1
	Middle Bowl	1
	Column	1
	Pump Access Panel	
	Bottom Bowl	1
	Pedestal	1
	Stopper Plug	1
	Electric Submersible Pump	1



IMPORTANT NOTES:

- The water tubing is built into the fountain topper. Take care when handling the water tube; detaching the water tube from the fountain will damage the unit and void the warranty.
- Familiarize yourself with the flow control valve on the pump, maximum (+) and minimum (-). This may need to be adjusted to achieve optimal water flow.
- Rattling noise inside the fountain? Due to the casting process, there may be loose pieces of casting material inside the fountain.

ASSEMBLY

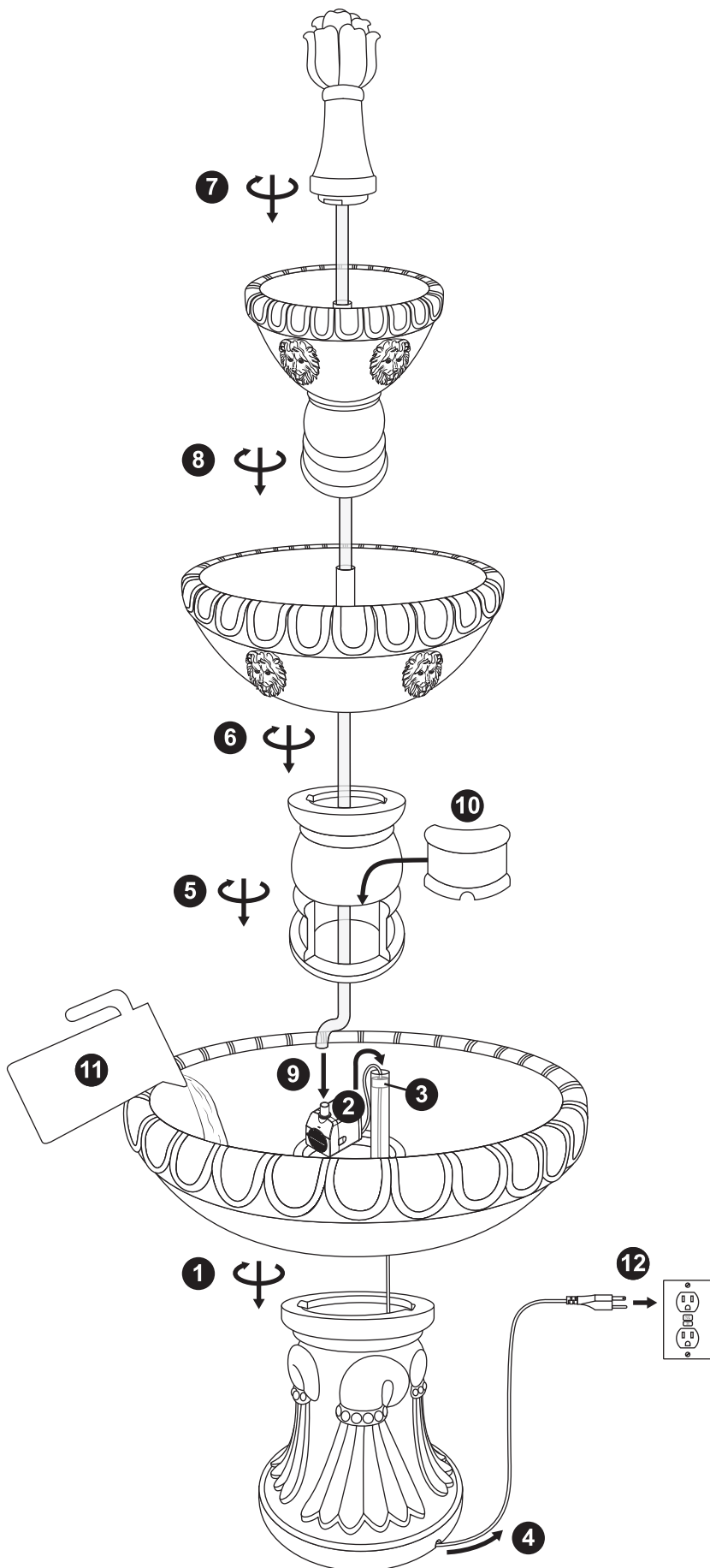

1. Place the bottom bowl onto the pedestal, twist to lock in place.
2. Run the pump power cord down the built-in tube in the bottom bowl and place the electric submersible pump in the center of the bottom bowl.
3. Ensuring the power cord has enough slack for the pump to remain upright, put the stopper plug on the power cord and press the plug into the pipe.
4. Run the power cord out through the groove in the bottom of the pedestal.
5. Align the column with the bottom bowl, twist to lock in place.
6. Align the middle bowl on the column, twist to lock in place.
7. Run the water tube that is built into the topper through the top tier, twist to lock the topper onto the top tier.
8. Run the water tube through the middle bowl, align the assembled top with the middle bowl, twist to lock in place.
9. Firmly connect the water tube to the pump.
10. Install the pump access panel.
11. Fill each tier with enough water to keep the pump fully submerged during operation, approximately 9 gallons (34.1L).
12. Plug the power cord into a properly grounded GFCI outlet.

NOTE: When first plugged in, there may be air trapped in the pump. It may take several minutes for trapped air to escape, allowing water to flow.

Care & Maintenance

- Some splashing may occur; adjust the flow rate on the pump if the water rate is too low or too high.
- Some climates and weather conditions increase water evaporation, requiring water to be added more frequently. Frequently check water levels during times of high temperatures, wind, and long-term exposure to direct sunlight to ensure the pump remains underwater. Never allow the pump to run dry as it will burn out the motor.
- Only use water in this fountain. Distilled water will help prevent mineral buildup but is not required. Tap water is okay to use, but avoid heavily chlorinated water as it may damage the fountain finish and the pump.
- Over time, the finish may gradually mellow in color due to sun exposure; this is part of the natural aging process and is not cause for return.
- Periodically change the water to help keep the fountain and pump clean. Remove scale and buildup regularly.
 - DO NOT use harmful additives such as bleach, chlorine, etc.
 - DO NOT use anything that is abrasive to scrub the fountain.
 - DO NOT use a pressure washer to clean the fountain.
- Always unplug the power supply before cleaning and maintaining the fountain and the circulating pump. Take care when handling the pump; only pick it up by the body of the pump, never the power cord.
- During freezing weather, drain the fountain, disconnect the pump and store indoors; allowing ice to form may damage the fountain in such ways as, but not limited to, fountain cracking and permanent pump damage.

WARNING: THE ONE-YEAR WARRANTY DOES NOT COVER DAMAGES OR DEFECTS CAUSED BY THE APPLICATION OF CHEMICAL TREATMENTS, PROTECTIVE COATINGS, TOUCH-UP PAINT, OR CLEANING PRODUCTS.

Troubleshooting

- If water is not flowing within several moments of the fountain being plugged in, ensure that the pump is fully submerged underwater. Add water to the reservoir if necessary. The pump may have air bubbles trapped inside, which can prevent water from circulating properly. Unplug the power supply for a few moments and plug it back in.
- Check the flow control on the body of the pump, it may need to be adjusted to achieve the desired water flow rate.
- Inspect the pump and tubing for obstructions.
- Pump noise can be caused by trapped air, low water level, or the pump being too close to the walls of the fountain. While the pump is fully submerged, try gently tapping the pump with your finger to help release the trapped air. Also, check if adding water or moving the pump helps to reduce noise.
- Check to make sure the power outlet is working; consult a certified electrician if in doubt about electrical connections.



IMPORTANT SAFETY INFORMATION



- Fountains may splash or leak; always protect surfaces that can be damaged by water. Do not use fountain in areas that can be damaged if water splashes or leaks.
- Prevent water loss or damage to electrical sockets by ensuring the power cord has a drip loop; a diagram of a drip loop is shown on the right.
- Keep fountain out of reach of children and pets.
- Make sure the power cord is away from traffic areas.
- Keep power cord away from all heat sources. Do not use electrical cords in areas with high temperatures.
- Check the water level frequently to ensure the pump remains fully submerged; never allow the pump to run dry as it will burn out the motor.
- Always unplug the power supply before cleaning and maintaining the fountain and the pump.
- Always empty and store the fountain and pump indoors during freezing weather.

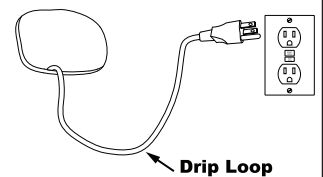

Drawing is for visual reference only, power cord access and adapter vary by fountain.

Any modification to the product or failure to follow recommended care will void the product warranty.

If you experience issues with assembly or the product was damaged during shipping, please contact our customer service team through one of the methods mentioned at the top of page 1. Please have the item number and order information ready to expedite response time.

WARNING:

Manufacturer and seller expressly disclaim any and all liability from personal injury, property damage or loss, whether direct or indirect, or incidental, resulting from the incorrect attachment, improper use, inadequate maintenance, or neglect of this product.