

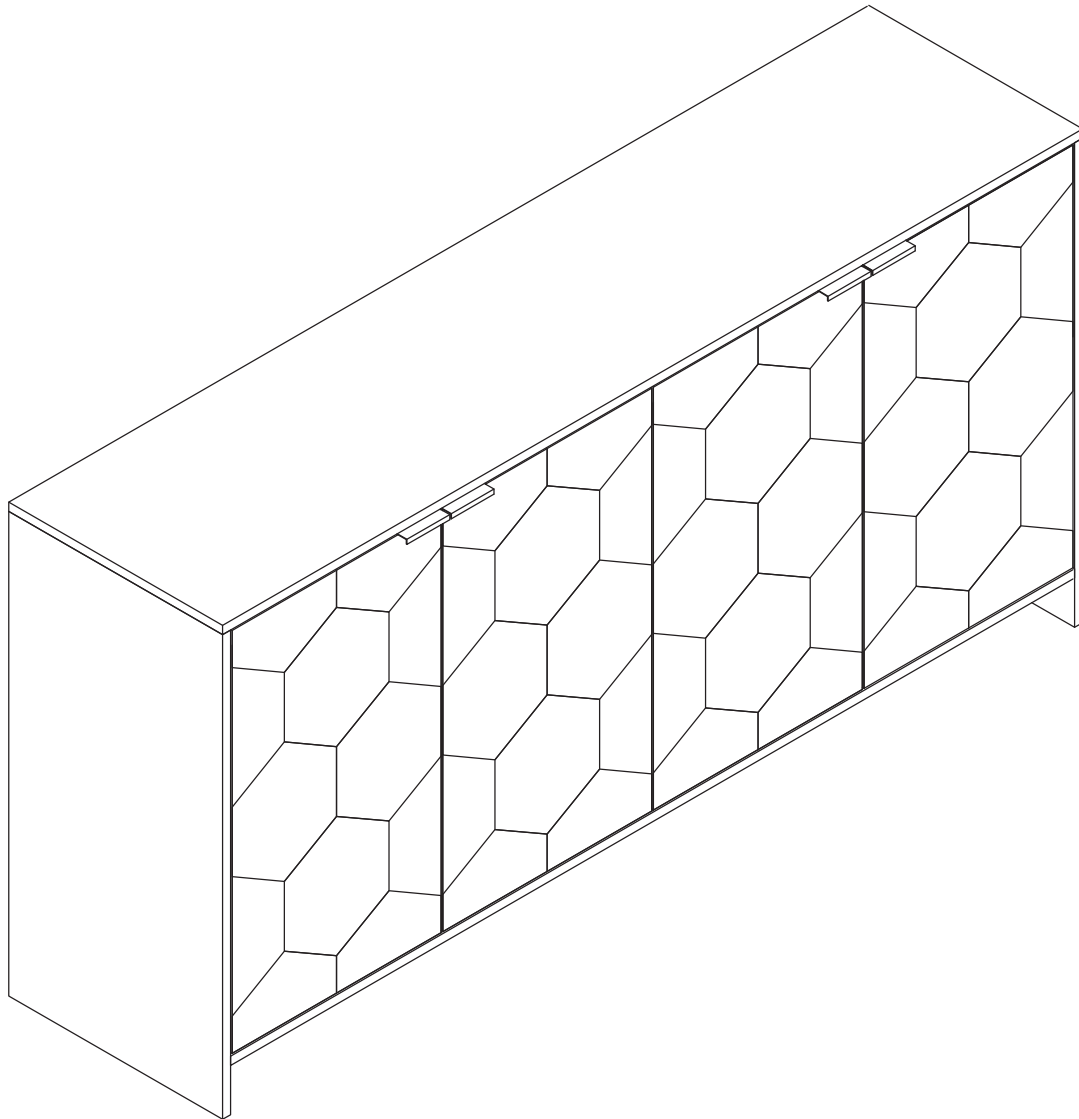

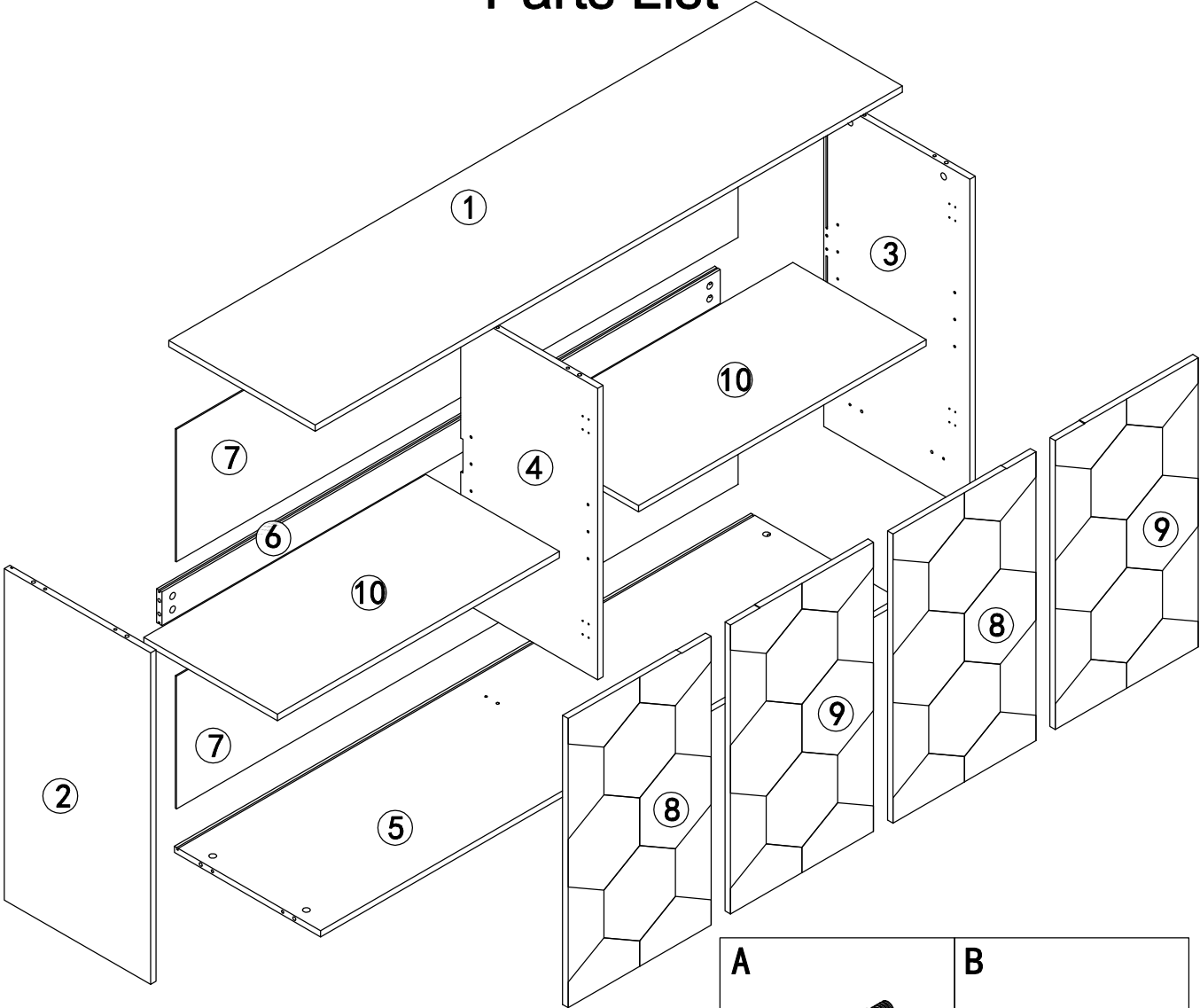







Installation & Assembly

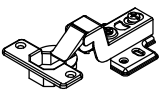

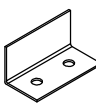
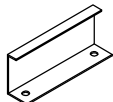
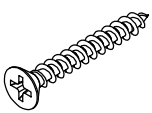
Parts List

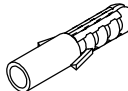
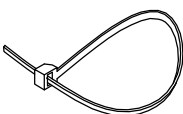
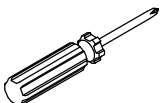
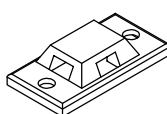
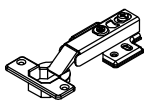

				A  16pcs		B  16pcs		
C  12pcs	D  4pcs	E  70pcs	F  8pcs	G  2pcs				
H  4pcs	I  5pcs	J  8pcs	K  2pcs	L  4pcs				
M  2pcs	N  1pc	O  2pcs	P  4pcs	Q  4pcs				

Step 1:

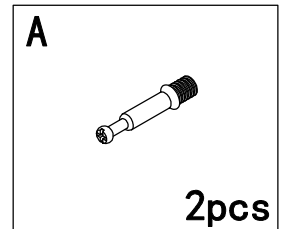
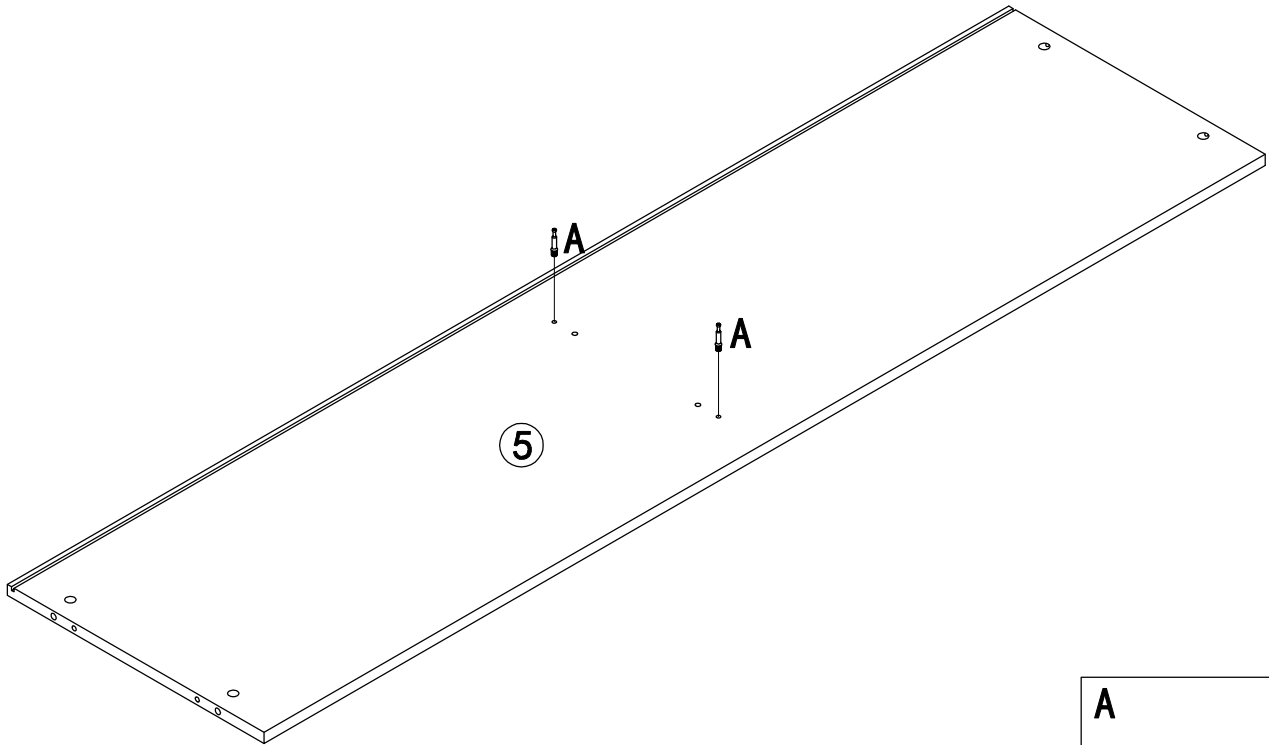

Step 2:

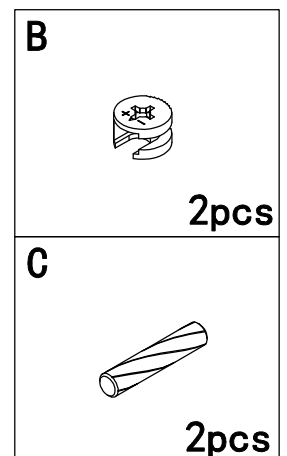
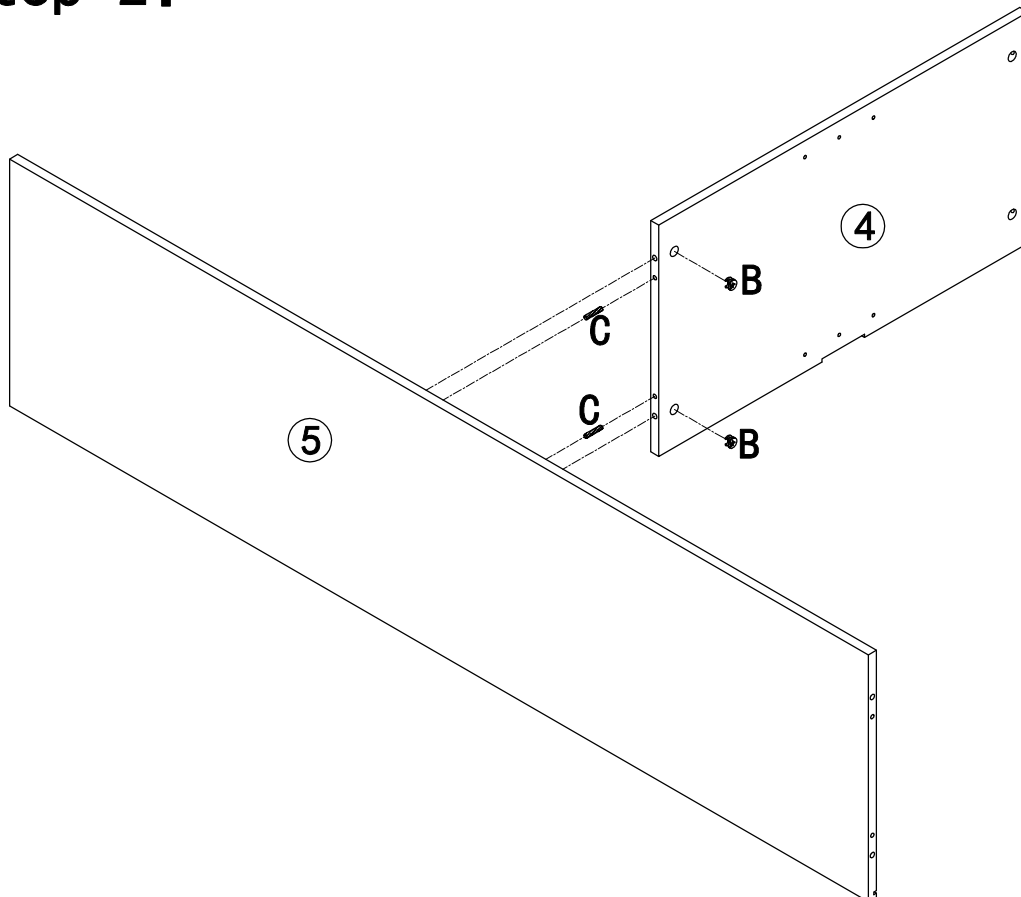

Step 3:

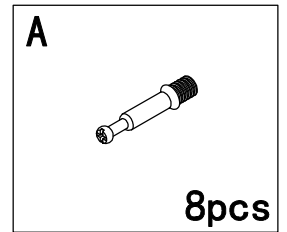
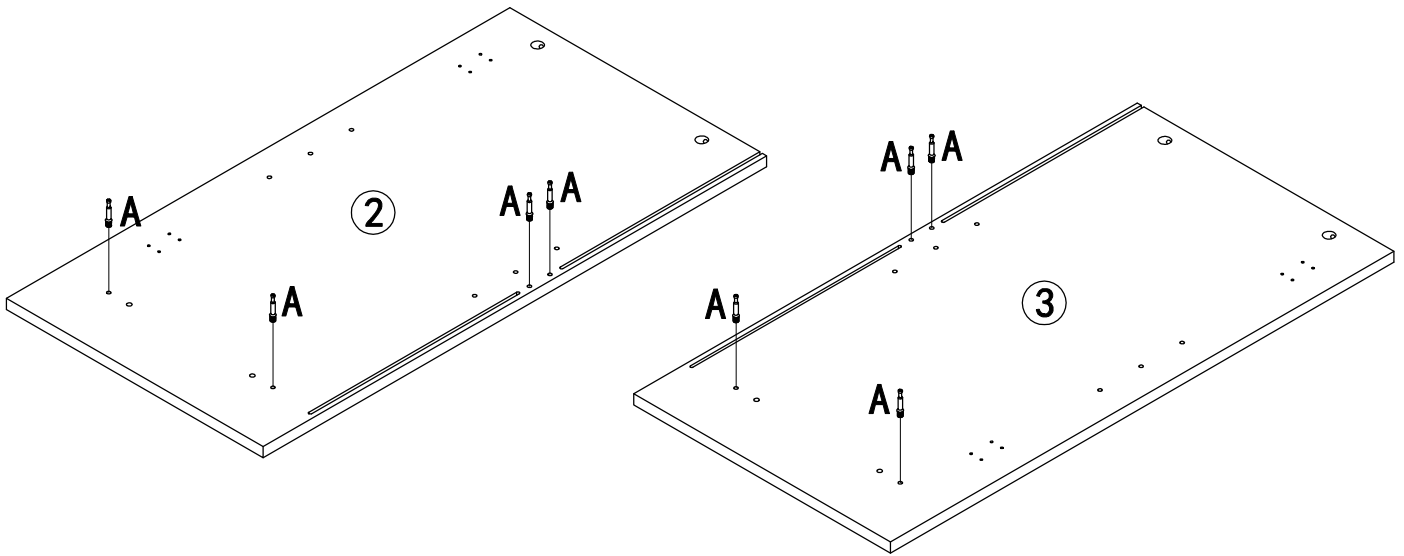

Step 4:

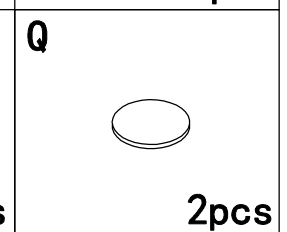
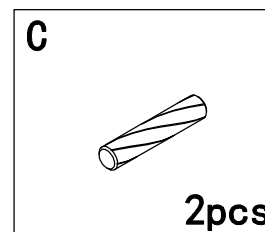
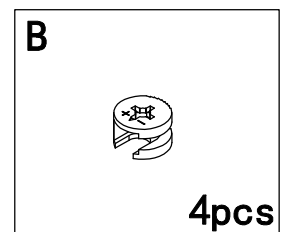
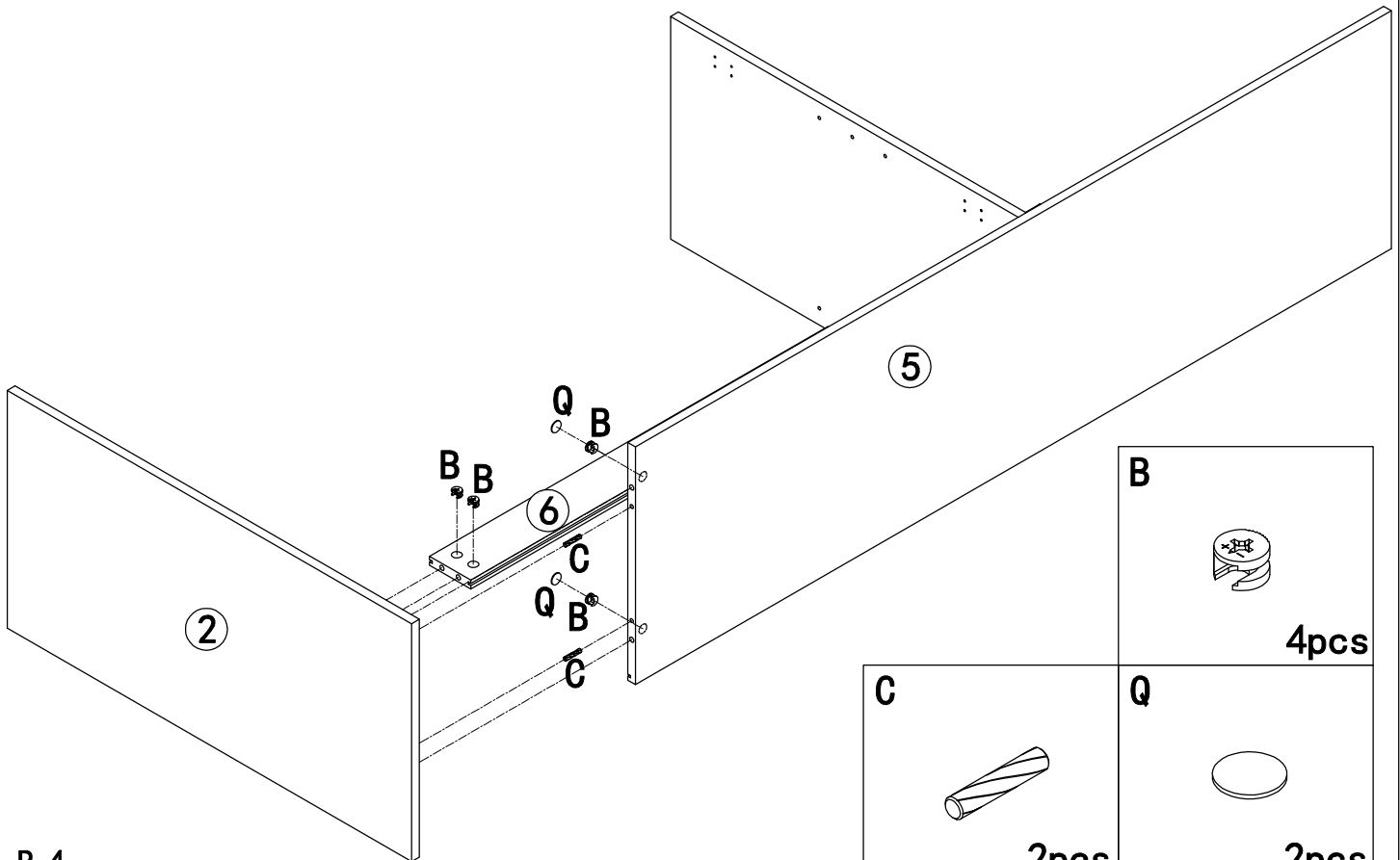

Step 5:

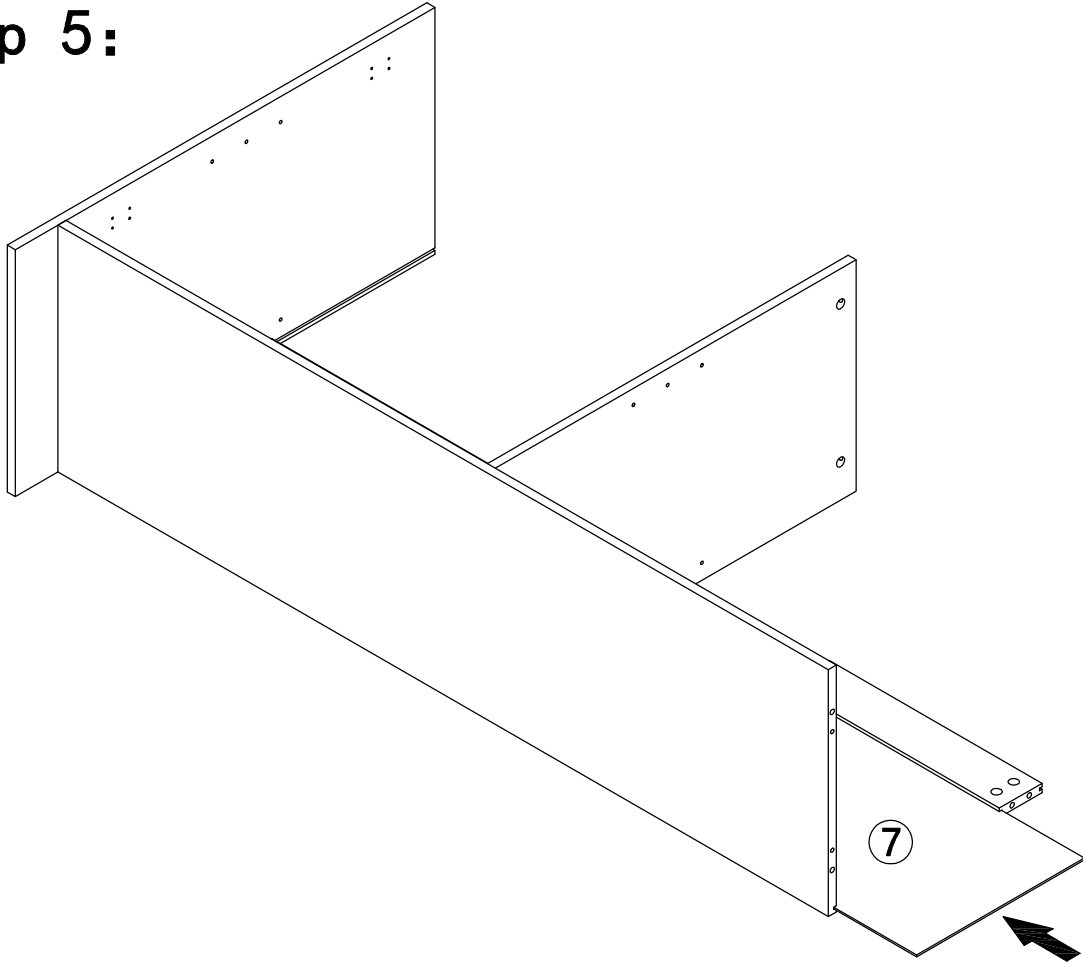

Step 6:

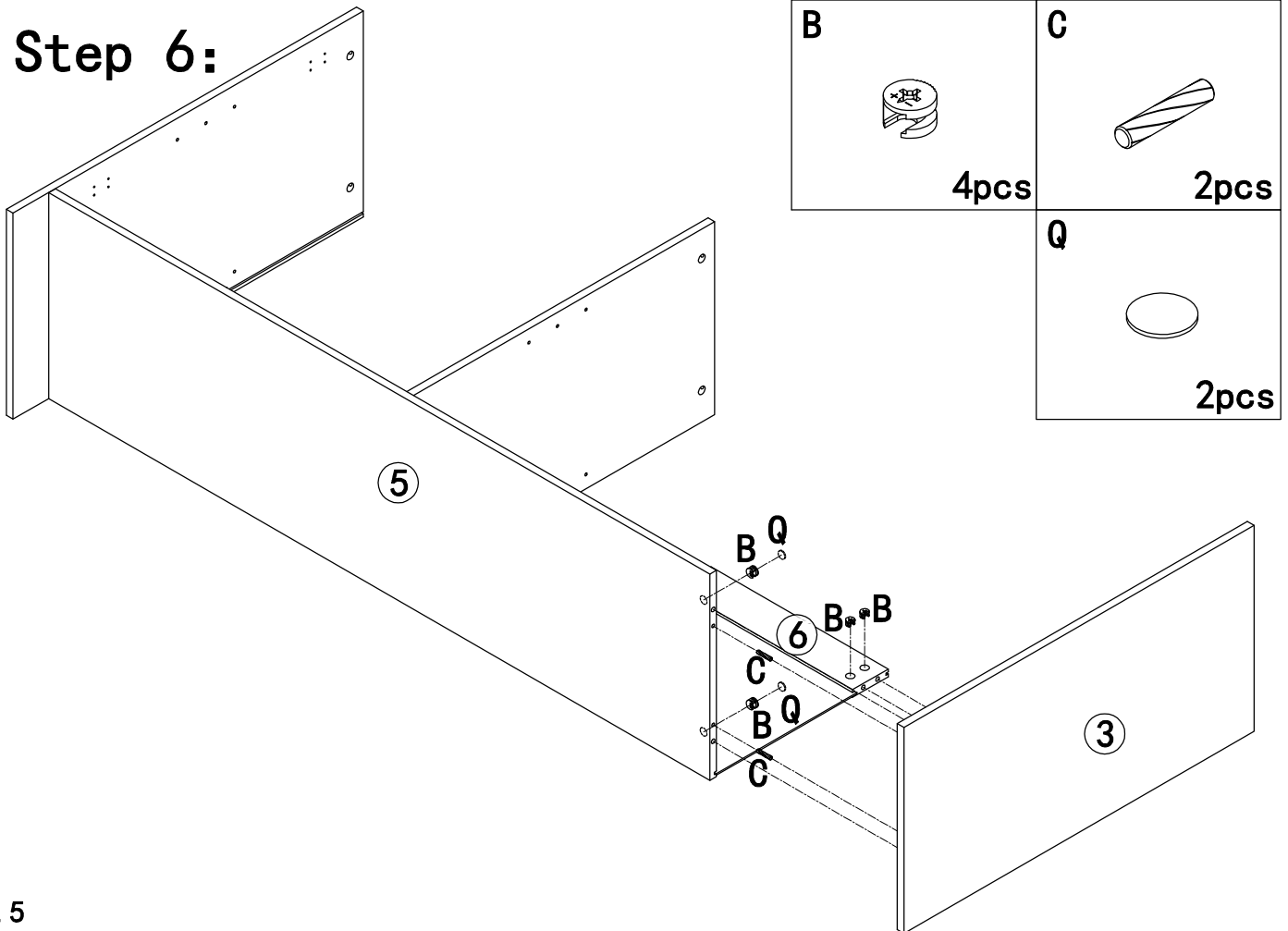

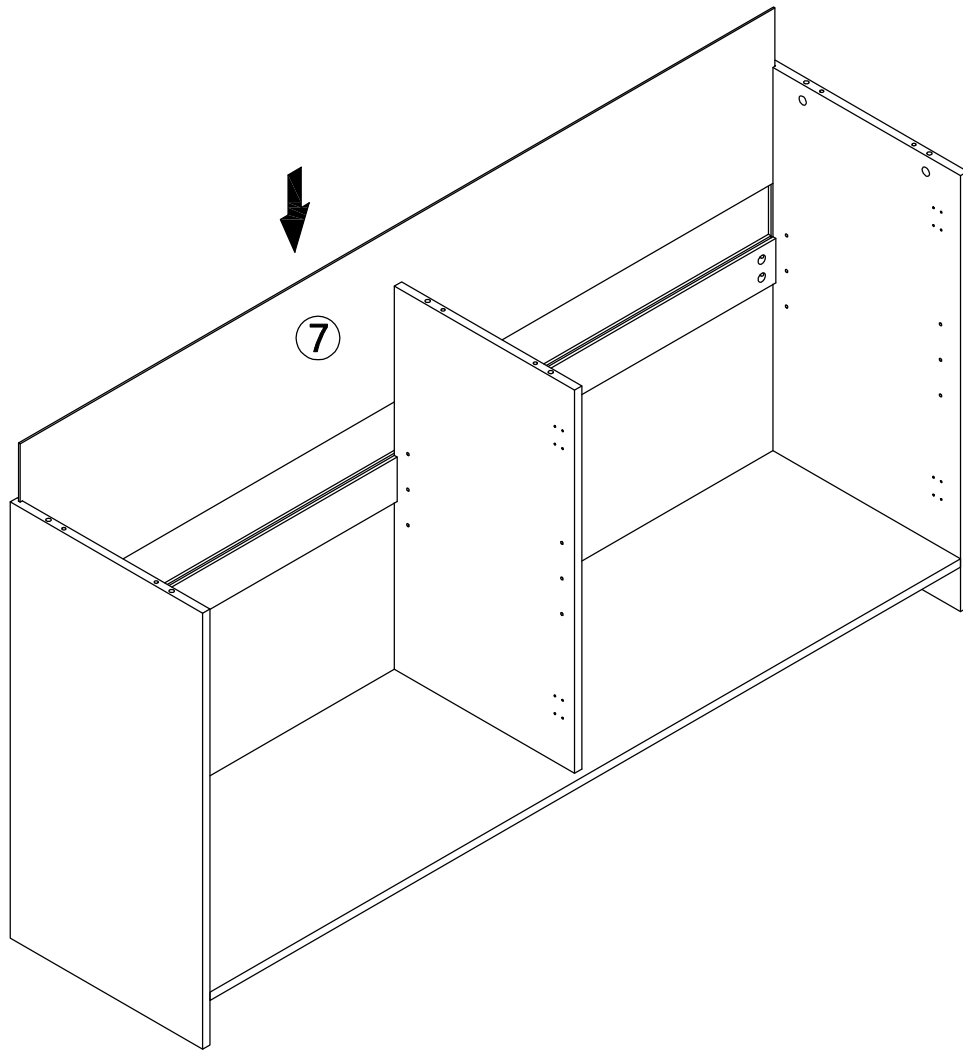

Step 7:



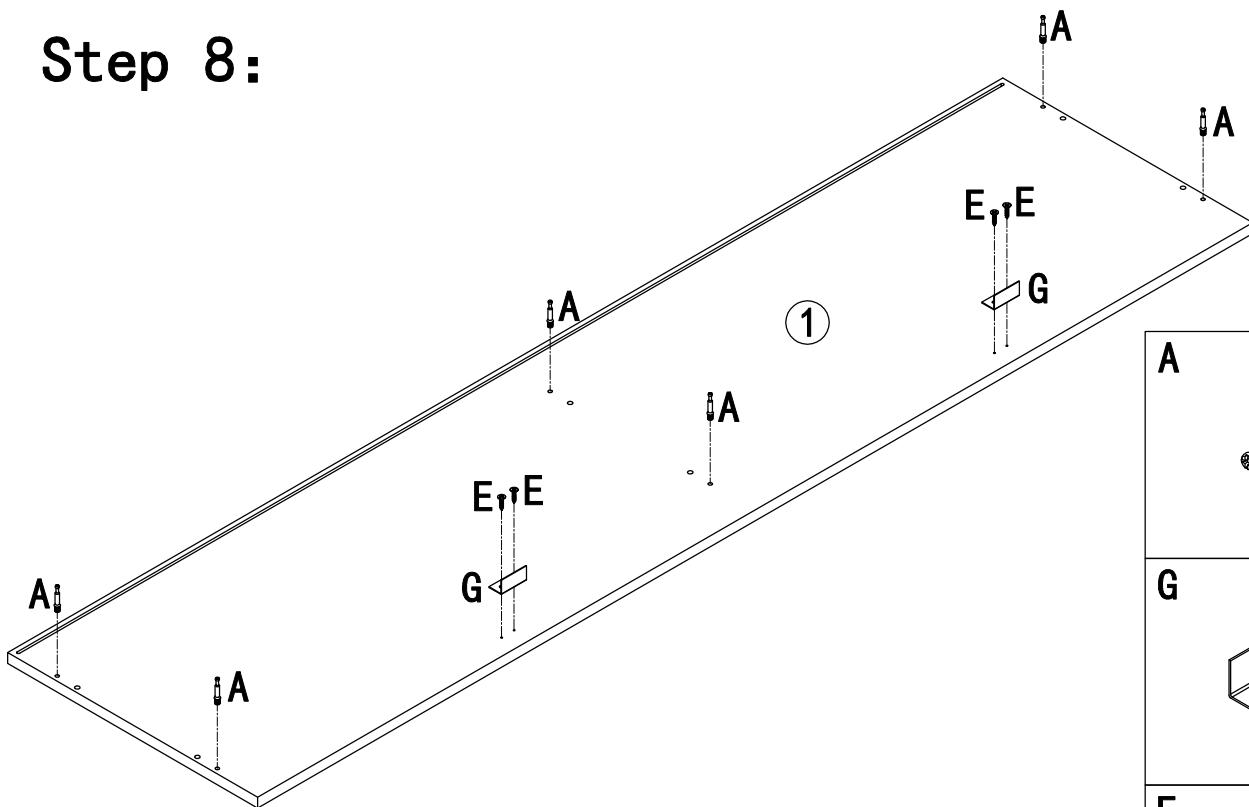

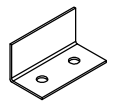
Step 8:



A		6pcs
G		2pcs
E		4pcs

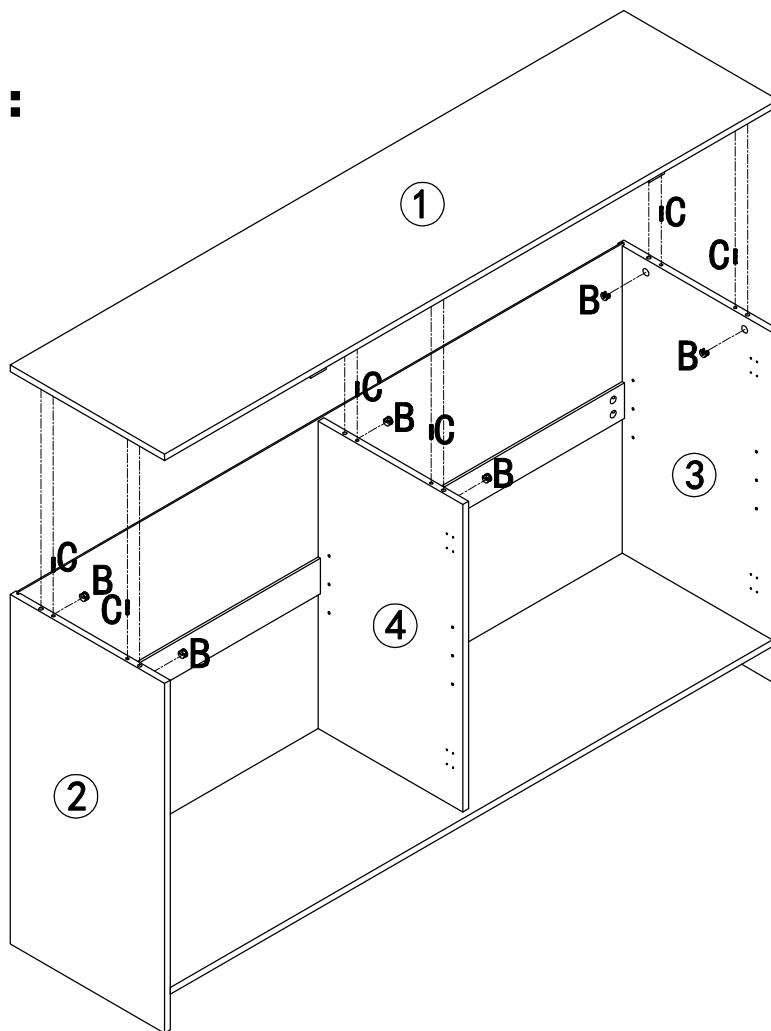

Step 9:

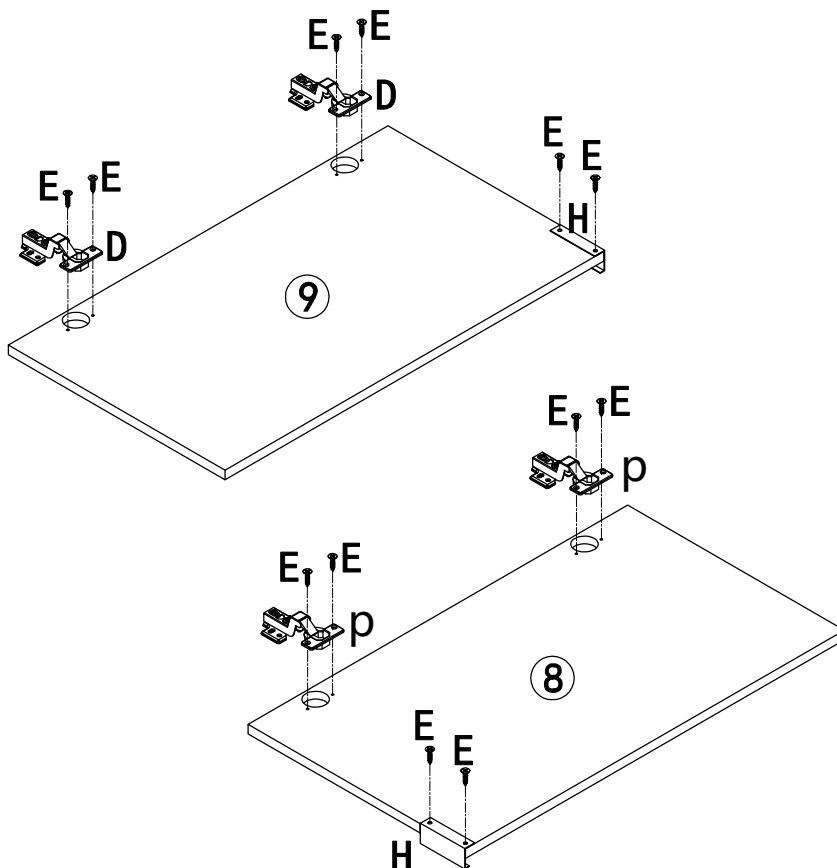

<p>B</p>  <p>6pcs</p>
<p>C</p>  <p>6pcs</p>

Step 10:

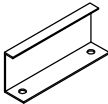
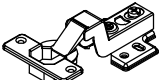

<p>D</p>  <p>2 pcs</p>
<p>E</p>  <p>12pcs</p>
<p>H</p>  <p>2pcs</p>
<p>p</p>  <p>2pcs</p>

Step 11:

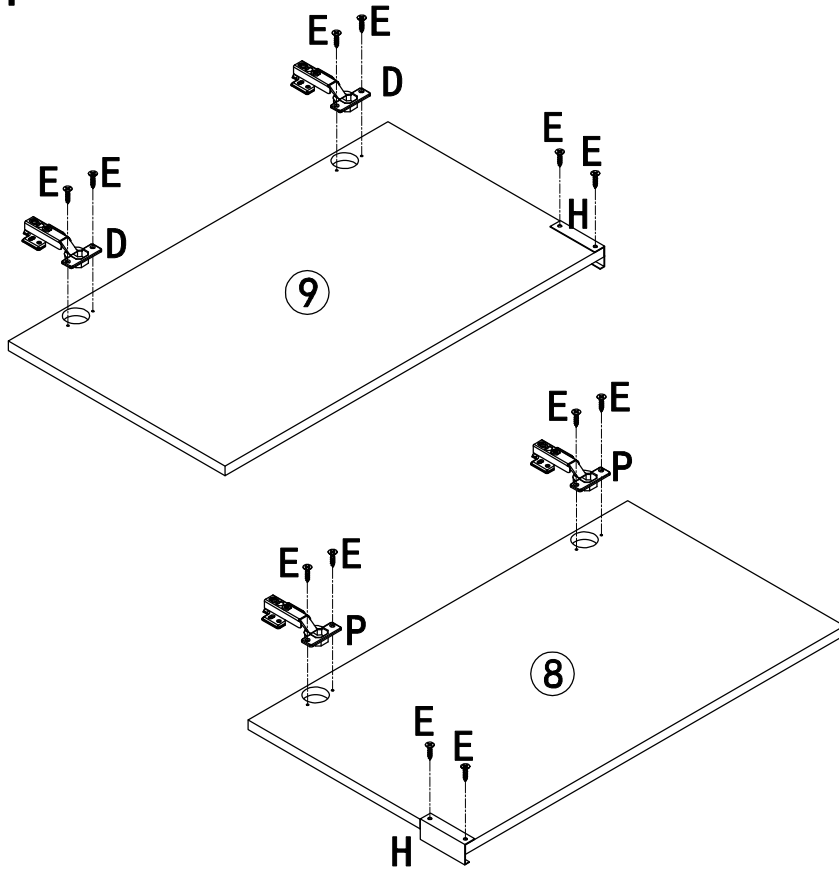

D		2 pcs
E		12 pcs
H		2 pcs
p		2 pcs

Step 12:

USE HINGE D FOR THE 2 SIDE DOORS

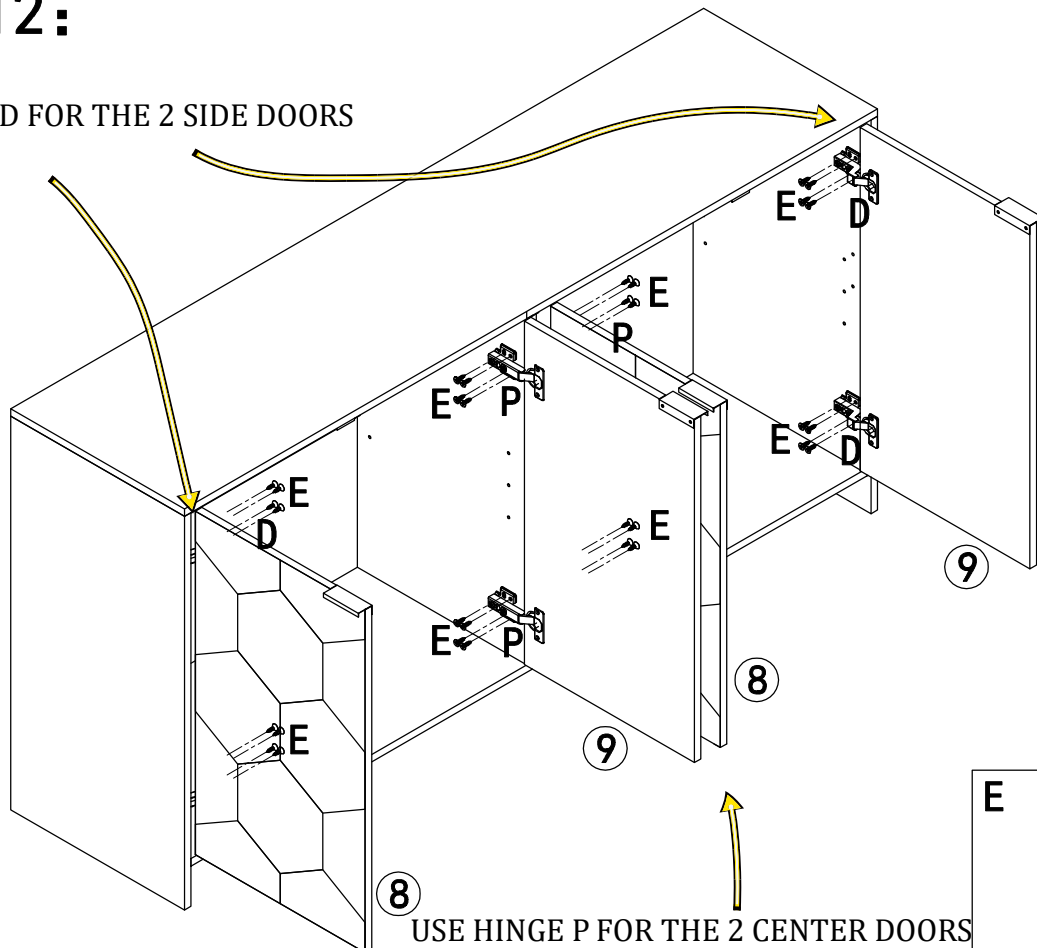

USE HINGE P FOR THE 2 CENTER DOORS

E		32 pcs
---	--	--------

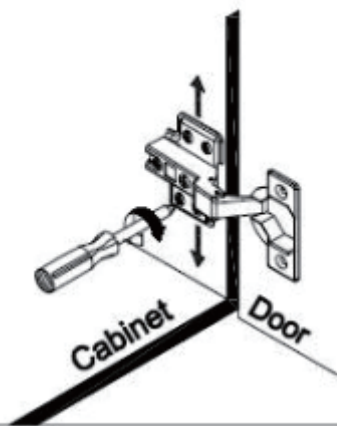
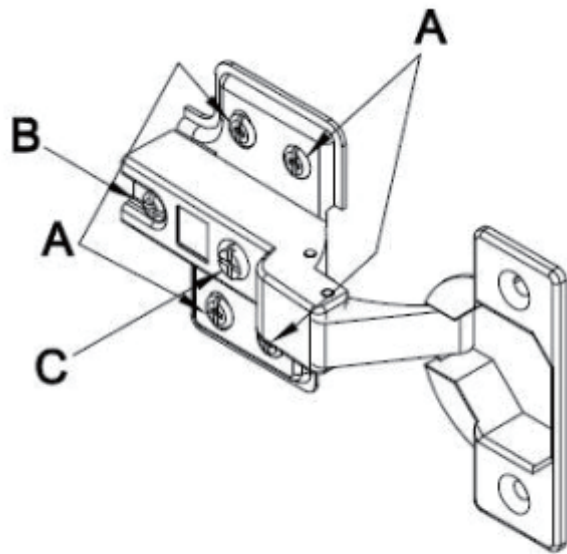

To adjust the vertical height.

Loosen the four screws "A" on both hinges. Two of them are usually in slotted holes which allows you to adjust up or down by a few mm. Then tighten back up.

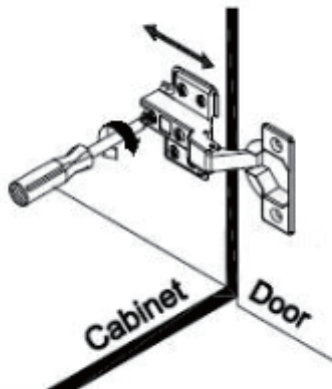

To adjust depth.

Loosen screw "B" and adjust door, if the door can not be adjusted, please loosen screw "C", then try again. Tighten screw "B" and "C".

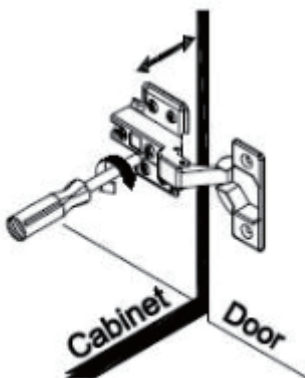

To adjust side ways.

Turning the screw "C" on BOTH hinges on each door.

Step 13:

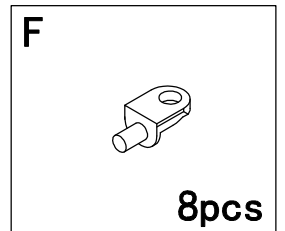
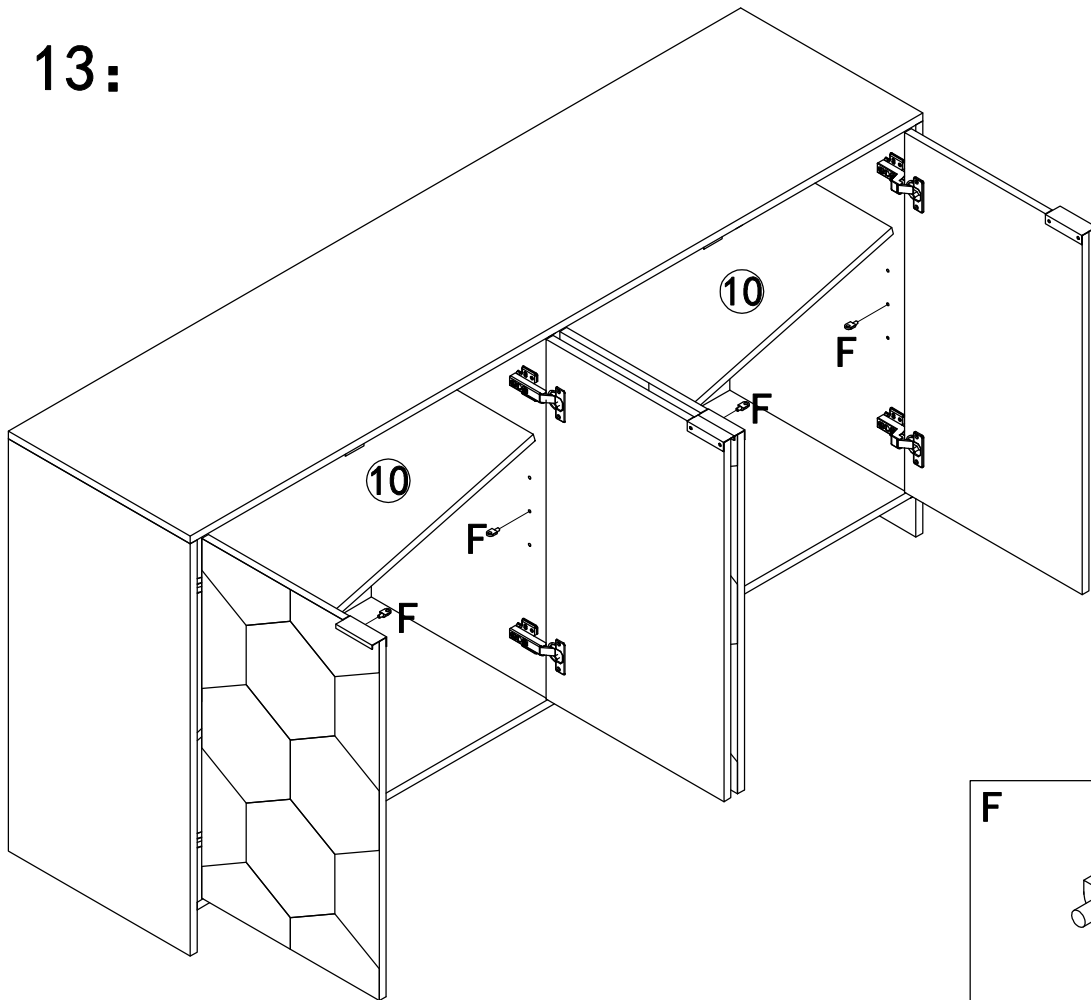



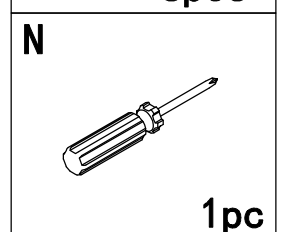
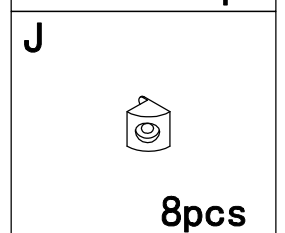
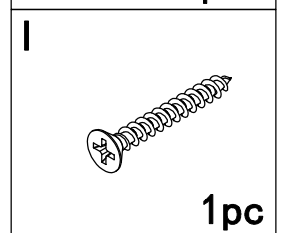
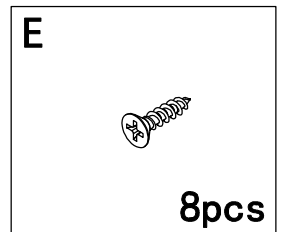
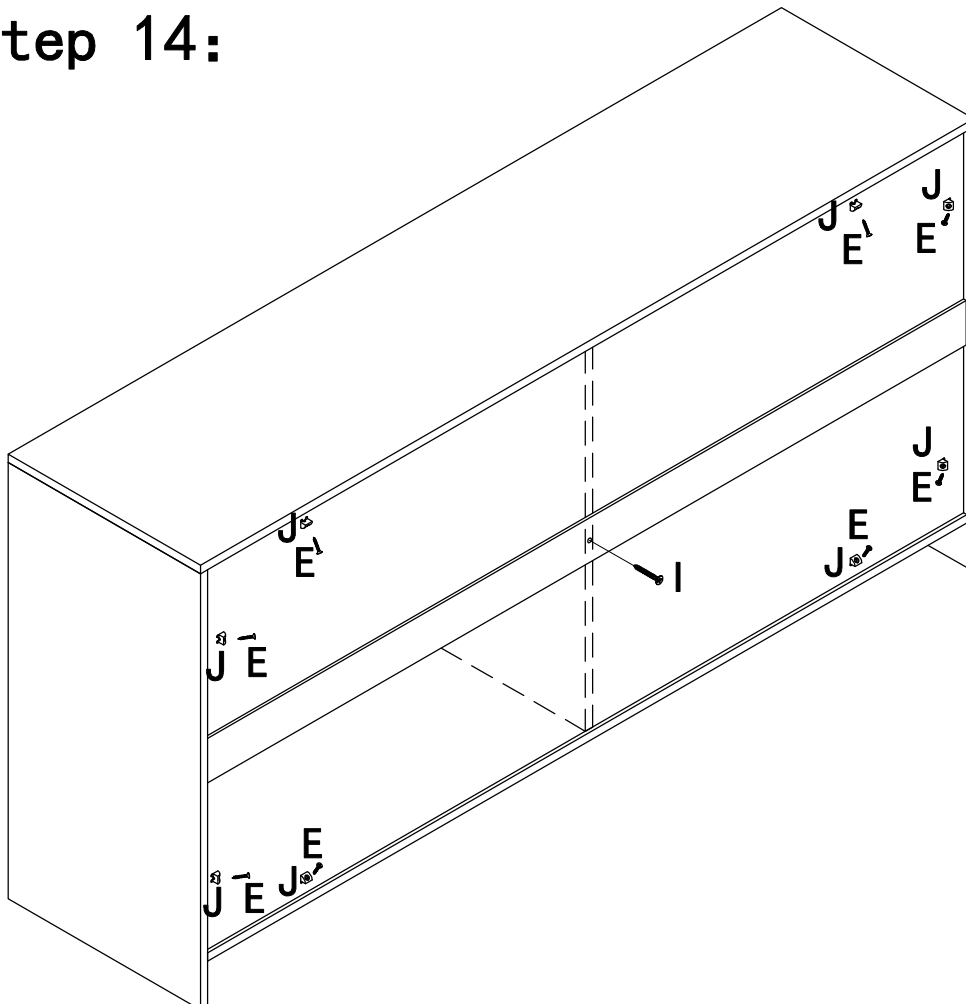

Step 14:

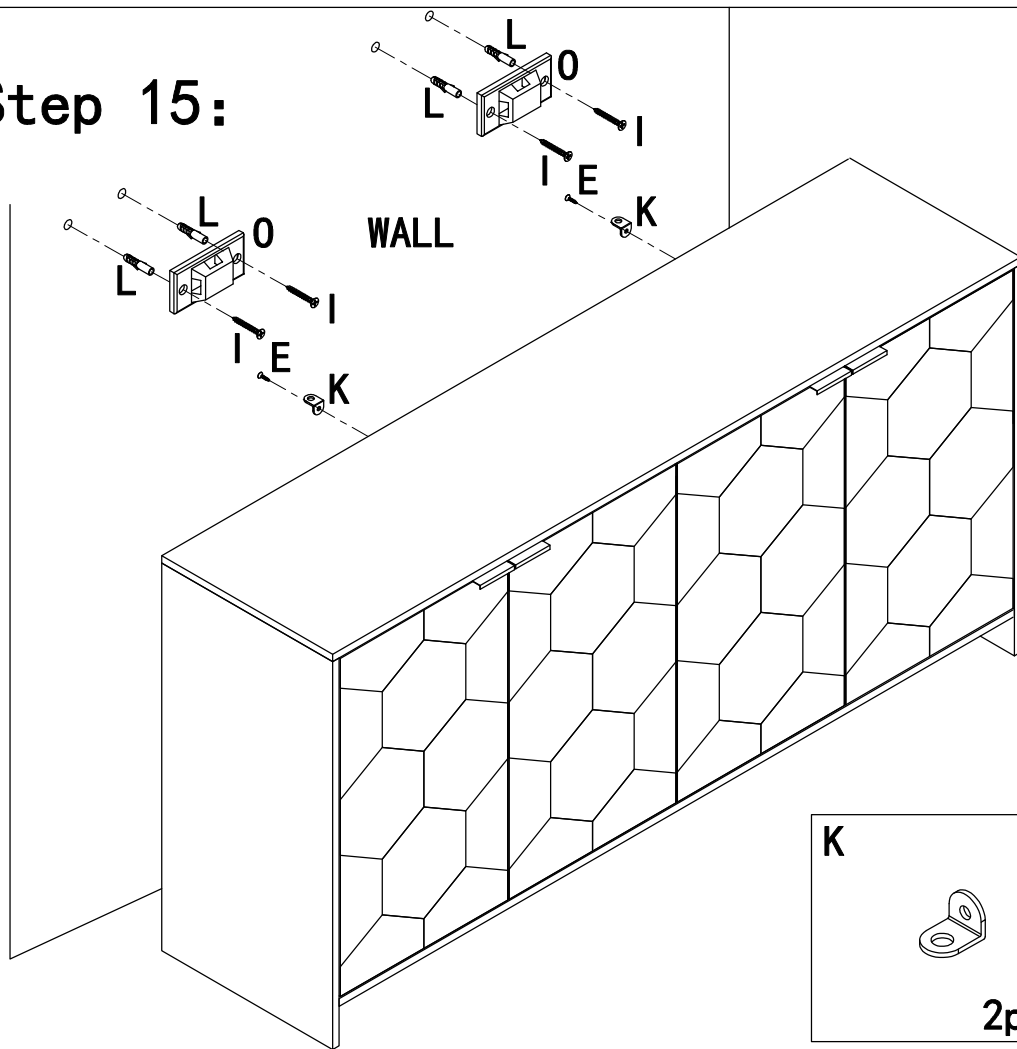

Step 15:

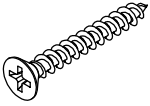

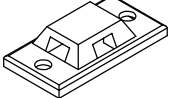
E		2pcs
L		4pcs
I		4pcs
K		2pcs
O		2pcs

Step 16:

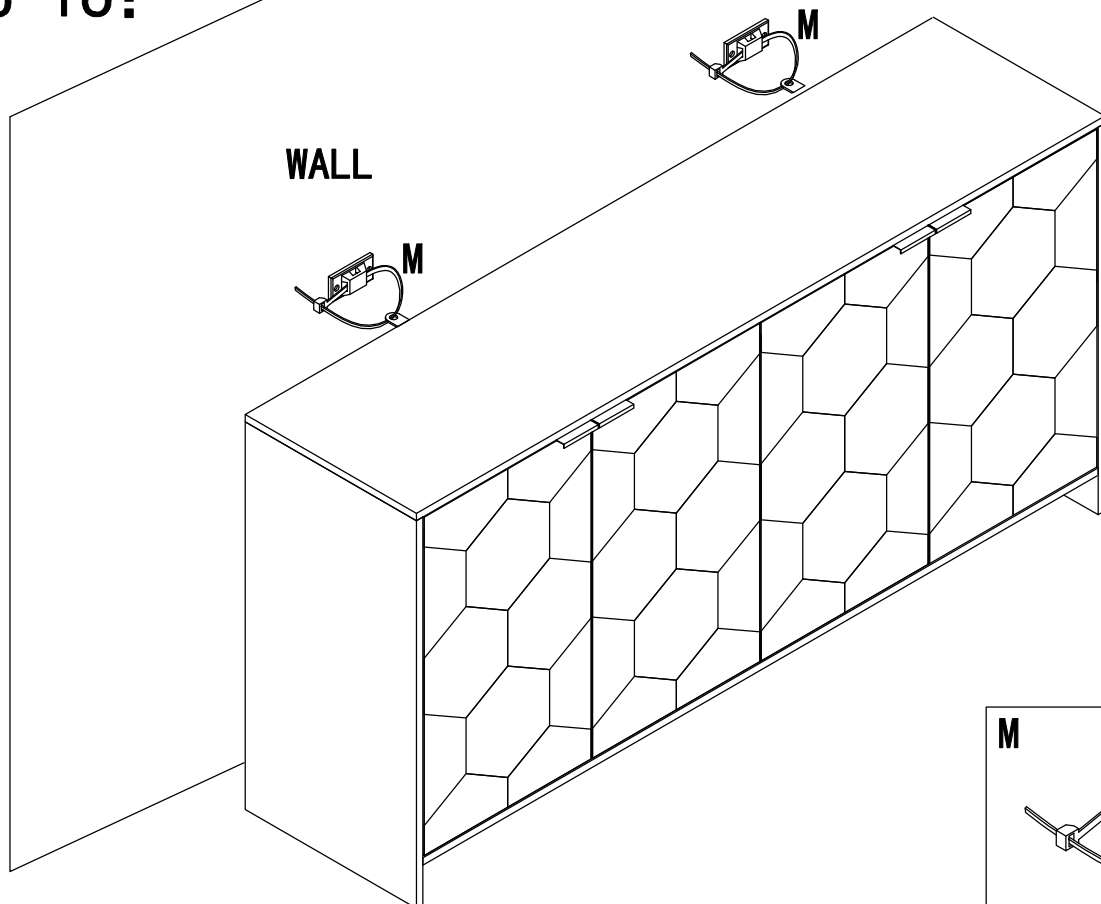

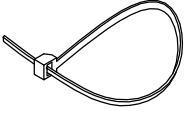
M		2pcs
---	---	------