







ASSEMBLY INSTRUCTIONS

TABLE

Thank you for purchasing this quality product. Be sure to check all packing material carefully for small parts that may have come loose inside the carton during shipment.

Parts key		
No	Q'ty	Description
1	1 Pc	Storage Box
2	4 Pcs	Leg
3	3 Pcs	Drawer Complete
4	3 Sets	Drawer Glide
5	2 Pcs	Shelf
6	4 Pcs	Floor Glide
7	3 Sets	Pull w/Screw
8	3 Pcs	Drawer stop

Hardware Kit		
No	Description	Q'ty
A	 Bolt Ø7.8 x 60	16 pcs
B	 Lock washer Ø8.5	16 pcs
C	 Flat washer Ø8.5	16 pcs
D	 Allen key	1 pc
E	 Pull	3 pcs
F	 Wooden Screws Ø4 x 20mm	6 pcs

STEP 1:

- Carefully lay the Storage box upside down on a smooth flat surface to prevent scratches.
- Affix each Leg assembly to Storage box as shown in illustration.
- Insert a Bolt (A) with Flat washer (C), Lock washer (B) through holes in wood corner of Storage Box. Do not fully tighten.

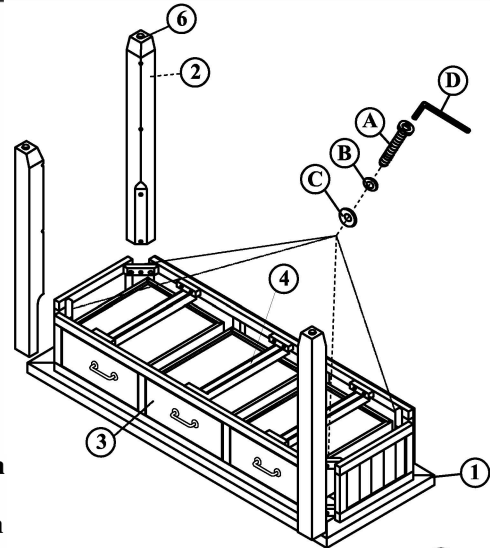

STEP 2:

- Insert the Shelf into designated locations as shown in illustration.
- Insert a Bolt (A) with Flat washer (C), Lock washer (B) through holes in wood corner of Shelf. Fully tighten all bolts with Allen key (D).
- Carefully turn Sofa/Media Table upright.

