

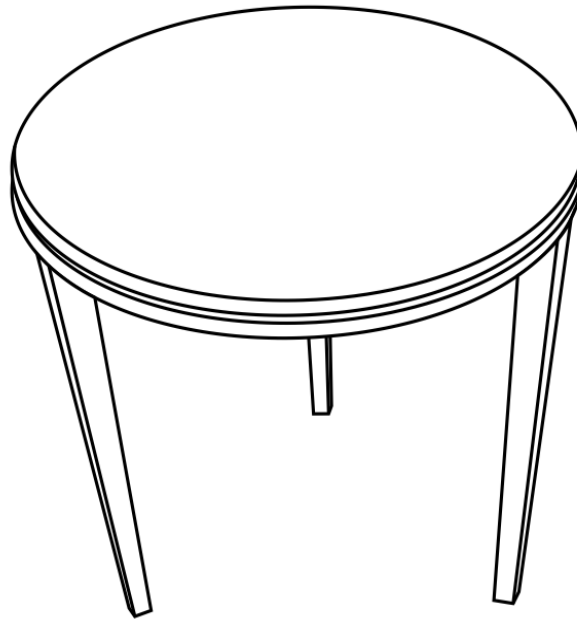

Assembly Instructions

Caution: You must read this before you proceed



TABLE

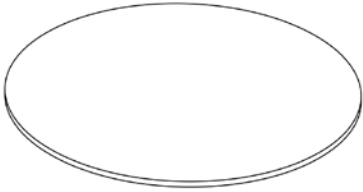
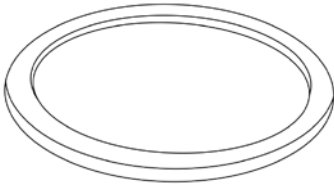

Part List

Label	Picture	Description	QTY
A		Tempered Glass	1
B		Frame	1
C		Table Leg	3

Hardware

Label	Picture	Description	QTY
①		Bolt (M6X12mm)	7
②		Sucker Cup	4
③		Allen Key	1

Assembly Preparation

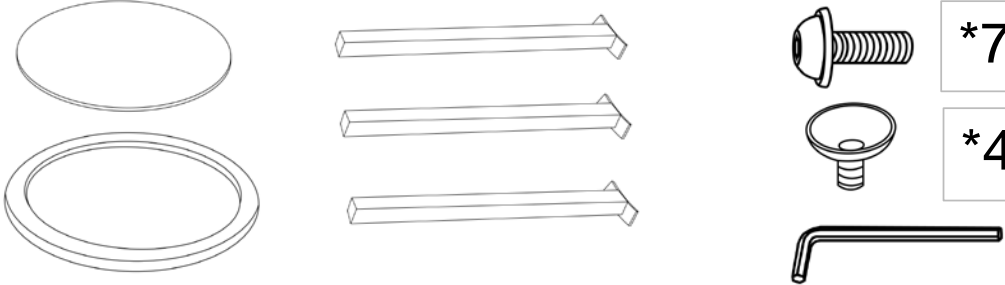
<p>Before Beginning Assembly:</p>	
-----------------------------------	---



- Read instructions, cover to cover-



- Have 2 adults on hand for assembly-



- Do not assemble on flooring or carpet-



- Assemble on a clean non-marring surface (packing foam)-



- Save all packaging until finished-

Assembly Steps

Overview

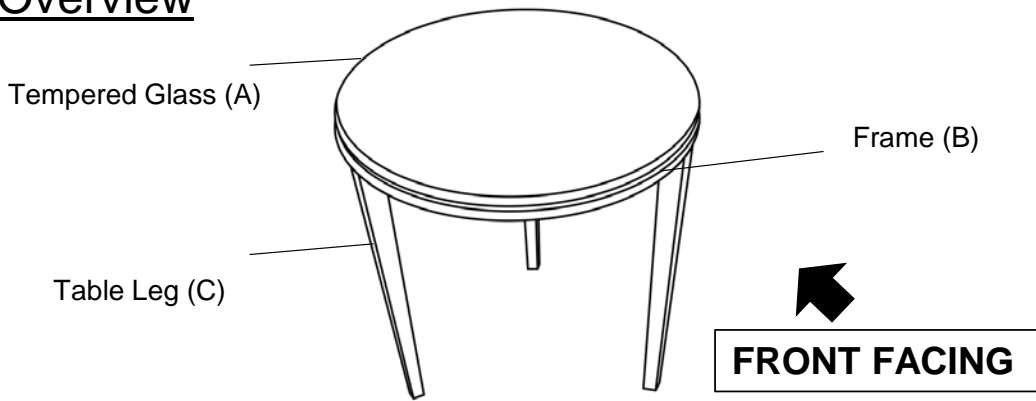

This Table has multiple parts and may require up to 30 minutes to assemble. To give you an overview of the the Table parts, the above picture is to help you put the various parts into perspective. Please read through the instructions below to familiarise yourself with the parts and steps before assembly.

Step 1

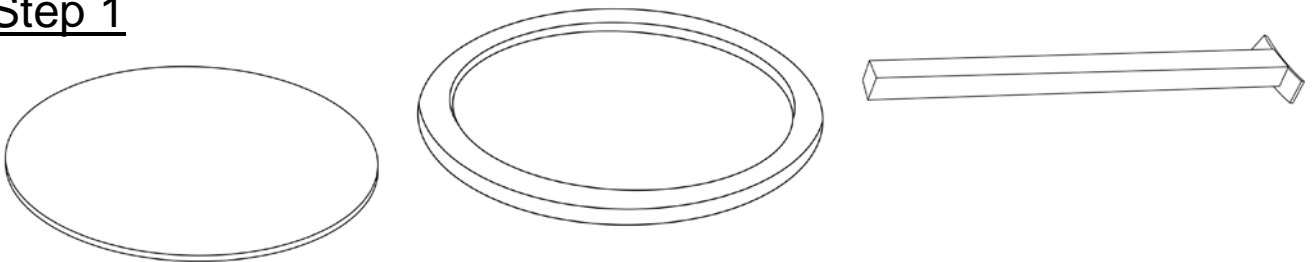

Unpack and place all parts on a clean, non-marring surface.

Step 2

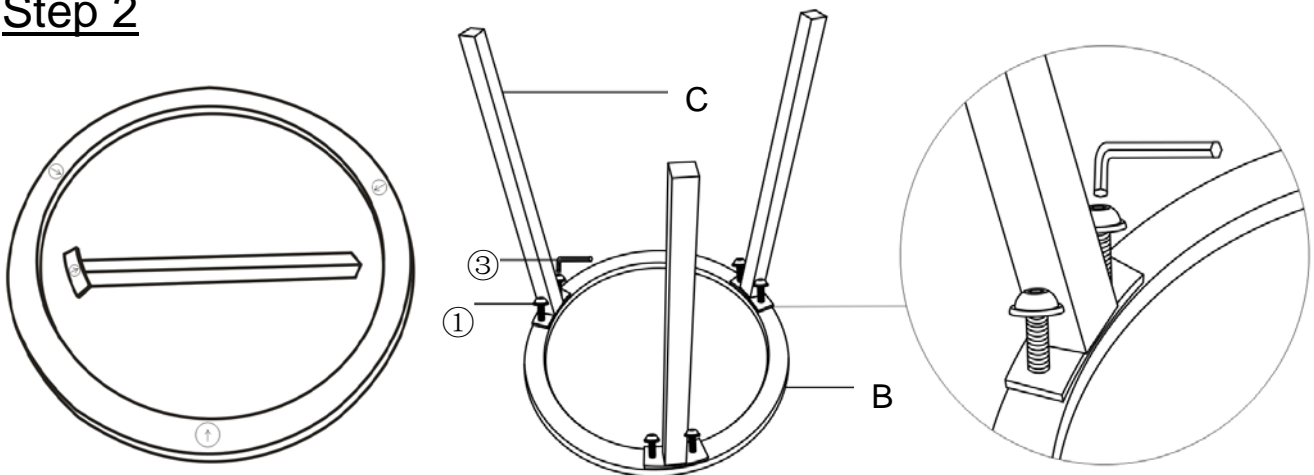

Place the Table Top (B) facedown onto a clean, non-marring surface.

Align the Table Legs(C) to Table Top(B) as shown above.

Attach Table Legs(C) to Table Top(B) using Bolts(①)with Allen Key(③).

Note: Find the sticker with the "arrow" , and place the legs in the same direction. Do not fully tighten the Bolts.

Step 3

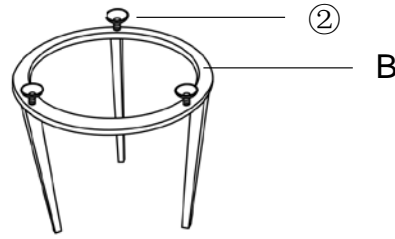

Turn over the table. Insert the Suction Cups(2) into Table Frame(B) as pictured above.

Step 4

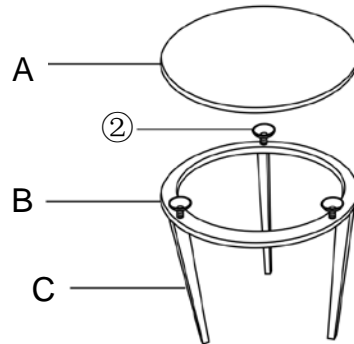

Carefully place the Tempered Glass(A) on the Table.



Carefully exert pressure floorwards onto the Table using both your hands. This pressure will help the Legs and Table Top reach full alignment status. Check for wobbles on a LEVEL surface. If no wobbles are found proceed to tighten the Bolts in a sequential manner, until evenly secured.

When tightening the Bolts tighten sequentially.

Do not tighten any Bolt fully and then move on towards the next one.



















If there are still wobbles, loosen the Bolts and execute the same above process.



Your Table is ready for use.

This Table can only be used on a flat and level surface.

Care & Maintenance

-   ● Do not put hot items directly on furniture surface
 -   ● Do not clean furniture with harsh cleansers or polish.
 -   ● To obtain the longest lifespan of your outdoor products, minimizing exposure to direct sunlight is recommended.
 -   ● Children should not climb or jump on the furniture.
 -   ● Do not write on furniture without a padded barrier to protect the surface.
 -   ● To obtain the longest lifespan of your outdoor products, avoid extended and lengthy exposure to rain, snow, and direct sunshine. Whenever possible cover the product and /or place under patio or awnings.
 -   ● Not for commercial use. For residential use only .
 -   ● Stains may be removed with mild soap solution and damp cloth.
 -   ● Keep away from sources of ignition.
-
-   ● Dust and pick-up spills using a clean, non-colored, lint-free cloth.