

Global Home

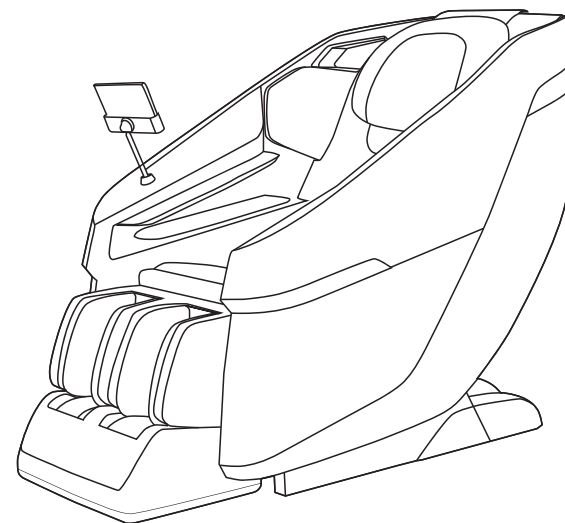

Stylish Massage Chair

82232/F2232
User Manual

Please read all instructions before use

11 Product maintenance

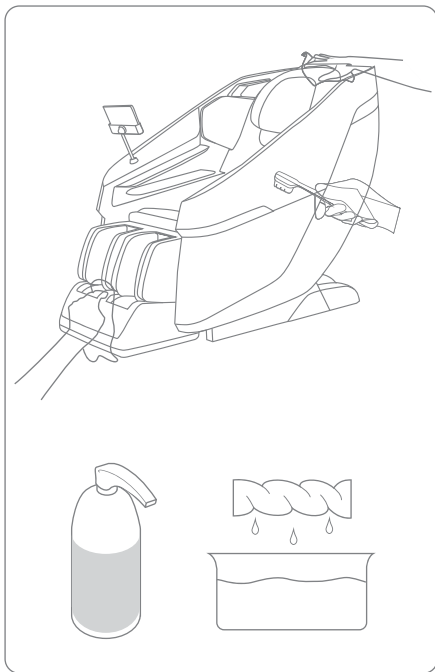

Clean

Do not use steel wool, abrasive cleaners or corrosive liquids (such as gasoline or acetone) to clean the product.

- 1 Unplug the plug from the power socket.
- 2 Clean the massage chair, remote control and power cord with a dry cloth.
- 3 Do not use a damp cloth or detergent.

Store

- 1 Unplug the plug from the power socket.
- 2 Store this product in a cool and dry place away from sunlight.
- 3 Do not place heavy objects on the product.

If the leather case is damaged or mechanical failure, please stop using this product and inquire from the authorized after-sales service center or customer service center in your country(region).

If you do not use it for a long time, please unplug the power cord!

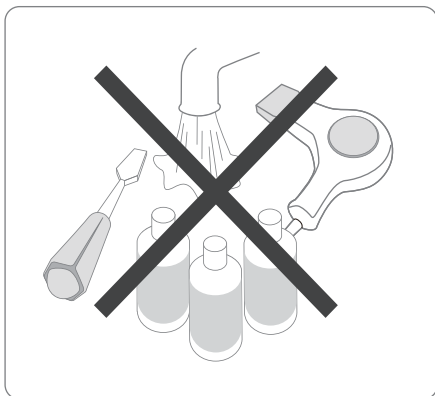

If massage chair does not operate or if parts are missing, call:

1-800-892-8075

Do not contact retail store or dealer.

01 Preliminary Checks

(1) Unpack the carton and take all massage chair units out of the carton.

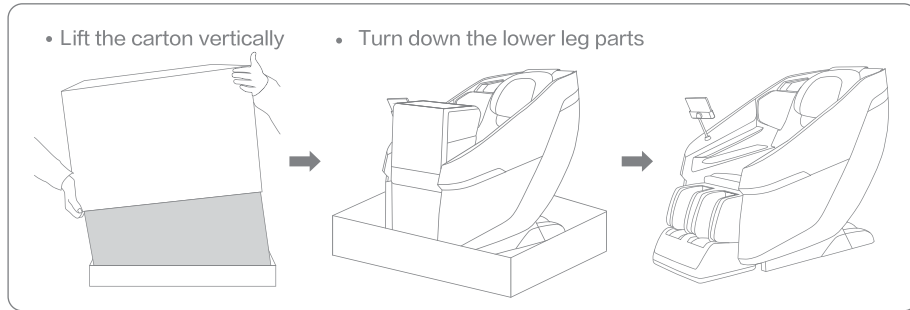

1. Remove secure straps and lift the carton vertically.
2. Take all accessories out of the cartons.

(2) Placing the massage chair

- * Carry the massage chair out of the carton and place it at desired location.
- * Do not put this product near heat source, open flame or in direct sunlight, this may cause fading or damage.
- * The bottom of the massage chair may scratch the floor, we recommend placing a piece of carpet or soft mat underneath it to avoid damaging the floor.
- * Please allocate clearance to the front and back (a minimum 26-centimeter clearance behind the backrest) of the product.
- * Do not put the massage chair in high moisture or on uneven floor.
- * Keep it 1 meter away from the TV, radio or other audio/video appliance to avoid signal interference.

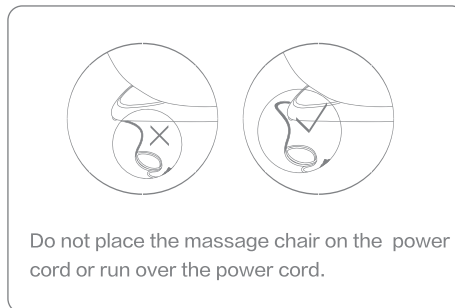
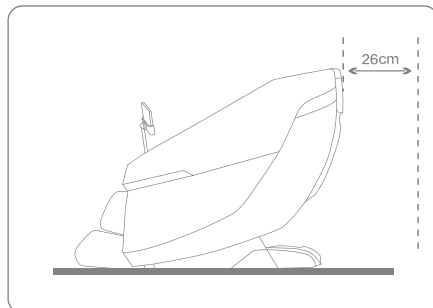

Warning

- Those who are not allowed to use this product: those who are physically, emotionally, or mentally defective, or who lack experience and knowledge. Unless they are supervised or instructed by the person responsible for their safety regarding the use of the product.
- Children should be supervised to ensure that they do not play with the massage chair.
- If the power cord is damaged, it must be replaced with a special cord or a special component purchased from its manufacturer or maintenance department.
- The surface of the appliance heats up, so people who are not sensitive to heat must pay attention to it.
- Do not use this machine under a voltage that does not meet the standards of this machine.
- This product must use a grounded three-core power socket, and there should be a reliable and good grounding device.
- Damaged leather or cloth covers should be replaced in time. Do not use this machine to avoid personal injury.
- Do not allow water or moisture to enter the hand controller to avoid control failure.

10 Troubleshooting

Possible situation	Possible solutions
The sound made during operation.	The sound produced by the structural design will not affect the machine.
The power is plugged in, but the massage chair cannot be operated.	Check if the power head is plugged in or powered on. Check whether the power switch of the massage chair is in the "I" position. Check whether the power cord is damaged. Check that the fuse is damaged and replace the fuse. Check whether the manual control line is inserted well and screwed.
The backrest cannot be raised and lowered freely.	Check whether there are foreign objects stuck in the backrest and lower legs.
During use, the controller can be operated, but the massage chair cannot be operated.	After a long period of operation, if the temperature of the machine is too high, the massage chair will be automatically in the temperature protection state, please turn off the power and wait for 30-50 minutes to let the internal heat dissipation of the machine.
During use, the controller cannot be operated, and the massage chair also stops operating.	After the automatic timing function is activated, if the set time is up, please press the button again to control it.
If an abnormal situation occurs, in order to prevent accidents, please stop using it and unplug the power cord. If the above-mentioned solutions are still invalid, please contact the after-sales service center.	

09 Safety Precautions



Warning

Please read all instructions before use. this massage chair must use a socket that matches the plug. incorrect grounding may cause electric shock. please do not modify the plugs and sockets without authorization, and be sure to entrust professional technicians to inspect them. when using electrical products, in order to check the risk of electric shock, burns, fire, or personal injury, basic safety precautions should be followed, including the following:

- be sure to use an outlet that matches the plug.
- make sure that the plug is fully inserted into the socket to reduce the risk of short circuit or fire.
- be sure to unplug the plug in time, after use or before cleaning.
- do not use this product at high temperatures.
- do not store or use this product outdoors or in direct sunlight.
- if there is a sudden power failure during use, please set the switch “O” position immediately, and unplug the plug to avoid damage to the product when a call comes in.
- do not operate the massage chair if the cord is wet or damaged.
- do not insert or unplug the plug with wet hands to avoid accidents.
- when a child or an handicapped person is near or using a massage chair, someone must be present to look after him.
- only use this product for purposes described in this manual.
- do not use accessories not provided by the company.
- do not stand, sit or jump on the calf rest, so as not to cause damage.
- please do not try to sit on the armrest or backrest, so as not to tip the massage chair over and cause an accident.
- do not go to sleep during the massage.
- please keep the massage chair clean and avoid inserting other objects into the gaps of the massage chair.
- do not move the massage chair directly by pulling the power cord.
- before use, check whether there are abnormal cracks in the flannelette of the backrest of the massage chair.
- the product is designed for home use only.
- when you are not sure whether you can use the massage chair, please consult your doctor.
- in order to avoid discomfort or injury caused by using this massage chair, the following people should consult a physician before using this product; those receiving treatment, those with back disease, those with abnormal or distorted cervical spine.
- if you feel pain during use, please stop using it immediately. If it is damaged during use, please seek medical attention immediately.
- do not massage red, swollen or inflamed skin.
- this product only provides comfortable massage enjoyment for the family. It is not a professional massage medical device, so it cannot replace professional treatment.
- it is recommended to use the massage chair for 30 minutes a day, and massage the same part should not exceed 15 minutes, otherwise excessive massage will result in counterproductive effects, and long-term use will cause the massage chair to overheat and shorten the service life of the product.
- do not use this product in an environment where gas or oxygen is used.
- this product is not suitable for children under 12 years of age.

02 Structure

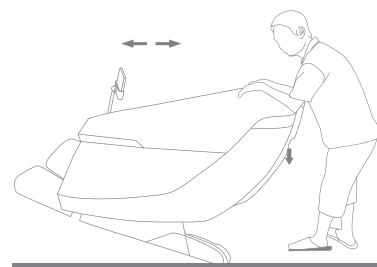
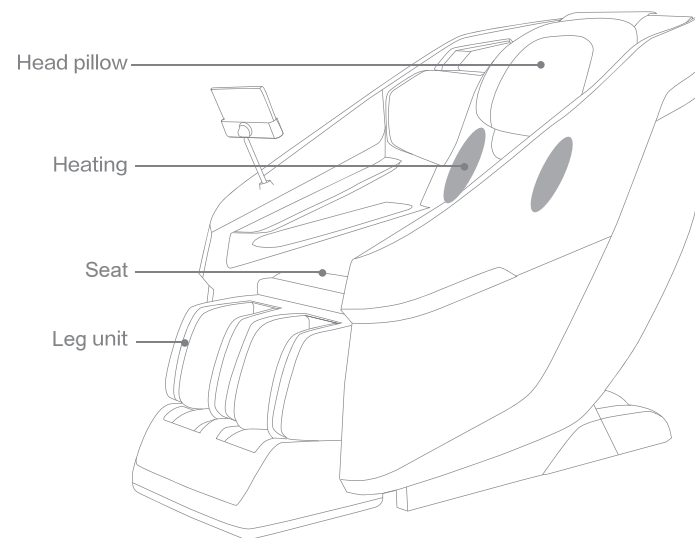

Moving the massager chair

1. Push down on the backrest and tilt the chair about 30 degrees.
2. Roll the chair on its casters to the desired location.



Caution

- * Do not move the chair when there is user inside.
- * Moving the chair may scratch the floor, we recommend placing a piece of carpet or soft mat underneath it.
- * Please hold the backrest firmly when moving the massage chair to avoid falling.
- * Make sure the footrest is fully retracted when moving the massage chair to avoid damage.

03 Structure

Back of massage chair

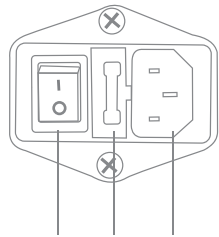
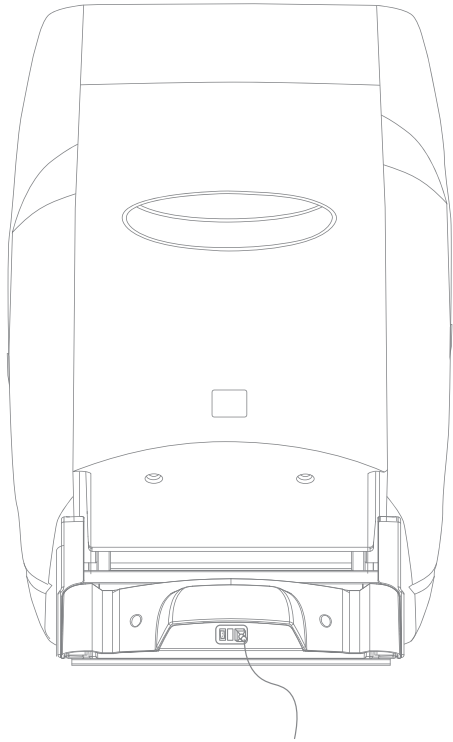

Power switch Fuse Power socket

08 Technical Specifications

Items	Specifications
Name	Stylish Massage Chair
Model	82232/F2232
Rated voltage	110V- 120V~
Rated frequency	50/60Hz
Rated power	70W
Packing dimension	1180mm(L)x740mm(W)x1060mm(H)
Weight	N.W.:65 kg G.W.: 76 kg
Safety design	Class I
Default working time	20 Minutes

07 How to Use

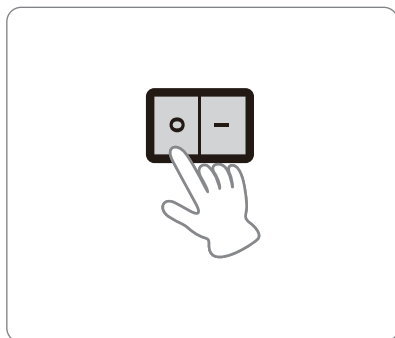

The switch is on the back cover of the power box

- 1 Press the power switch at the armrest to stop all massage motions.
- 2 When not in use for a long period of time, be sure to turn off the power switch.
- 3 Disconnect the power cord from the electrical outlet. Do not drag the power cord to avoid damage to the cord, leading to fire or electric shock.

Bluetooth Connection

- * When the massage chair is on, the bluetooth is on as the default setting, you may turn on bluetooth on your mobile device, choose "A36" to pair.
- * You can enjoy music when bluetooth is connected.

04 Controller instructions

Tablet controller

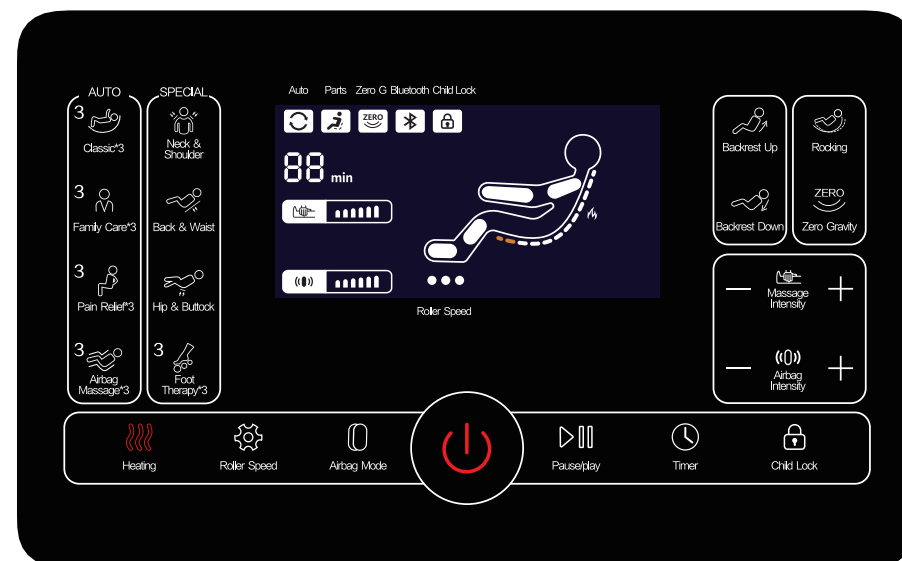

05 How to Use

Controller Instructions



Power button

Press the power button to turn on the product, the controller screen lights up. Choose a massage program to start. Press the power button again to turn off the power and restore when the product is working.



Classic*3

Press this button to toggle among three classic auto program: chinese kneading, thai massage, healthy breath.



Family Care*3

Press this button to toggle among three family care auto program: queen slimming, man's massage, senior's joy.



Pain Relief*3

Press this button to toggle among three pain relief auto program: neck & shoulder, back & spine, waist & hip.



Airbag Massage*3

Press this button to toggle among three air massage auto program: kneading massage, pulse massage, alternating massage.



Neck & Shoulder

Press this button to choose neck & shoulder mode.



Back & Waist

Press this button to choose back & waist mode.



Hip & Buttock

Press this button to choose hip & buttock mode.



Foot Therapy*3

Press this button to toggle among three foot therapy program: energy mode, relax mode, sleep mode.



Backrest Up

Press and hold this button to raise the backrest and recline the legrest, release the button to stop.



Backrest Down

Press and hold this button to recline the backrest and raise the legrest, release the button to stop.



Rocking

Short press to turn on/off rocking function.



Zero Gravity

Press this button to toggle among zero gravity 1, zero gravity 2, zero gravity 3.



Massage Intensity

Press this button to toggle among five massage intensities.



Airbag Intensity

Press this button to toggle among five air intensities.

06 How to Use



Heating

Press this button to turn on/off back heat.



Roller Speed

Press this button to toggle among six roller speeds.



Airbag Mode

Under foot program, press this button to toggle among three air pressure modes: kneading massage, pulse massage, alternating massage.



Pause/play

Press this button to stop during the massage, press again to restart the massage.



Timer

Press this button to toggle among 10mins, 15mins, 20mins, 25mins, 30 mins.



Child Lock

Long press this button for turning on or turning off the child-lock function.



Caution

- * Before getting in the chair, please make sure the backrest is restored to upright position, you may recline the chair to desired angles after sitting in the chair.
- * Do not get into the massage chair when the footrest is lifted. a sudden excessive load pressed on the backrest or footrest may cause damage to the product or injury to the user.
- * Do not put foot, fingers or any other objects in the openings of the chair.
- * Make sure there are no children, pets or other obstacles around before adjusting the backrest or footrest angle.