

# Installation & Assembly

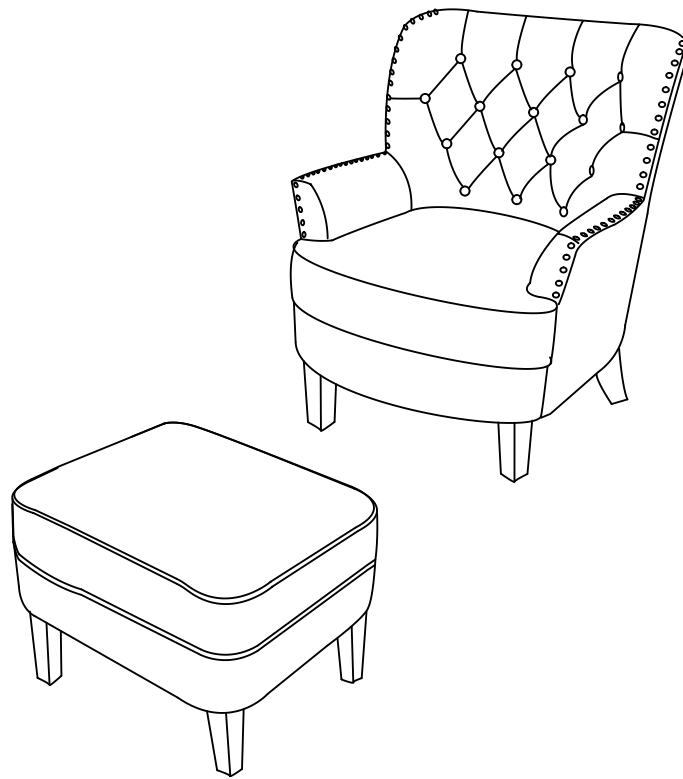

## Quality statement

Alton appreciates your selection of our product. Through our detailed quality checks, we ensure that each box contains exceptional components that will exceed your expectations.

## Customer Service

If your order has missing parts or defective items or if you have any questions, please do not hesitate to contact our customer service department

## Care Instructions

Please follow the instructions provided below for proper care of your product. Following these tips will ensure your furniture's high-standard quality remains as it ages

- Vacuum regularly to eliminate dust as they can be abrasive and wear the furniture prematurely
- Never use harsh chemicals or solvents as this may damage the finish
- Limit contact with liquids as this may damage the finish
- Bolt spills immediately to prevent staining. If necessary, gently wipe using a clean cloth dampened with warm water. Proceed to brush lightly after drying
- If you choose to use a professional product, test the fabric in a discreet area for any signs of defect
- Stains from markers, pens, crayons, and pens may be difficult to remove. We recommend that you consult a professional



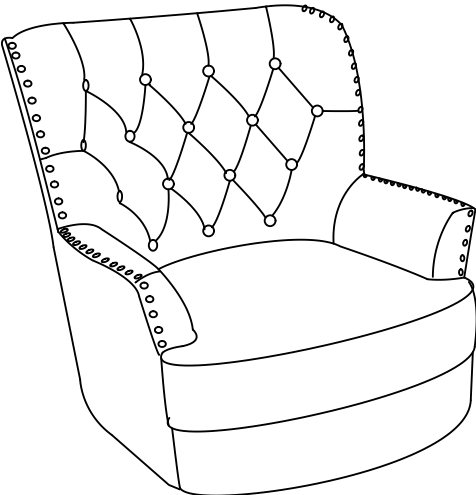
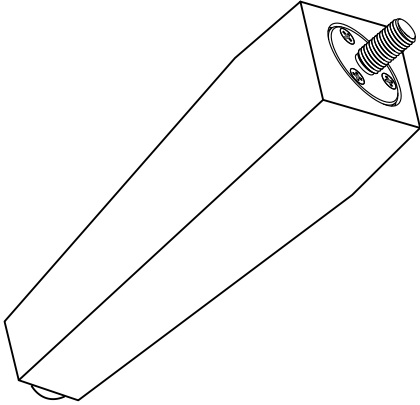
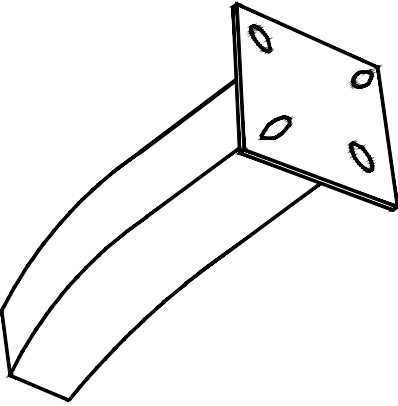
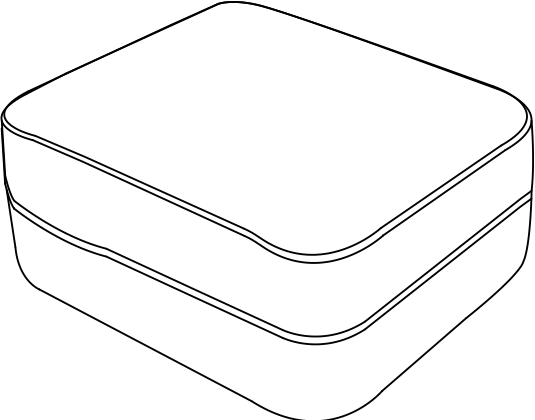

# PARTS LIST

PLEASE CHECK TO ENSURE ALL PARTS ARE IN THE BOX

A	1PC	B	6PCS
Chair Body		Ottoman & Chair Front Legs	
			
C	2PCS	D	1PC
Back Legs		Ottoman	
			

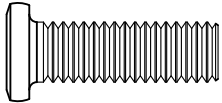
# HARDWARE LIST

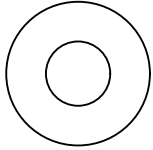
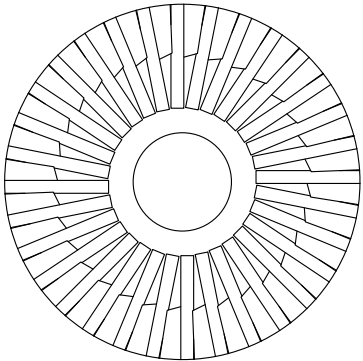
PLEASE CHECK TO ENSURE ALL PARTS ARE IN THE BOX

①	8PCS	②	8PCS	③	8PCS
Allen Bolts 5/16" x 1"		Spring Washers		Flat Washers	
					
④	6PCS		⑤	1PC	
Washers			Allen Wrench		
					

1)

Attach the Front Legs (B) to the bottom of Chair Body (A) by using Washers (4).

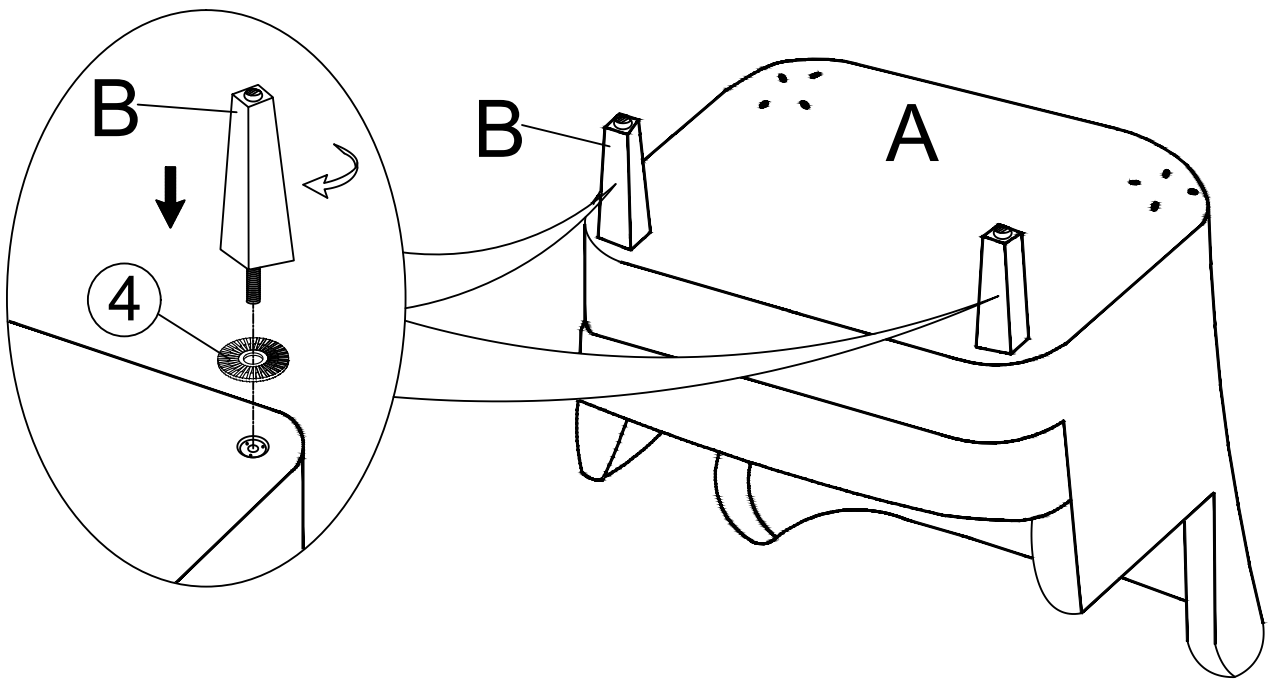

2)

Assemble the back legs(C) to the bottom of chair body(A) by using flat washers (3), spring washers(2)and bolts(1). Fully tighten all bolts.

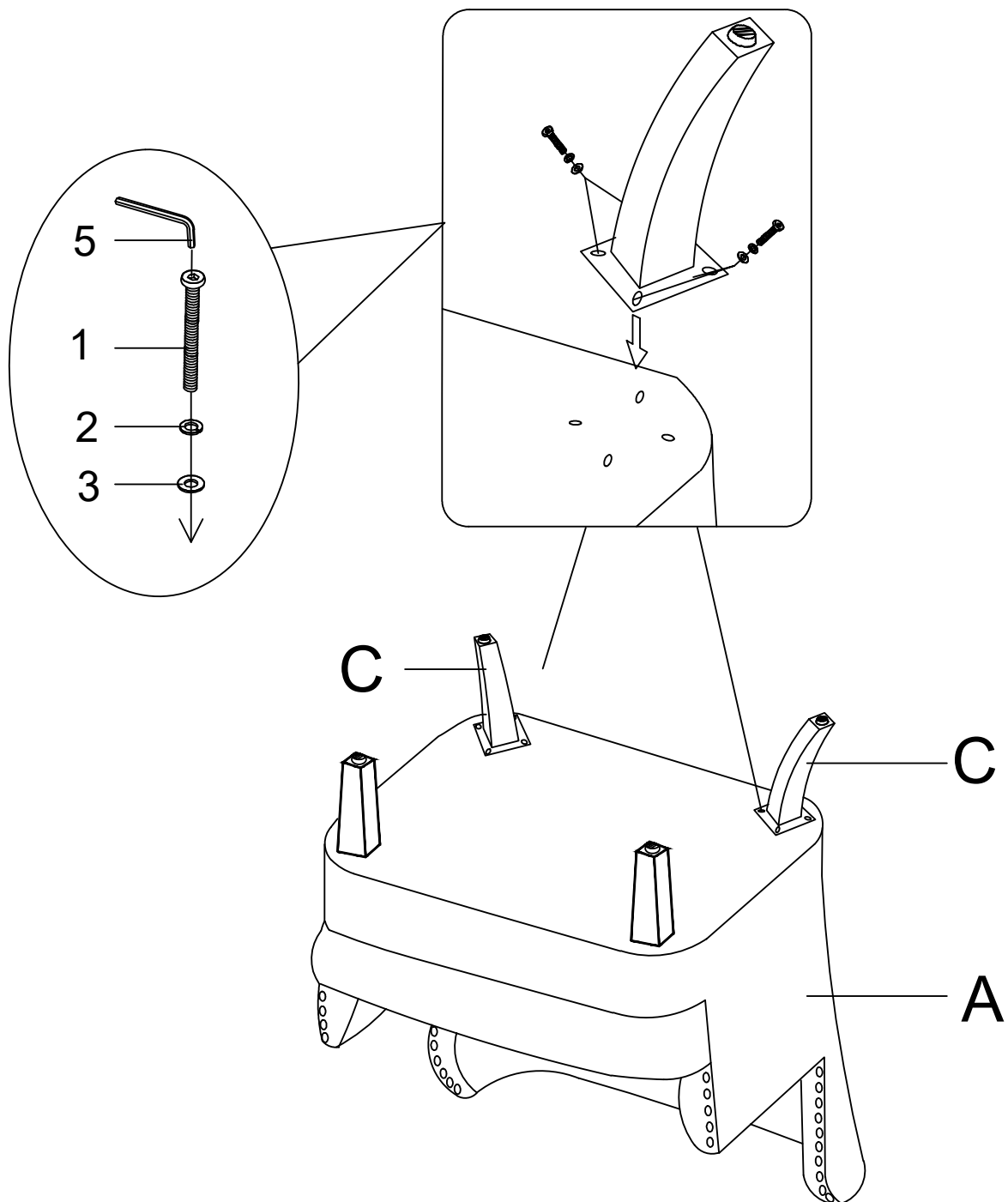

3)

Attach the Legs (B) to the bottom of Ottoman (D) by using Washers (4).

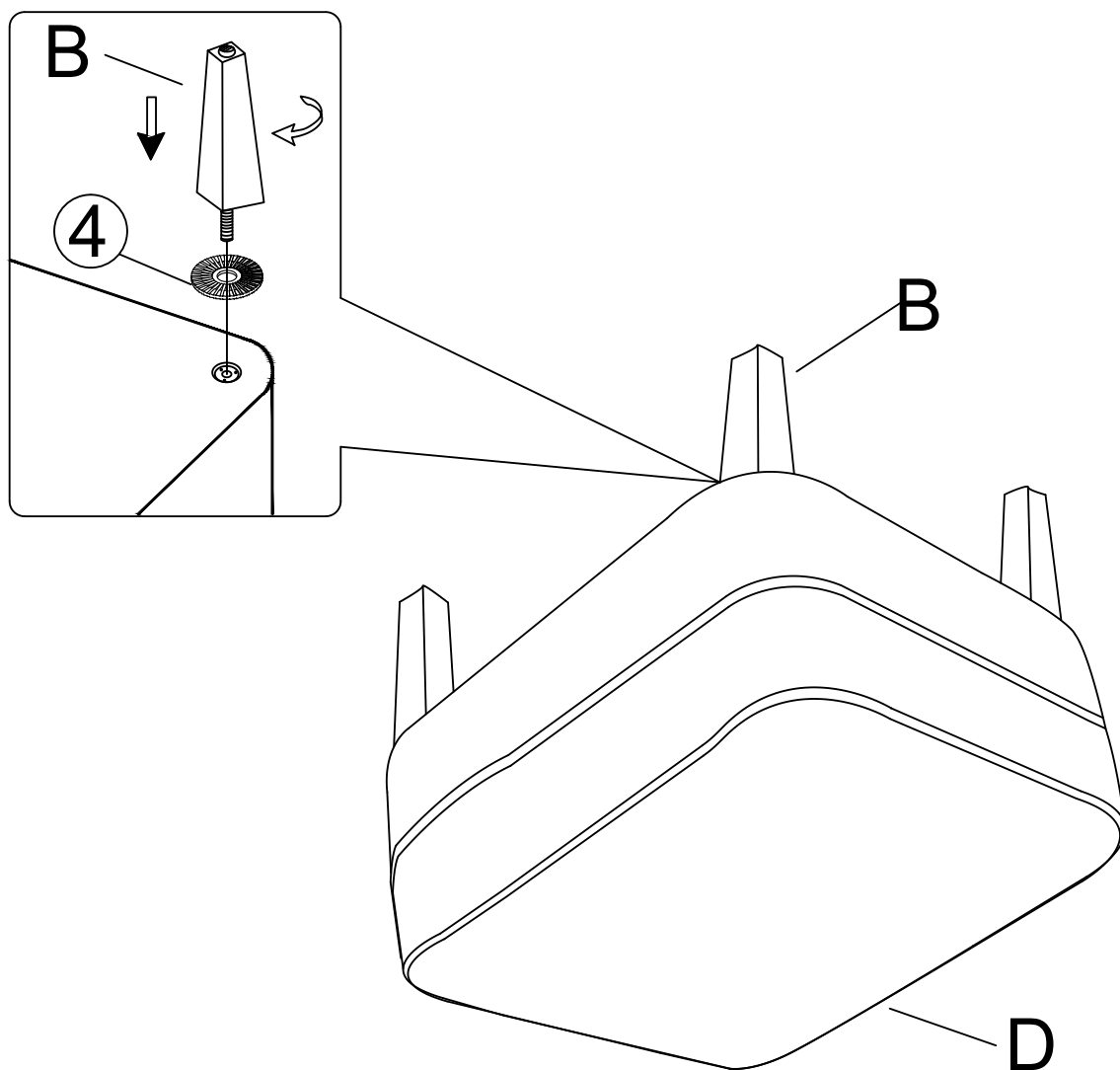

There are adjustable levelers underneath each leg, please evenly adjust the chair.

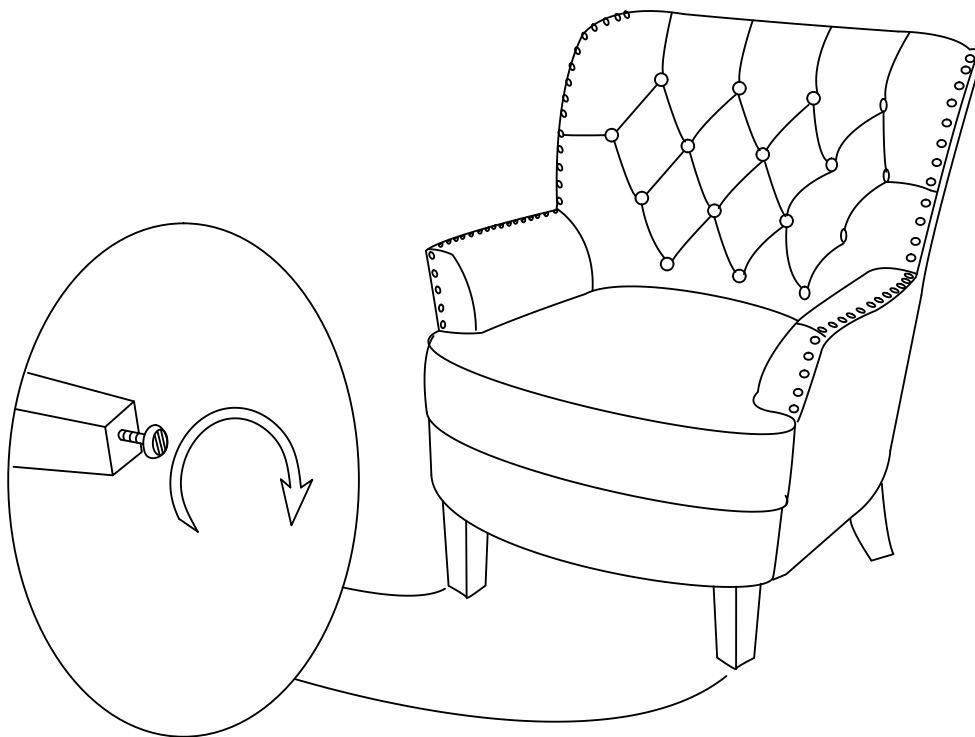

There are adjustable levelers underneath each leg, please evenly adjust the ottoman.

