

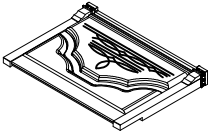

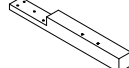

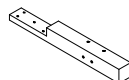
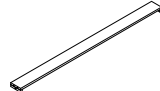

Thank you for purchasing this quality product. Be sure to check all packing material carefully for small parts, which may have come loose inside the carton during shipment. Identify and count all parts and compare with the **HARDWARE LIST** below.

**HARDWARE/ PART LOCATION**

B0 2122 6H - KING HEADBOARD > Step 1 & 2 hardware > Inside red pack with red tape > Placed at the left corner of headboard  
> Headboard legs & stretcher > Inside labeled inner carton > Placed at the below headboard

NO.	PARTS LIST		Q'TY
A		Headboard	1
B		Headboard leg (left)	1
C		Headboard leg (right)	1
D		Bottom stretcher	1

NO.	HARDWARE LIST		Q'TY
1		Wood dowel Ø8*30mm	4
2		Flat Washer Ø5/16*19mm	12
3		Spring Washer Ø5/16	12
4		Bolt Ø5/16*55mm	12
5		Allen key #M4	1

**TOOL REQUIRED (NOT PROVIDED)**



Phillips Screw Driver

**STEP 1**

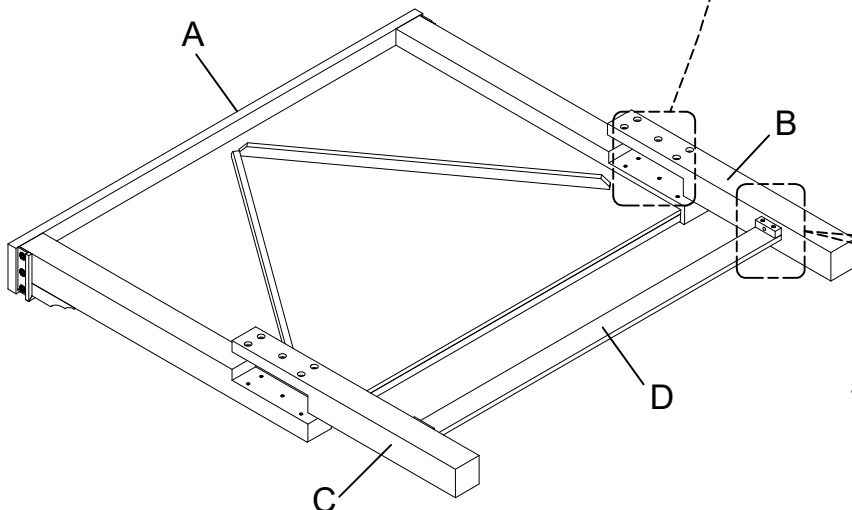
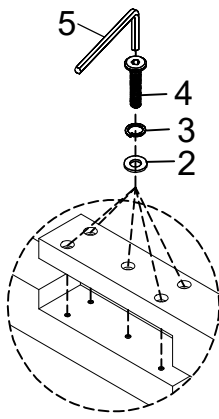

**STEP 2**

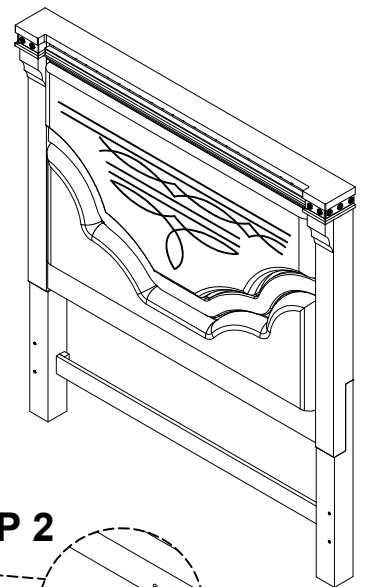
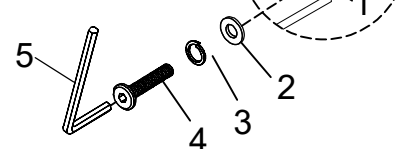

Assembly completed







# ASSEMBLY INSTRUCTIONS







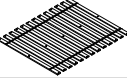

ITEM NO: B02122 6H KING HEADBOARD  
 B02122 6BSF KING BENCH STORAGE FOOTBOARD  
 B02122 56SR QUEEN /KING STORAGE RAILS

Thank you for purchasing this quality product. Be sure to check all packing material carefully for small parts, which may have come loose inside the carton during shipment. Identify and count all parts and compare with the **HARDWARE LIST** below.

### HARDWARE/ PART LOCATION

B02122 6BSF - KING BENCH STORAGE FOOTBOARD > Step 1 & 4 hardware > Inside red pack with red tape > Placed next to the leg box  
 > Support leg for the footboard and slat > Inside labeled inner carton  
 > Placed above the slat  
 B02122 56SR - QUEEN /KING RAILS > Step 2 hardware > Inside red pack with red tape > Placed below the side rails

NO.	PARTS LIST	Q'TY
A	 Headboard	1
B	 Side rails	2
C	 Footboard	1
D	 Support leg for footboard	3
E	 Slat roll	1
F	 Support leg for slat	4

NO.	HARDWARE LIST	Q'TY
1	 Flat Washer Ø1/4*19mm	6
2	 Spring Washer Ø1/4	6
3	 Bolt Ø1/4*35mm	6
4	 Allen wrench #M4	1
5	 Bolt Ø5/16*110mm	8
6	 Curved washer Ø5/16*25*16mm	8
7	 Double hex nut Ø5/16*12mm	8
8	 Open wrench Ø12	1
9	 Screw #4*25mm	26

### TOOL REQUIRED (NOT PROVIDED)

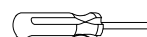

Phillips Screw Driver

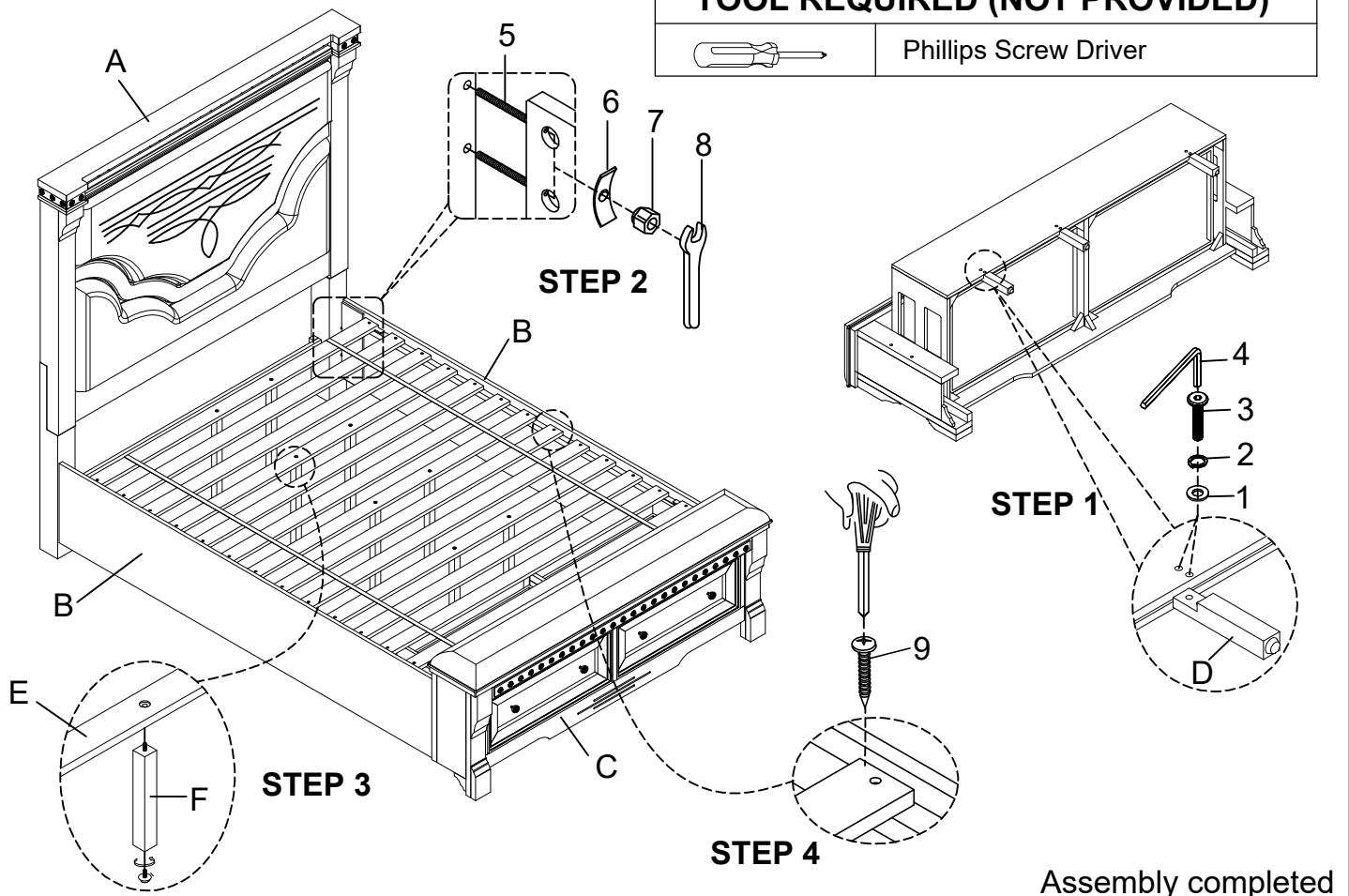













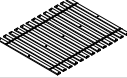

ITEM NO: B02122 6H KING HEADBOARD  
 B02122 6BSF KING BENCH STORAGE FOOTBOARD  
 B02122 7SR CAL KING STORAGE RAILS

Thank you for purchasing this quality product. Be sure to check all packing material carefully for small parts, which may have come loose inside the carton during shipment. Identify and count all parts and compare with the **HARDWARE LIST** below.

### HARDWARE/ PART LOCATION

B02122 6BSF - KING BENCH STORAGE FOOTBOARD > Step 1 & 4 hardware > Inside red pack with red tape > Placed next to the leg box  
 > Support leg for the footboard and slat > Inside labeled inner carton  
 > Placed above the slat  
 B02122 7SR - CAL KING RAILS > Step 2 hardware > Inside red pack with red tape > Placed below the side rails

NO.	PARTS LIST	Q'TY
A	 Headboard	1
B	 Side rails	2
C	 Footboard	1
D	 Support leg for footboard	3
E	 Slat roll	1
F	 Support leg for slat	4

NO.	HARDWARE LIST	Q'TY
1	 Flat Washer Ø1/4*19mm	6
2	 Spring Washer Ø1/4	6
3	 Bolt Ø1/4*35mm	6
4	 Allen wrench #M4	1
5	 Bolt Ø5/16*110mm	8
6	 Curved washer Ø5/16*25*16mm	8
7	 Double hex nut Ø5/16*12mm	8
8	 Open wrench Ø12	1
9	 Screw #4*25mm	26

### TOOL REQUIRED (NOT PROVIDED)

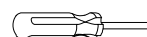

Phillips Screw Driver

