

ASSEMBLY INSTRUCTIONS





Upholstered Tufted Mid century Bench

Thank you for purchasing this quality product. Be sure to check all packing material carefully for small parts, which may have come loose inside the carton during shipment.

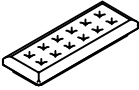
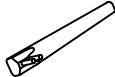
Caution : Please read instructions thoroughly before unpacking assembly parts. Sharp, exposed staple tips can cause injury, therefore, for your protection, please remove any exposed staples used in packing. *please keep all hardware parts out of the reach of children.*

1. We recommend that you should assemble this product with the assistance of another person; this will make assembly easier, and will help to eliminate damage to the product or injury to persons during assembly.
2. Be sure to check all packing materials carefully for small parts that may have come loose inside the carton during shipment.
3. Please do not over tighten screws or bolts.
4. Please put all parts on a non-abrasive floor before assembly, and follow the assembly steps to assemble your newly purchased product correctly and efficiently.

NO.	PARTS LIST	Q' TY
A	 Top Table	1
B	 Legs	4

NO.	HARDWARE LIST	Q' TY
1	 $\Phi 5/16"$ x $\Phi 19$ x 2mmT Flat Washer	8
2	 $\Phi 5/16"$ x $\Phi 13$ Spring washer	8
3	 $\Phi 5/16"$ x 10mm Nut	8
4	 $\Phi 5/16"$ x 13 Wrench	1

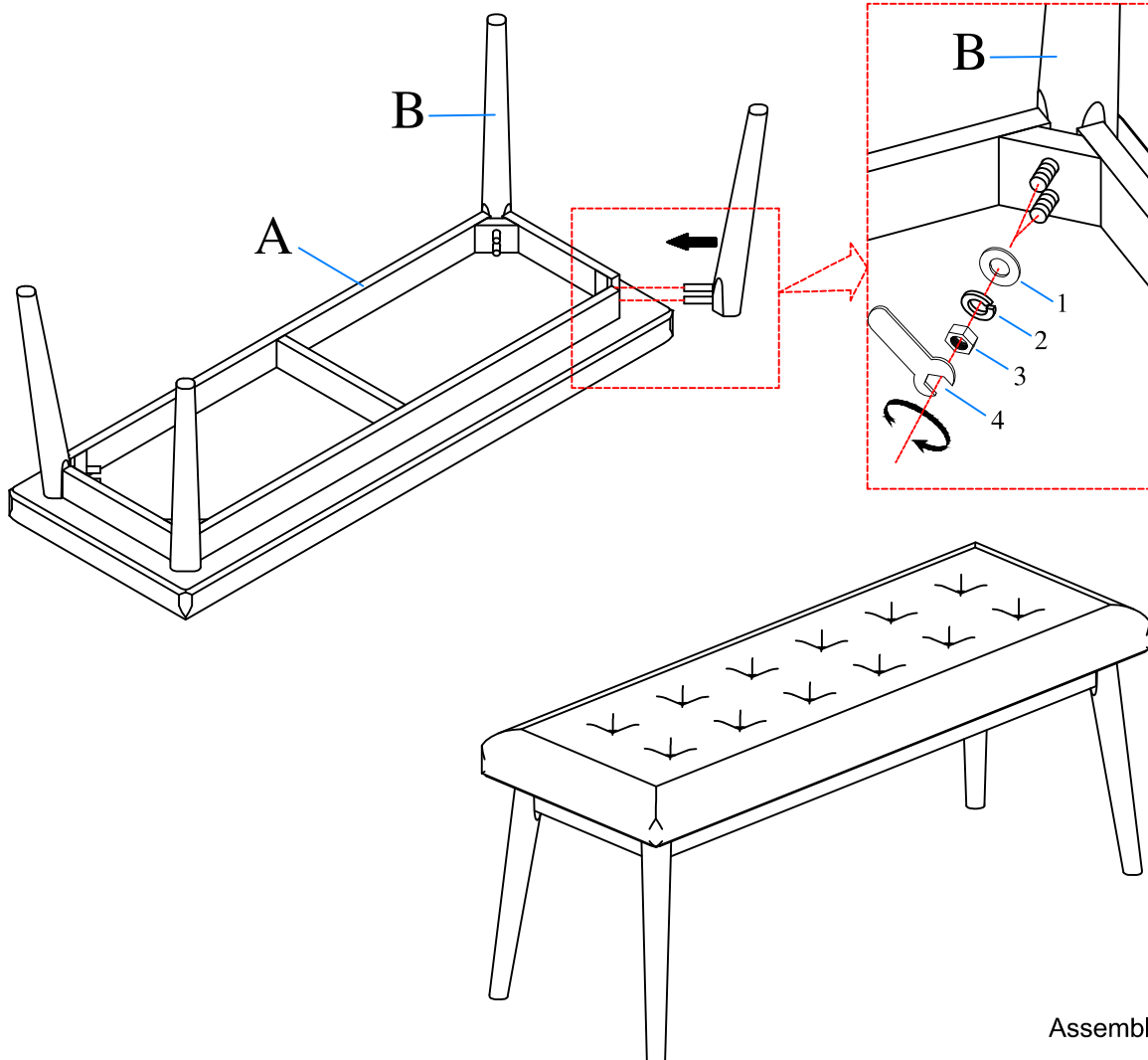

Assembly completed