





Thank you for purchasing this product. This product has been manufactured with the highest standards of safety and quality.

PLEASE READ ALL INSTRUCTIONS BEFORE ASSEMBLY.



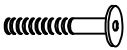

Unpack all parts from the packaging inside the carton to ensure there are no missing or damaged parts. Do not attempt to assemble or use the product if any parts are missing or damaged.

CARTON CONTENTS:

Hardware - For Headboard

A. x 4	B. x 4	C. x 4	D. x 4
 M8 x 40			

Hardware - For Metal Bed Frame Connection

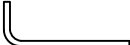
E. x 4	F. x 4	G. x 8	H. x 4	I. x 4	J. x 1
 M6 x 60	 M6 x 35				

Panels -

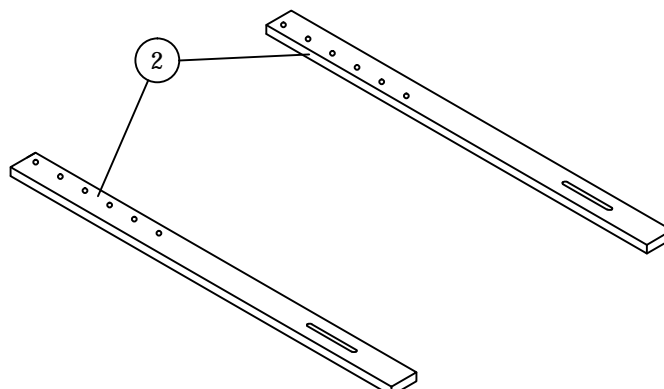
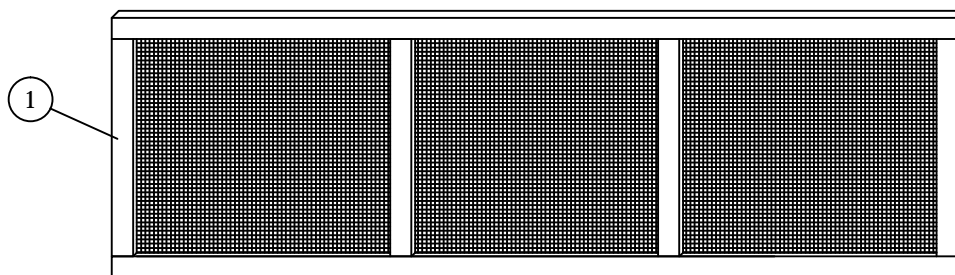

Tools required for assembly: Philips screwdriver and flathead screwdriver (if using power tools, use with care).



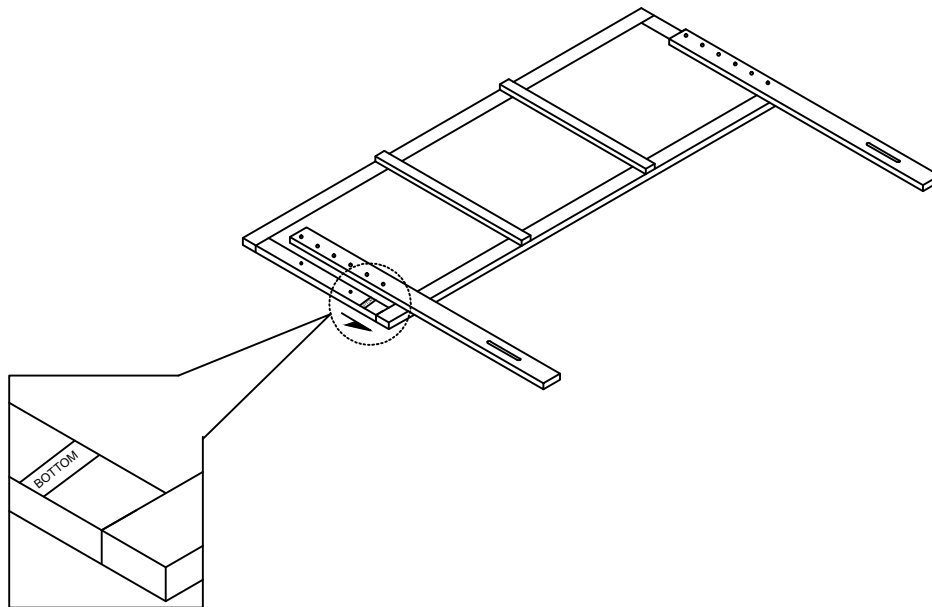

ASSEMBLY INSTRUCTIONS:

Step 1: Align pre-drilled support stand holes over the pre-drilled headboard holes according to your desired headboard height.

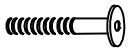

Note: Make sure the sticker
"BOTTOM" faced to Down

Step 2: Secure each support stand by using 2pcs JCBB Bolt [A] , 2pcs M8 Flat Washer [B] and 2pcs M8 Spring Washer [C] , Tighten with supplied Allen Key [D]. Repeat the same procedure to secure the other side.

A. x 4	B. x 4	C. x 4	D. x 1
 M8 x 40			

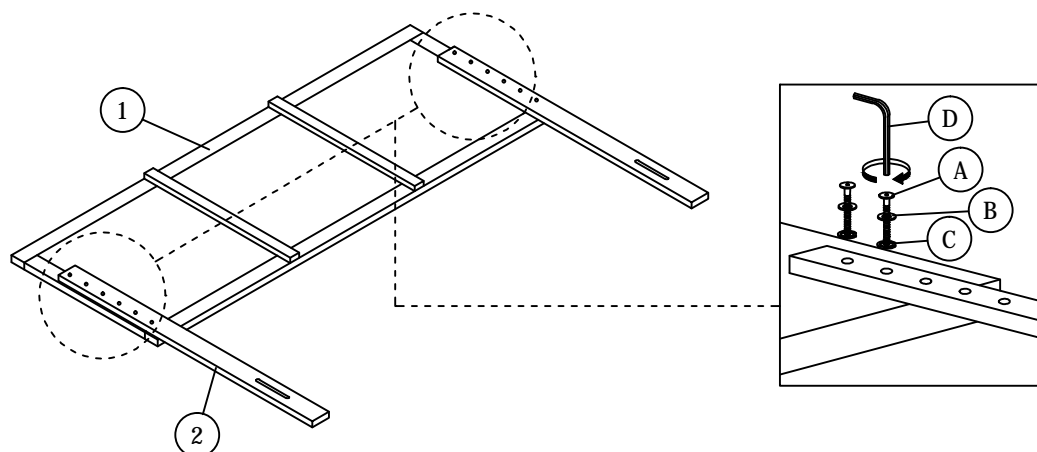

Instruction Manual

Please save this manual for future reference.

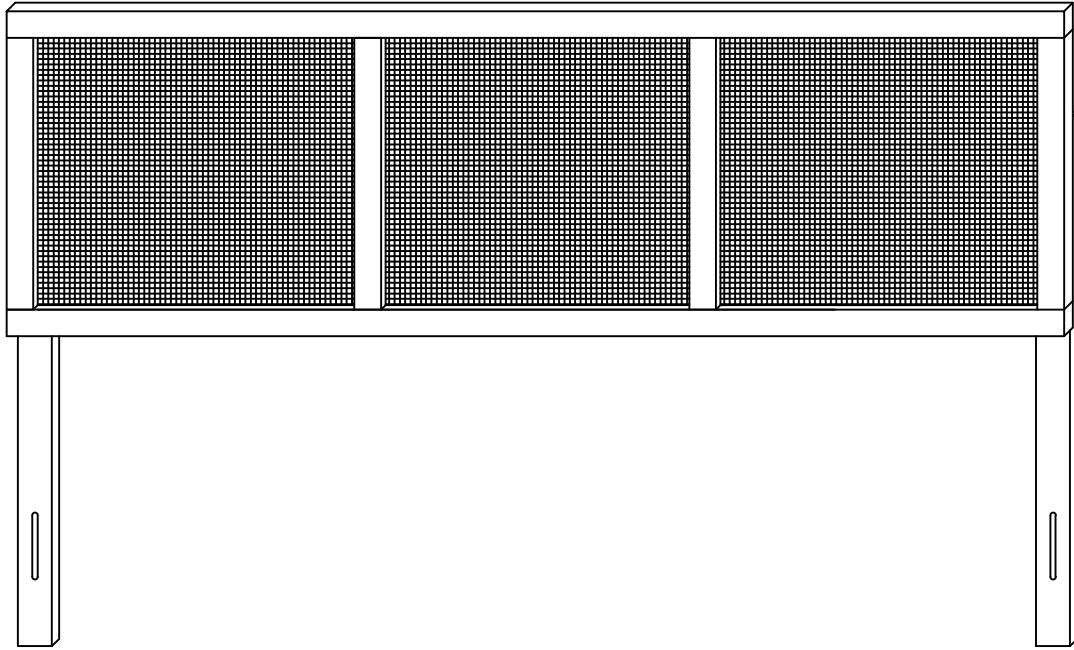







Your headboard assembly is complete.

Note: Hardware may loosen over time. Periodically check that all connections are tight.

ASSEMBLY INSTRUCTIONS FOR METAL BED FRAME :

Note: Extra screws were provided for attaching the headboard to your bed frame (use is optional).

1. Line up the bed frame board's pre-drilled holes to match those of the headboard. (Bed frame not included.)
2. Secure the headboard to the bed frame by using 2pcs JCBB bolt 60mm (E) for the thicker bed frame, and 2pcs JCBB bolt 35mm (F) for the thinner bed frame. Before inserting each bolt, place a M6 spring washer (H) and M6 flat washer (G) on each bolt. Then fit a M6 flat washer (G) on the screw as it protrudes through the other side of the bed frame.
3. Place a M6 Hex Nut (I) after the M6 flat washer (G) at the end of each screw. Then tighten by using the M4 Allen key (J).
- 4) Repeat the same procedure for each screw and each side of the bed frame.

E. x 4	F. x 4	G. x 8	H. x 4	I. x 4	J. x 1
					
M6 x 60	M6 x 35				

