

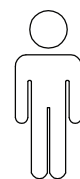



15'

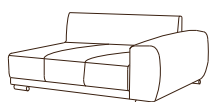
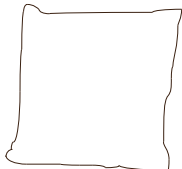

2

A	B	C	D	E
				
x 1	x 1	x 4	x 4	x 4

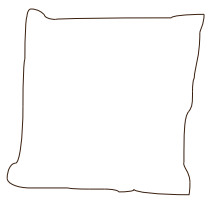

C x 4



E x 4

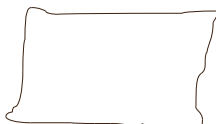

D x 4

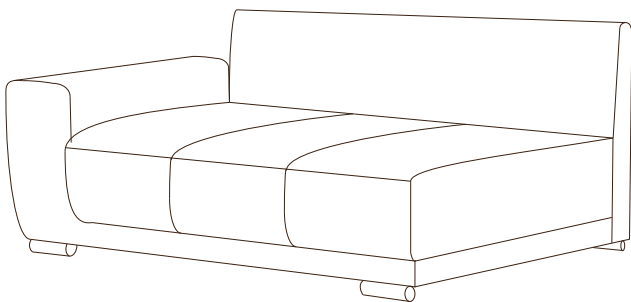

A

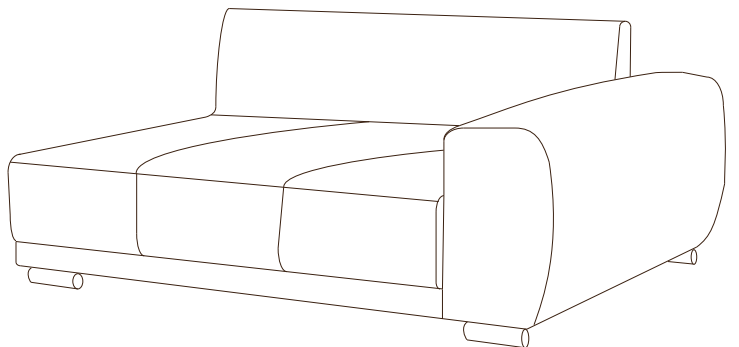

B

1

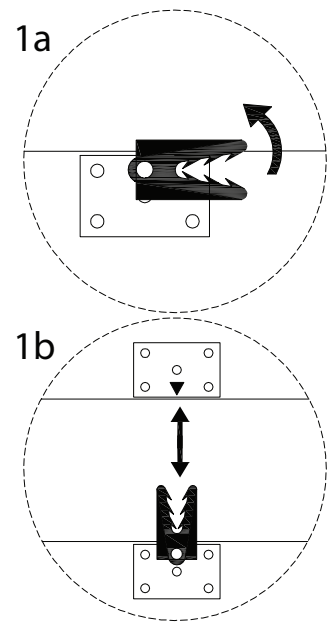
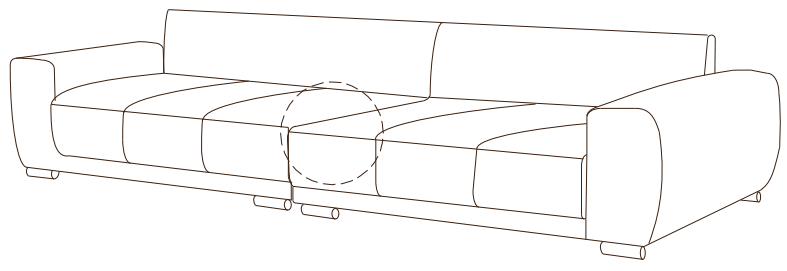
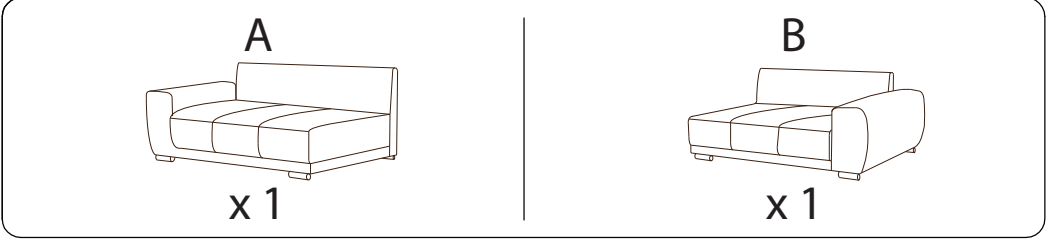

2

