

| | |
|-----|-----|
| A1 | 1PC |
| A2 | 1PC |
| A3 | 4PC |
| A4 | 4PC |
| A5 | 1PC |
| A6 | 1PC |
| A7 | 1PC |
| A8 | 1PC |
| A9 | 1PC |
| A10 | 1PC |
| A11 | 1PC |

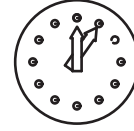

5 min

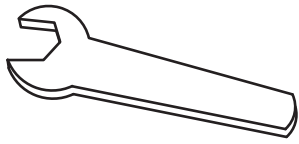
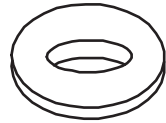

$\phi 8 \times \phi 16$ 4*A4

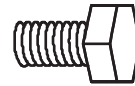

M8x16mm 4*A3

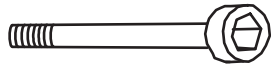

M6x38 1*A10

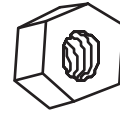

M6 1*A11

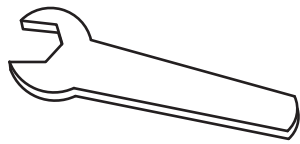

M8 1*B1

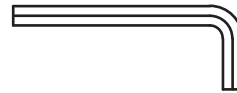

M6 1*B2

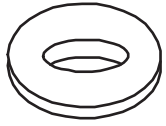

$\phi 8 \times \phi 16$ 4*A4

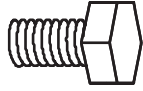

M8x16mm 4*A3

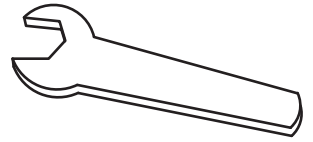

M8

1*B1

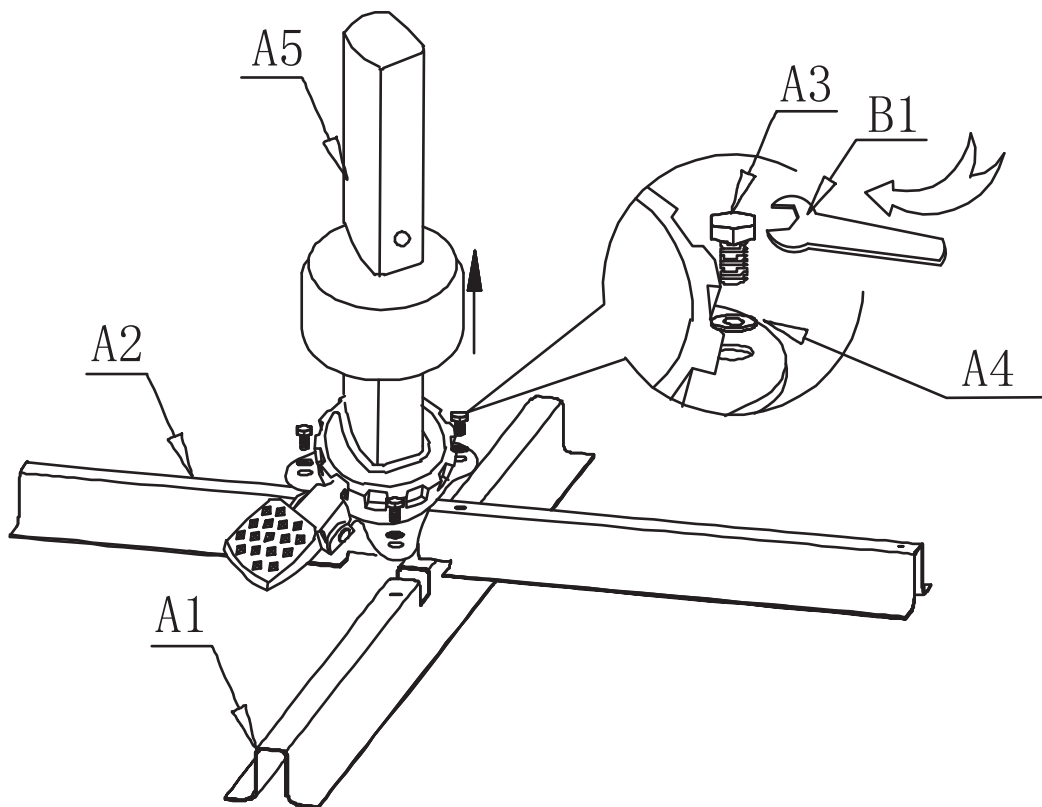



M6x38

1*A10



M6

1*A11

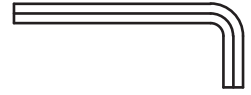

M6

1*B2

