

CARE AND MAINTENANCE

Spot clean using a mild water-free solvent. Only a professional cleaner should undertake a complete overall cleaning.

The use of steam or water-based cleaners may cause excessive shrinking or staining.

NOTICE

- * Prior to assembly, ensure that all parts are accounted for.
- * This item should be assembled on a soft surface to prevent scratching the finish during assembly.
- * This item may require periodic tightening.
- * Do not overtighten bolts.

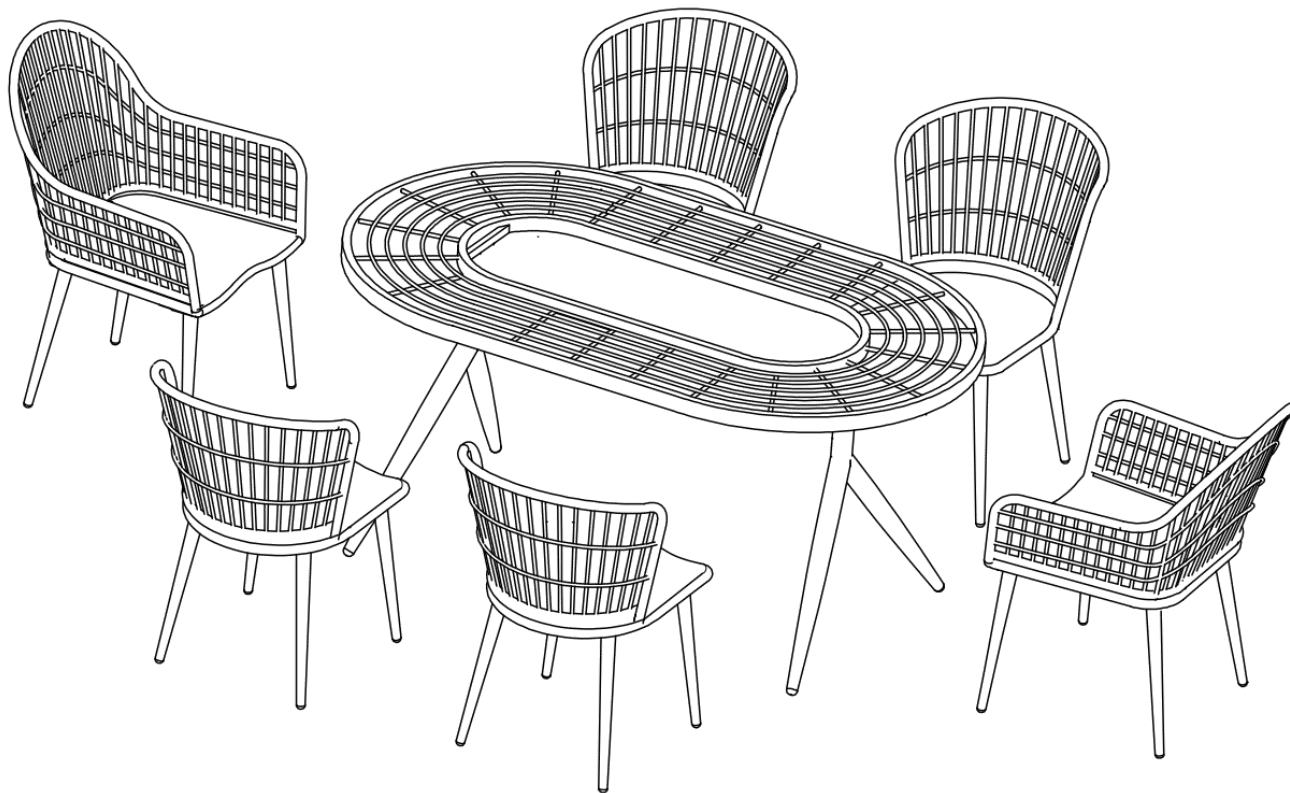

Item Dimension

Armchair: W22.2"*D23.6"*34.3"

Armless Chair: W21.1"*D23.6"*H32.3"

Dining Table: W62.8"*D37.2"*H29.1"

Weight Capacities

1SEATER:220LBS

TABLE:110LBS

PREPARATION

Before beginning assembly of product, make sure all parts are present. Compare parts with package contents list and hardware contents list. If any part is missing or damaged, do not attempt to assemble the product.







Estimated Assembly Time: 45 minutes.

Tools Required for Assembly (included): Allen Key

Gradually tighten bolts in a star pattern: tighten one bolt and then the one opposite from it until all bolts are tightened.

Chair Assemble

Part List And Hardware List

PIECE	DESCRIPTION	PICTURE	QUANTITY
A	Chair		4
B	Front Chair leg		8
C	Rear leg		8
D	Cushion		4
HW1	Bolt and washer M6*15		48
HW2	Allenkey		1

STEP 1

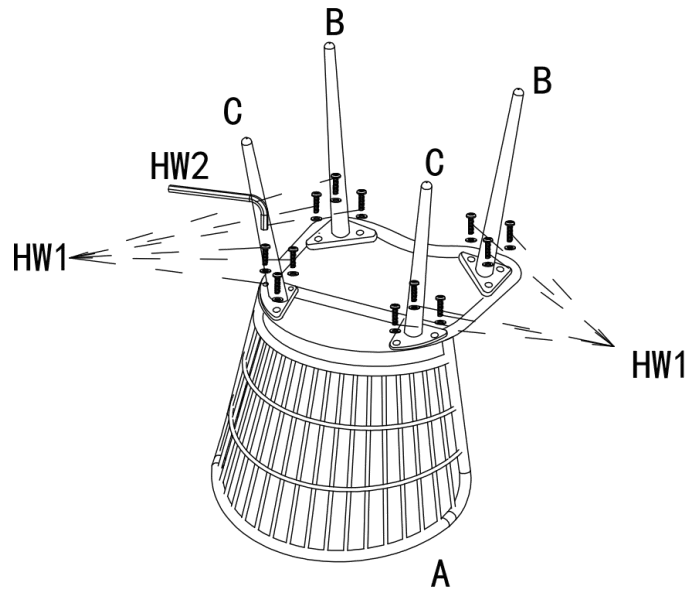

STEP 2

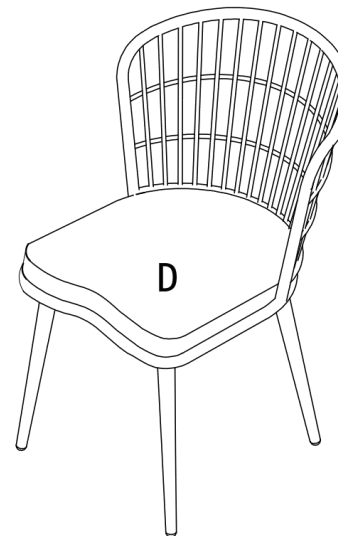

PREPARATION

Before beginning assembly of product, make sure all parts are present. Compare parts with package contents list and hardware contents list. If any part is missing or damaged, do not attempt to assemble the product.

Estimated Assembly Time: 45 minutes.

Tools Required for Assembly (included): Allen Key

Gradually tighten bolts in a star pattern: tighten one bolt and then the one opposite from it until all bolts are tightened.

Chair Assemble



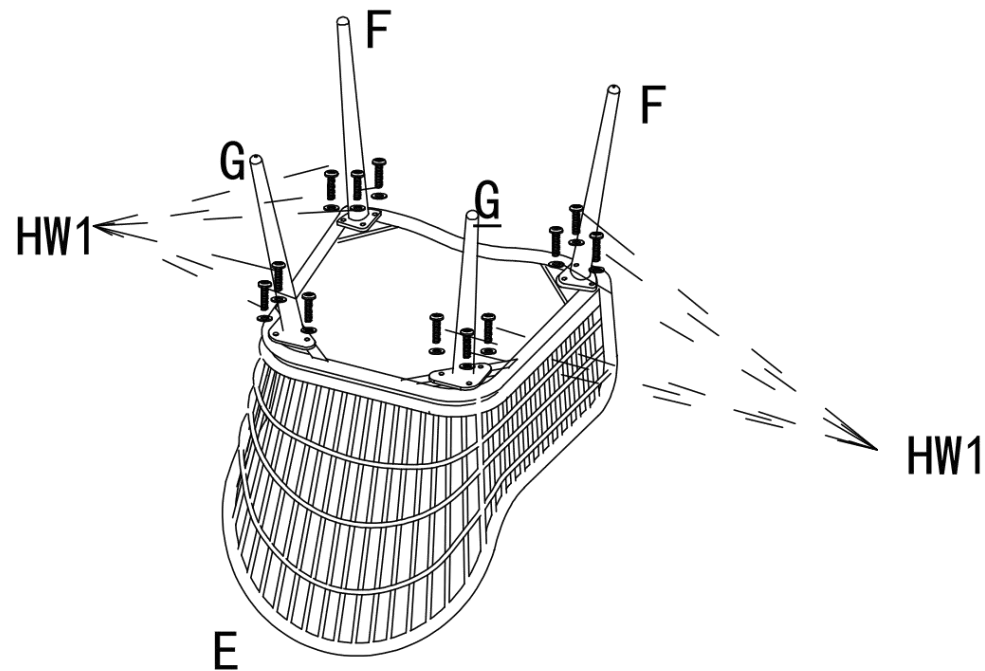

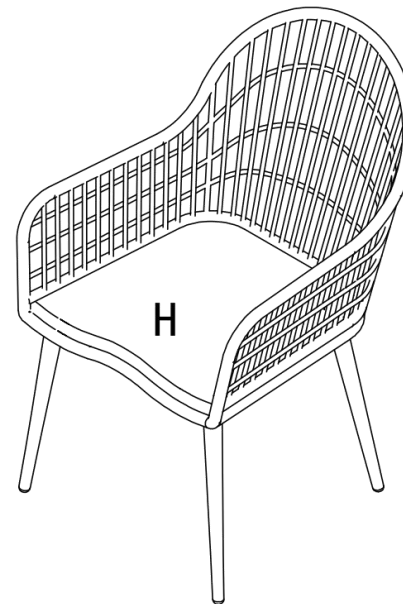

STEP 1



STEP 2

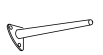

Part List And Hardware List

PIECE	DESCRIPTION	PICTURE	QUANTITY
E	Chair		2
F	Front leg		4
G	Rear leg		4
H	Cushion		2
HW1	Bolt and washer M6*15		24
HW2	Allenkey		1

PREPARATION

Before beginning assembly of product, make sure all parts are present. Compare parts with package contents list and hardware contents list. If any part is missing or damaged, do not attempt to assemble the product.

Estimated Assembly Time: 60 minutes.

Tools Required for Assembly (included): Allen Key

Gradually tighten bolts in a star pattern: tighten one bolt and then the one opposite from it until all bolts are tightened.

Table Assemble



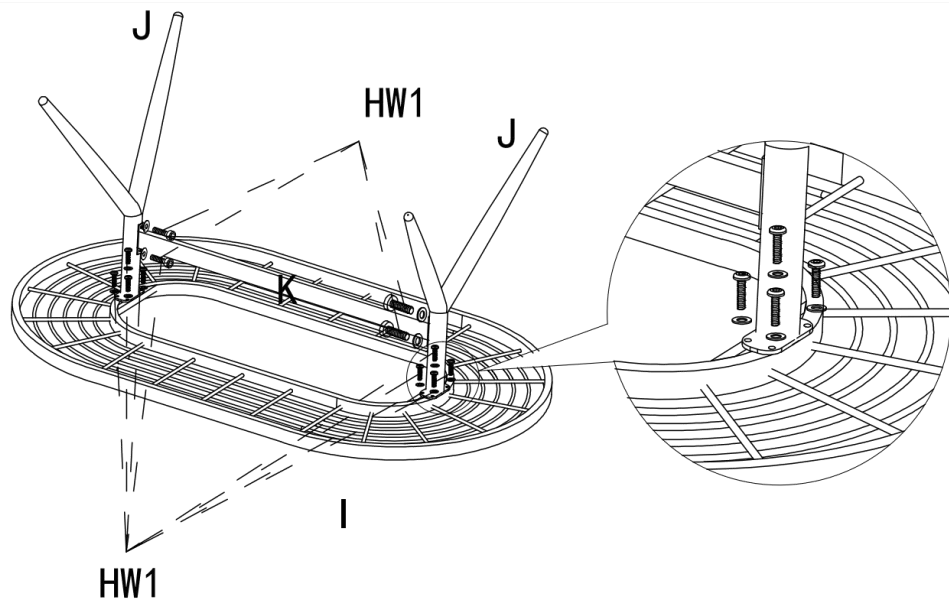

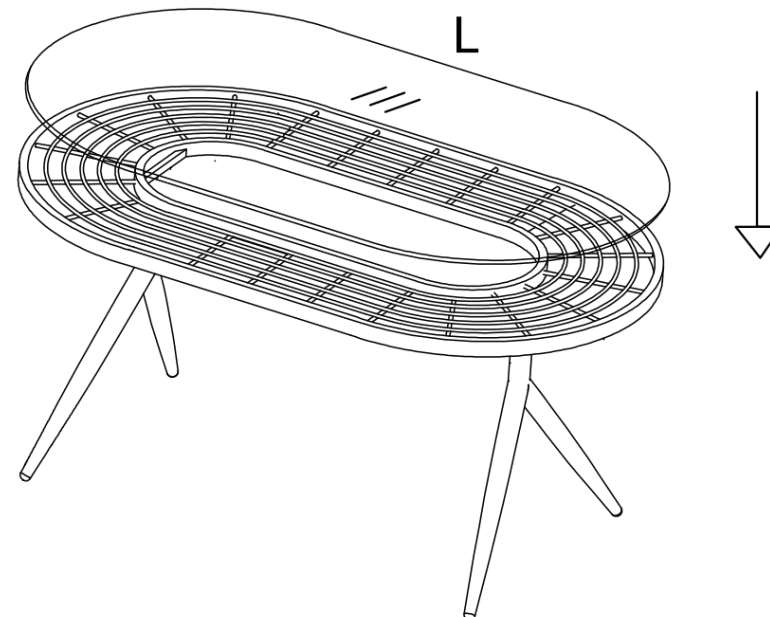

STEP 1



STEP 2



Part List And Hardware List

PIECE	DESCRIPTION	PICTURE	QUANTITY
I	Table top		1
J	leg		2
K			1
L	Glass		1
HW1	Bolt and washer M6*15		12
HW2	Allenkey		1