

INSTRUCTION MANUAL

Sectional Cloud Couch with Storage

MODEL:FSO002

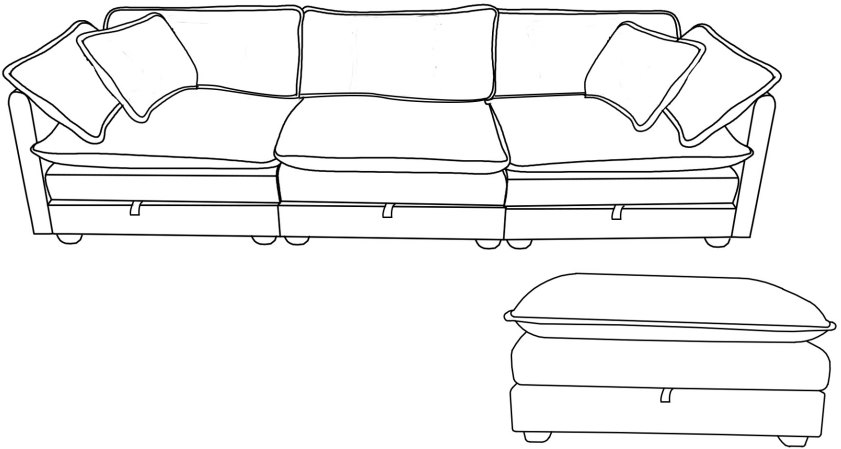

Note:

1. Please confirm all parts are correct before you assemble
2. This product is shipped in 2-4 boxes (Depending on the seat number you choose), if you only receive one box first, don't worry, other boxes are on the way.
3. Do not tighten fastening fully until assembly is complete
4. DO NOT USE POWER TOOLS. Power tools can overtighten screws.

If you have any questions, please feel free to contact us:

Email: sofabedservice@163.com

FAQ:

Q1:Missing parts when received.

A1: If you find some parts are missing from the box, please kindly send us messages to let us know the name of missing parts according to the parts list of the instruction, we will send you the replacement asap.

Q2: Difficult to assemble

A2:It is best for two people to install the sofa. If there are any problems during the installation process, you can take photos and send them to us, and we will reply promptly. There are also installation videos on our Amazon page that you can view online.

Q3: Some parts were damaged when arrived.

A3: Please send us the clear photo of the damaged part as an attachment, we will check it and offer you the best solution soon.

Q4:Only received one or two boxes.

A4: We normally ship all boxes on the same day, but the boxes may not be delivered together because of the carrier. The delivery time interval between the packages will not normally exceed three days. And you can also contact the seller and ask for the delivery time of the other boxes.

Q5:Want to return the product.

A5: Before returning the item, please contact us regarding the return issue. Please make sure that the box packaging is complete, the product is not damaged, stained, and does not affect secondary sales. Products returned without the original packaging may be rejected, and we may request pictures to be provided.

Many Different Sectional

4Seats(A+B)

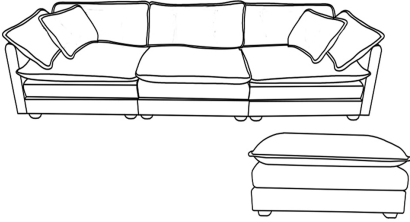

5Seats(A+B+D)

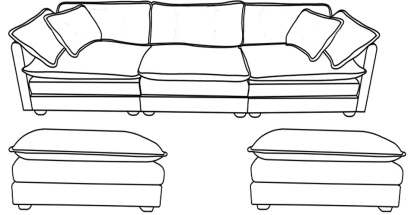

6Seats(B+B+C)

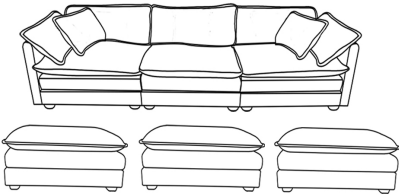

6Seats(A+B+C)

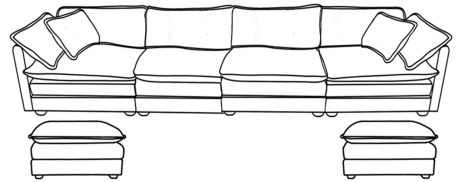

8Seats(B+B+C+C)

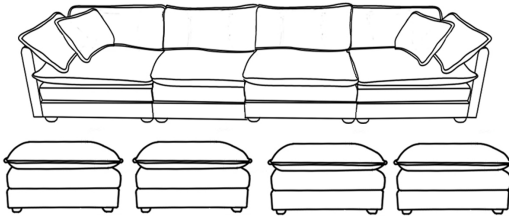

Quick Start:

1. Find your variant & check boxes. Different variants ship with different boxes. Before assembly, confirm you've received all boxes. If any box or part is missing or damaged, please contact us by email or through the platform and we'll help right away.

Variant	Expected boxes	Total
4 Seat Sleeper	A+B	2
5 Seat Sleeper	A+B+D	3
6 Seat Sleeper	B+B+C	3
6 Seat Sleeper	A+B+C	3
8 Seat Sleeper	B+B+C+C	4

Box	Name
A	Center and End Module
B	End and Ottoman Module
C	Center and Ottoman Module
D	Ottoman





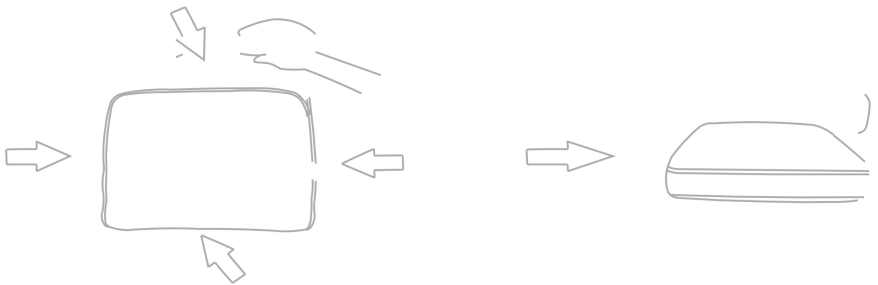

2. Color may vary slightly. Due to lighting and display differences, the actual material color may differ slightly from the photos.

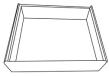
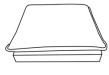
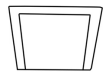

3. Vacuum-packed cushions. To reduce shipping volume, cushions are vacuum-packed. After unsealing, gently pat and fluff each cushion and allow 24–72 hours to fully recover to the look shown in the images.

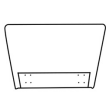

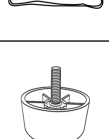
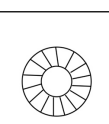
- ①. Pat to make it rebound better and fluffy.
- ②. Knead your cushion like giving your cushion a massage while allowing the air to flow through the foam.

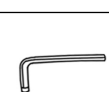
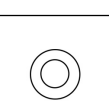
BOX A:

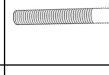
A	Seat frame		2PCS
B	Seat cushion		2PCS
C	Back frame		2PCS
D	Storage box lid		2PCS
E	Armrest		1PC
F	Back cushion		2PCS
H	Arm pillow		1PC
I	Leg		8PCS
J	Gasket		8+1PCS
N	Spanner		1PC
O	Allen Key		1PC
P	Flat Washer		24+1PCS

Q	Nut		6+1PCS
R	Bolt M8		6+1PCS M8*65
S	Bolt M8		12+1PCS M8*50
T	Felt pad		8+1PCS

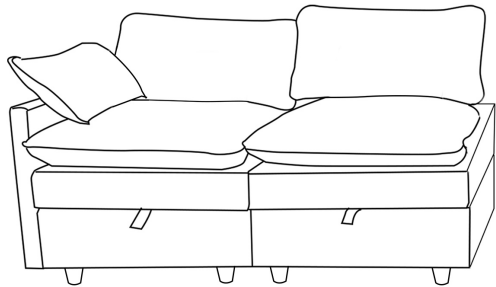

BOX A:

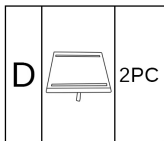



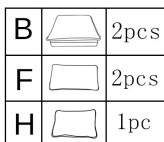
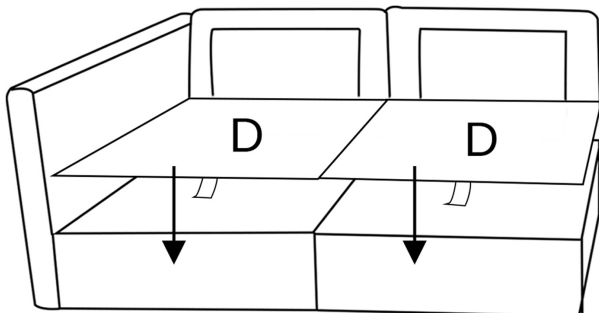

STEP5 Place the sofa storage lid

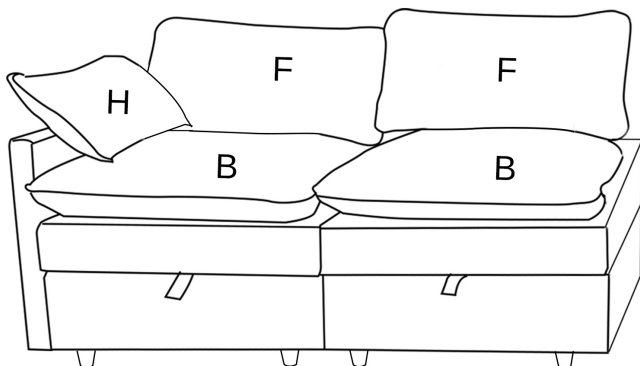
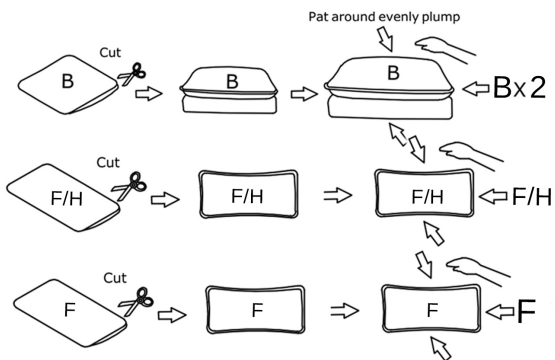

STEP6 Open the vacuum-sealed packages and pat them for rebound.





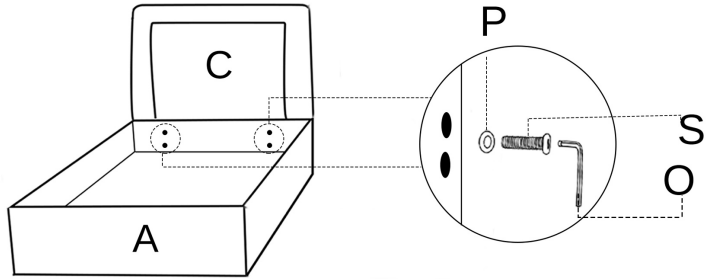

BOX A:

A		1pc
C		1pc
P		4pcs
S		4pcs
O		1pc



STEP1 Assemble the backrest



E		1pc
P		4pcs
S		4pcs
O		1pc

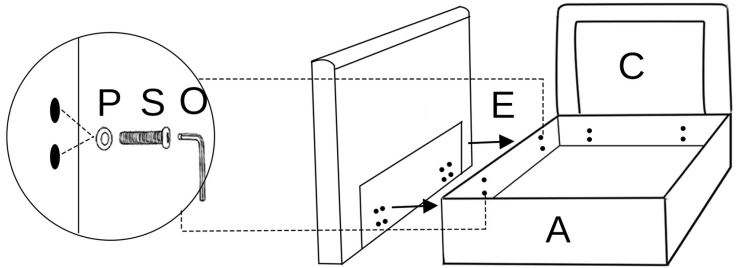

STEP2 Assemble the armrest

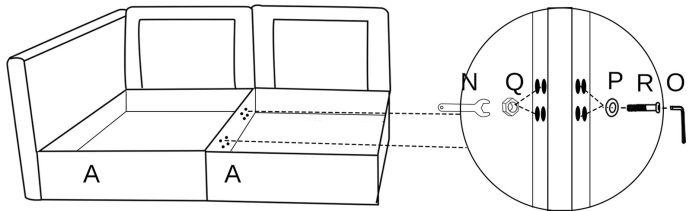

P		8pcs
R		8pcs
Q		8pcs

STEP3 Assemble the seatframe







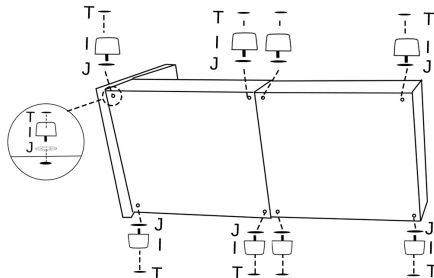



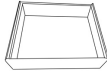

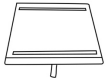
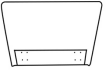





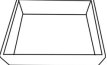

T		8pcs
I		8pcs
J		8pcs

STEP4 Assemble the leg





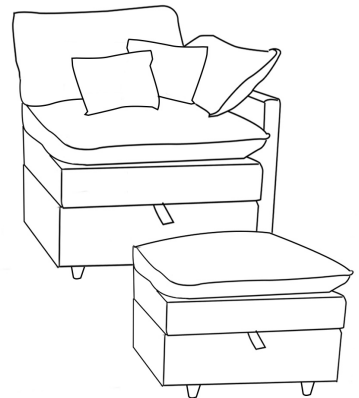

BOX B:

A	Seat frame		1PC
B	Seat cushion		1PC
C	Back frame		1PC
D	Storage box lid		1PC
E	Armrest		1PC
F	Back cushion		1PC
G	Pillow		2PCS
H	Arm pillow		1PC
L	Ottoman seat cushion		1PC
M	Ottoman storage box lid		1PC
K	Ottoman seat frame		1PC
I	Leg		8PCS

J	Gasket		8+1PCS
N	Spanner		1PC
O	Allen Key		1PC
P	Flat Washer		12+1PCS
Q	Nut		2+1PCS
R	Bolt M8		2+1PCS M8*65
S	Bolt M8		8+1PCS M8*50
T	Felt pad		8+1PCS





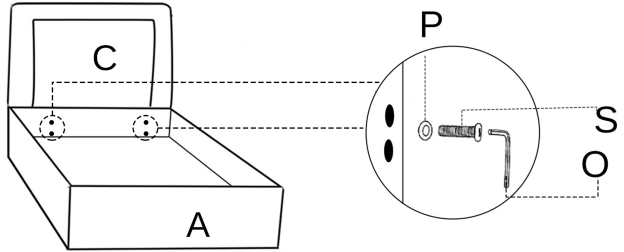

BOX B:

A		1pc
C		1pc
P		4pcs
S		4pcs
O		1pc



STEP1 Assemble the backrest



E		1pc
P		4pcs
S		4pcs
O		1pc

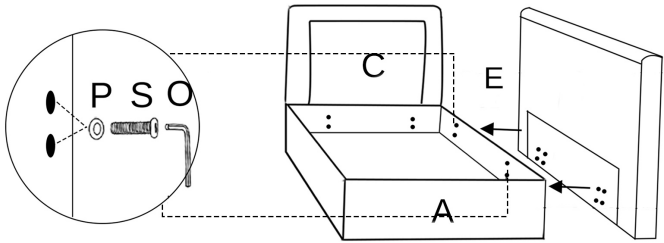

STEP2 Assemble the armrest

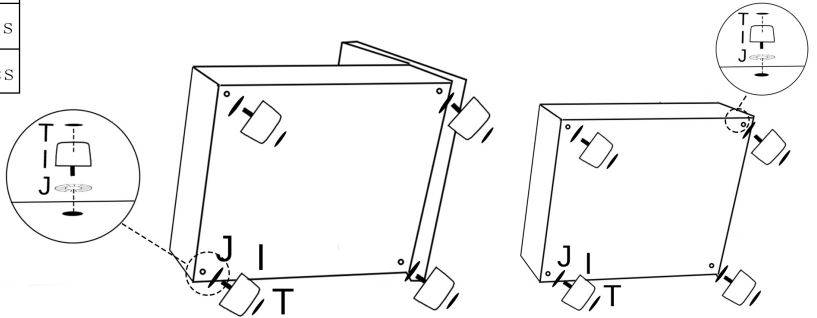

T		8pcs
I		8pcs
J		8pcs

STEP3 Assemble the leg



D		1PC
M		1PC
K		1PC

STEP4 Place the sofa storage lid

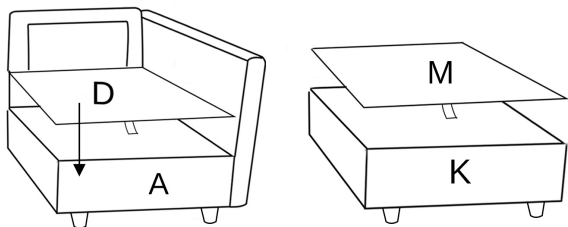







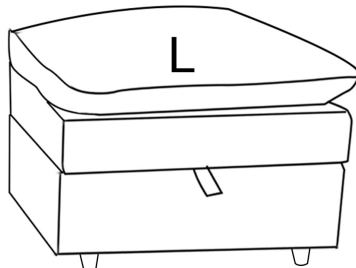
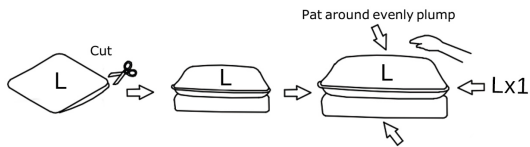
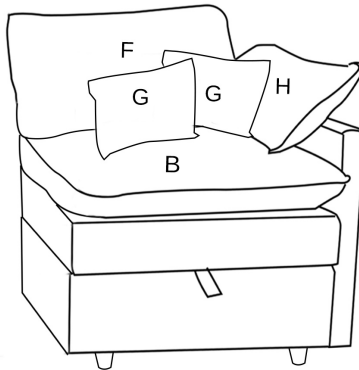
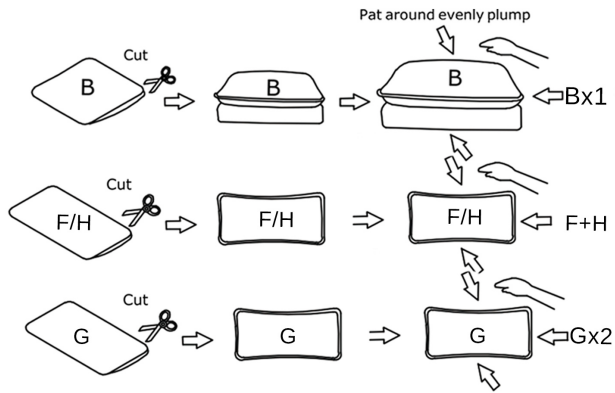

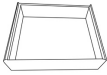

BOX B:

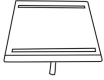

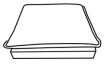

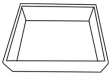

B		1pc
F		1pc
H		1pc
G		2pcs
L		1pc

STEP5 Open the vacuum-sealed packages and pat them for rebound.





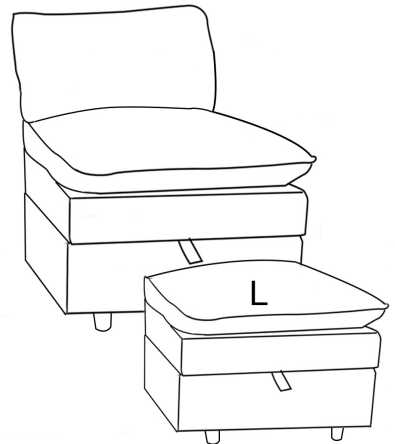

BOX C:

A	Seat frame		1PC
B	Seat cushion		1PC
C	Back frame		1PC
D	Storage box lid		1PC
E	Armrest		1PC
F	Back cushion		1PC
L	Ottoman seat cushion		1PC
K	Ottoman storage box lid		1PC
M	Ottoman seat frame		1PC
I	Leg		8PCS
J	Gasket		8+1PCS
N	Spanner		1PC

O	Allen Key		1PC
P	Flat Washer		12+1PCS
Q	Nut		4+1PCS
R	Bolt M8		4PCS M8*65
S	Bolt M8		4+1PCS M8*50
T	Felt pad		8+1PCS





BOX C:

A		1pc
C		1pc
P		4pcs
S		4pcs
O		1pc

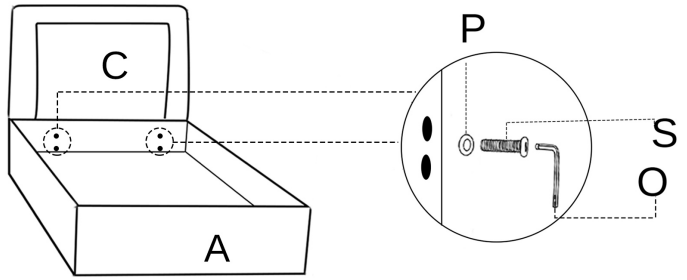

STEP1 Assemble the backrest

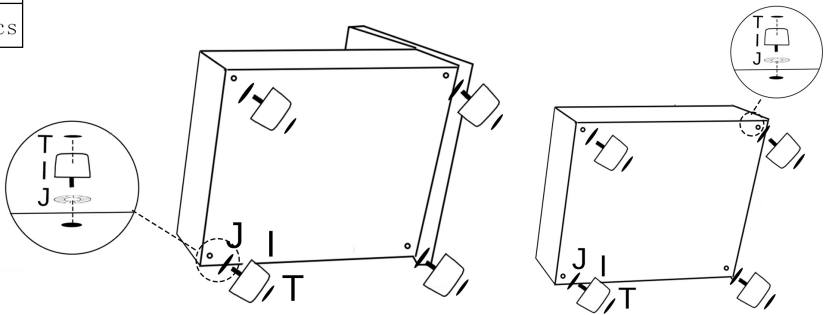

T		8pcs
I		8pcs
J		8pcs

STEP2 Assemble the leg



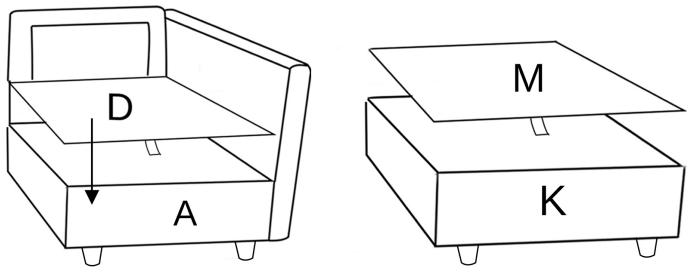

D		1PC
M		1PC
K		1PC

STEP3 Place the sofa storage lid





BOX C:

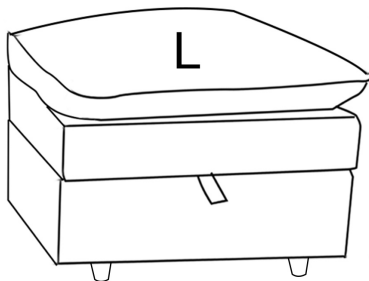
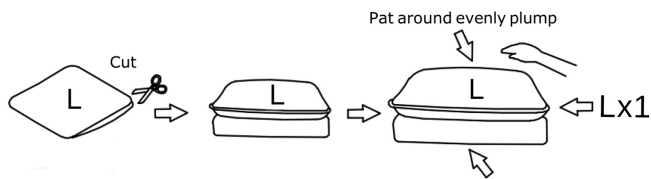
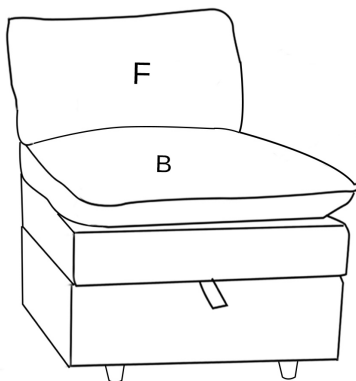
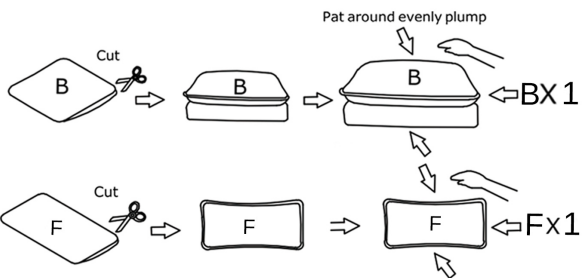

B		1pc
F		1pc
L		1pc

STEP4 Open the vacuum-sealed packages and pat them for rebound.

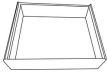
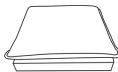



BOX D:

K	Ottoman seat cushion		1PC
L	Ottoman seat frame		1PC
M	Ottoman storage box lid		1PC

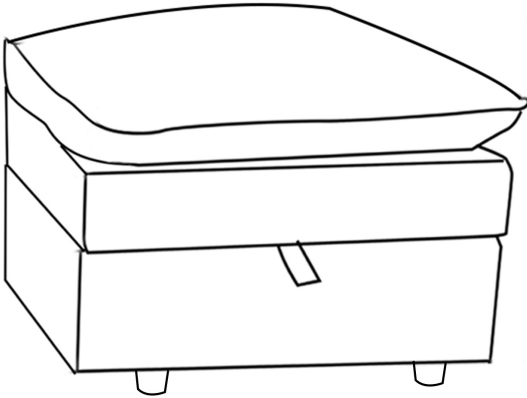
I	Leg		4PCS
J	Gasket		4+1PCS
T	Felt pad		4+1PCS





BOX D:

T	●	4pcs
I		4pcs
J		4pcs

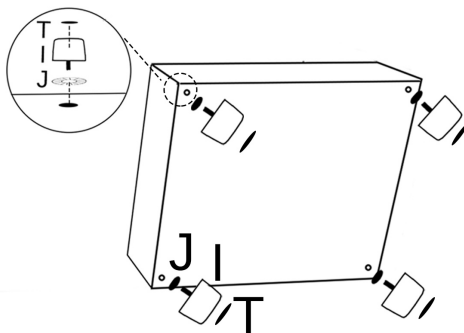
STEP1 Assemble the leg



M		1PC
K		1PC

STEP2 Place the sofa storage lid

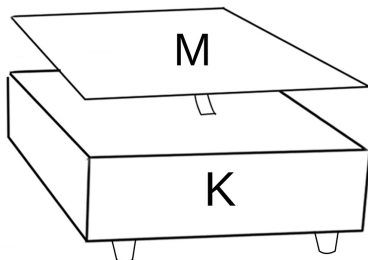

L		1pc
---	--	-----

STEP3 Open the vacuum-sealed packages and pat them for rebound.

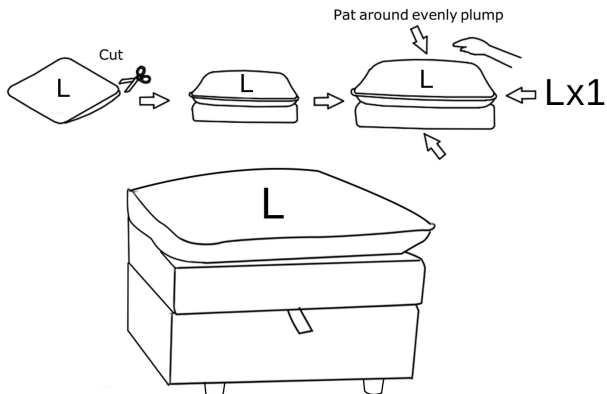

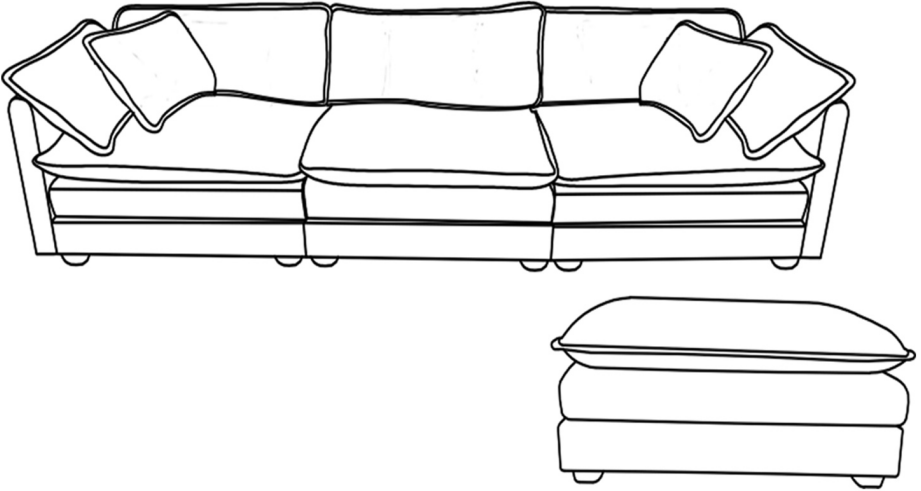

RETURN ISSUE

We offer 30-day returns, please feel free to contact us if you have any questions. Return requirements:

1. Original carton in good condition
2. No damage to the product Contact Customer Service Team

Email: sofabedservice@163.com

Phone: +1 877 589 7780