

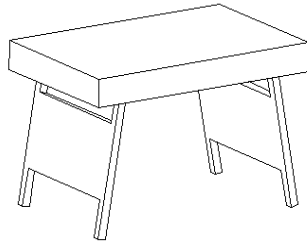

# Assembly Instructions

Caution : You must read this before you proceed

## Snack Table



### Part List

Label	Picture	Description	QTY
A		Snack Table	1

### Hardware

Label	Picture	Description	QTY
①		Bolt (M6*30mm)	3

### Assembly Preparation

Before Beginning Assembly:

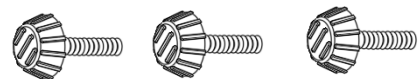
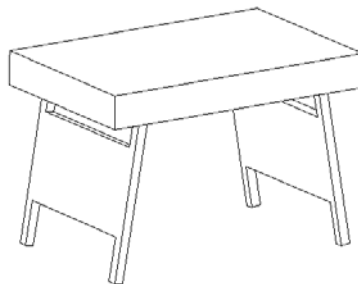

• Read instructions, cover to cover-



• Have 2 adults on hand for assembly-



• Do not assemble on flooring or carpet-



• Assemble on a clean non-marring surface (packing foam)-



• Save all packaging until finished-

# Assembly Steps

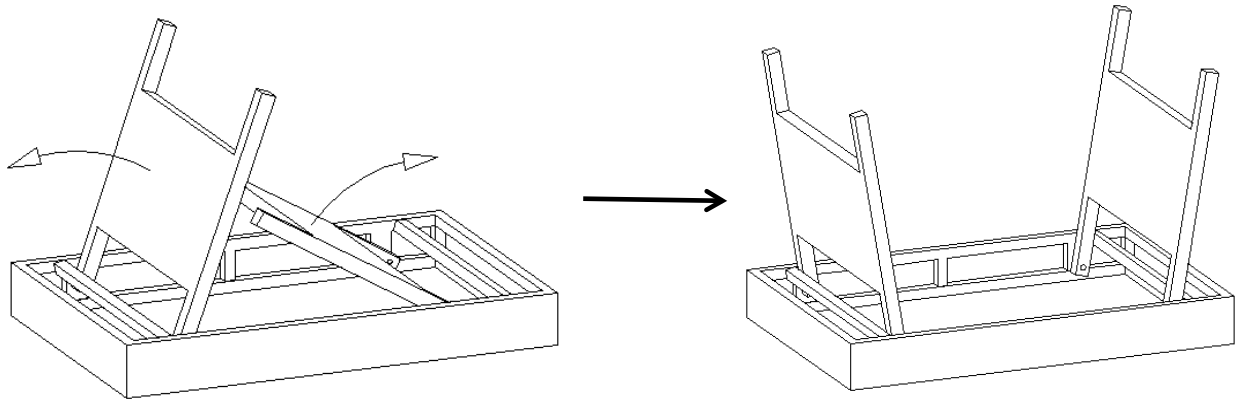

Open the carton and place the Snack Table onto a clean, non-marring surface as shown in Picture

## Step 1

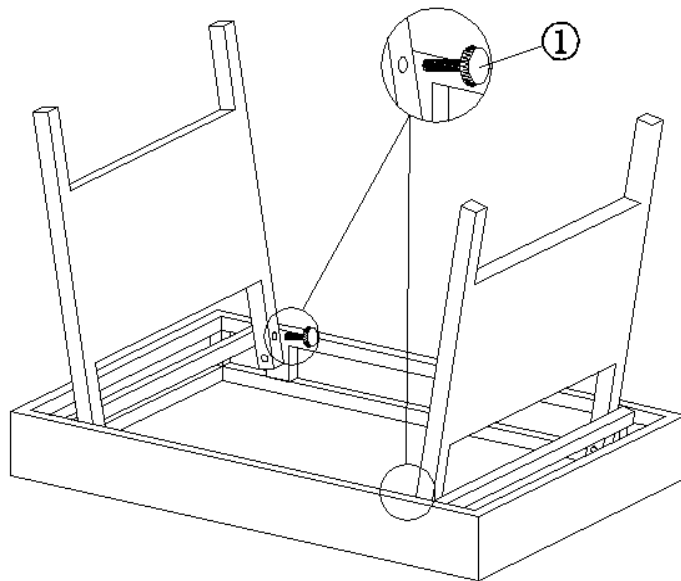





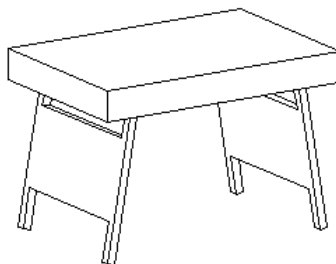















Attach the Table Leg onto the support bar on the table top using Bolt (①) as above picture show.  
**Fully tighten the Bolts.**

## Step 2



Turn the Snack Table up.  
Your Snack Table is ready for use.  
This Snack Table can only be used on a flat, level surface.

## Care & Maintenance

-   ● Do not put hot items directly on furniture surface
  -   ● Do not clean furniture with harsh cleansers or polish.
  -   ● To obtain the longest lifespan of your outdoor products, minimizing exposure to direct sunlight is recommended.
  -   ● Children should not climb or jump on the furniture.
  -   ● Do not write on furniture without a padded barrier to protect the surface.
  -   ● To obtain the longest lifespan of your outdoor products, avoid extended and lengthy exposure to rain, snow, and direct sunshine. Whenever possible cover the product and /or place under patio or awnings.
  -   ● Not for commercial use. For residential use only .
  -   ● Stains may be removed with mild soap solution and damp cloth.
  -   ● Keep away from sources of ignition.
- 
-   ● Dust and pick-up spills using a clean, non-colored, lint-free cloth .
-