

# Assembly instructions

**Caution: You must read this before you proceed**

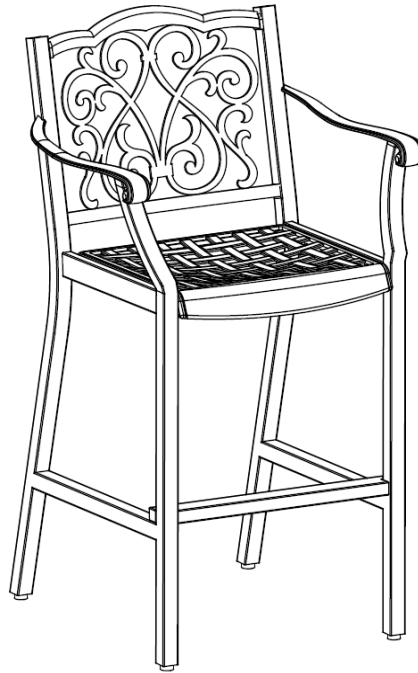

## **Barstool**





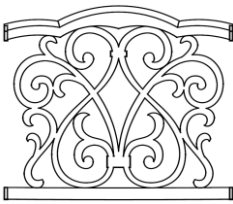
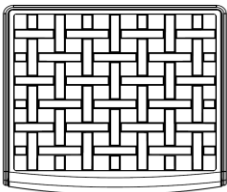
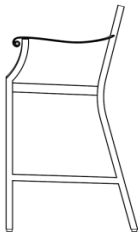

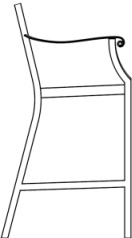

**CAUTION: This Barstool is NOT a TOY.**  
Keep your child / children at bay in the process of assembly.

### Parts list

NO.	Picture	Description	QTY
A		Backrest	1
B		Seat	1
C		Right arm with pre-attached Leveller	1

D		Left arm with pre-attached Leveller	1
E		Footrest	1

### Hardware

①		Bolt(M8*22mm)	9
②		Spring Washer(M8)	12
③		Washer(M8)	9
④		Big Washer(M8)	3
⑤		Bolt(M8*45mm)	3
⑥		Allen Key(M8)	1

### Assembly Preparation

Before Beginning Assembly:

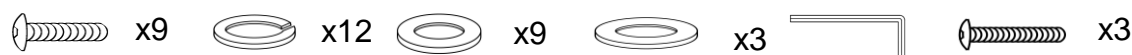
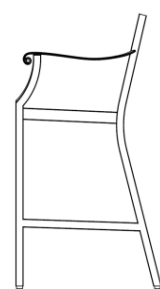
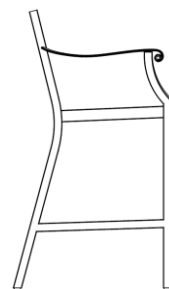
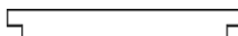
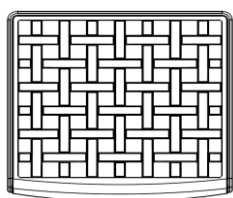
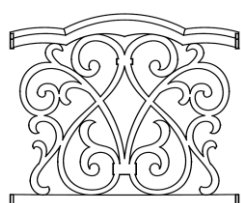

- Read instructions, cover to cover-



- Have 2 adults on hand for assembly-



- Do not assemble on flooring or carpet-



- Assemble on a clean non-marring surface (packing foam)-



- Save all packaging until finished-

## Assembly Step

### Overview

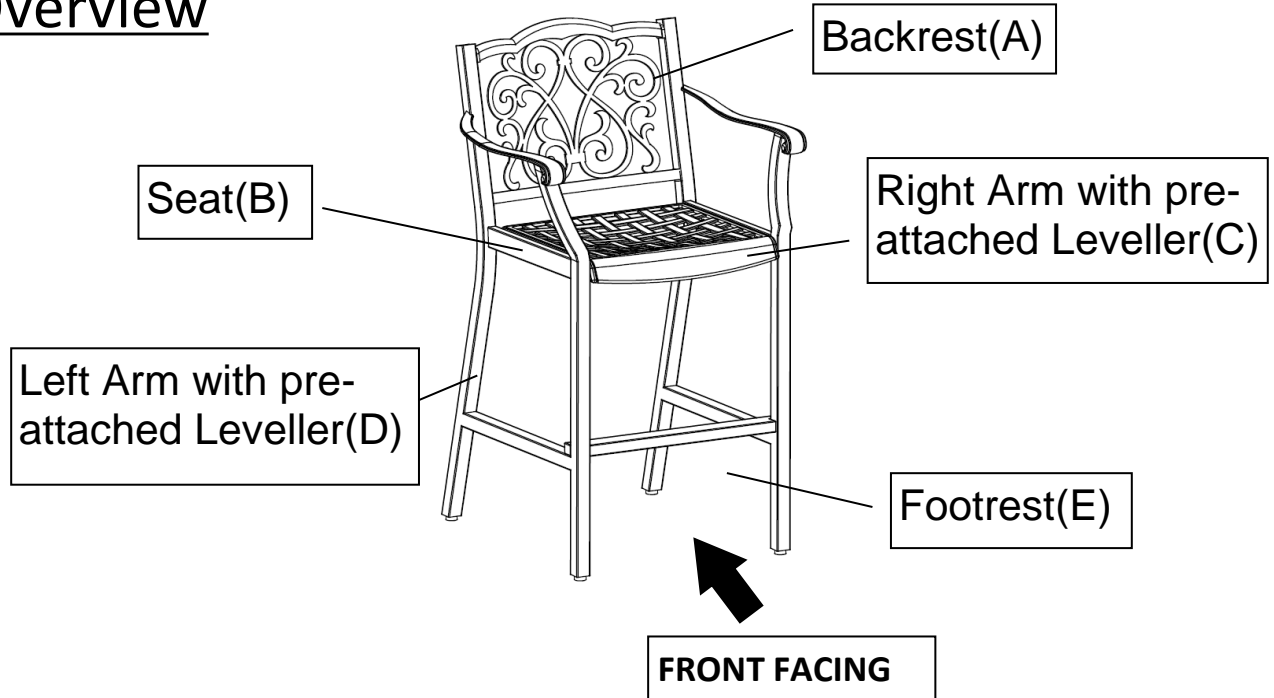

This Barstool has multiple parts and may require up to 30 minutes to assemble.

To give you an overview of the Barstool parts, the above picture is to help you put the various parts into perspective.

Please read through the instructions below to familiarise yourself with the parts and steps before assembly.

### Step 1

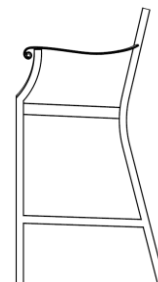
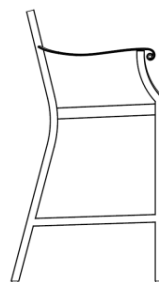
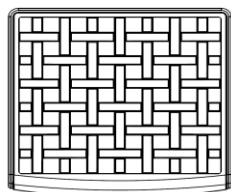
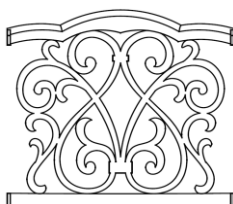

Unpack and place all parts onto a clean soft surface.

## Step 2

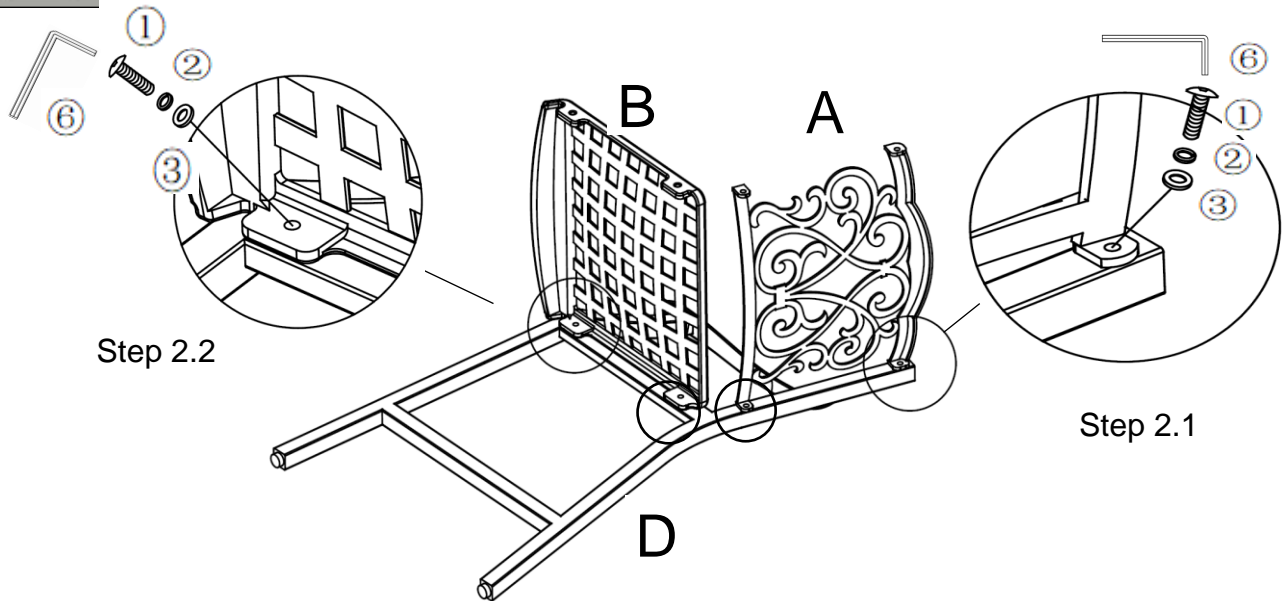

- 2.1)** Attach Backrest(A) to Left Arm with pre-attached Leveller(D) with Bolts(①), Spring Washers(②) and Washers(③) by Allen Key(⑥).
- 2.2)** Attach Seat(B) to Left Arm with pre-attached Leveller((D) with Bolts(①), Spring Washers(②) and Washers(③) by Allen Key(⑥).
- DO NOT OVERTIGHTEN.**

## Step 3

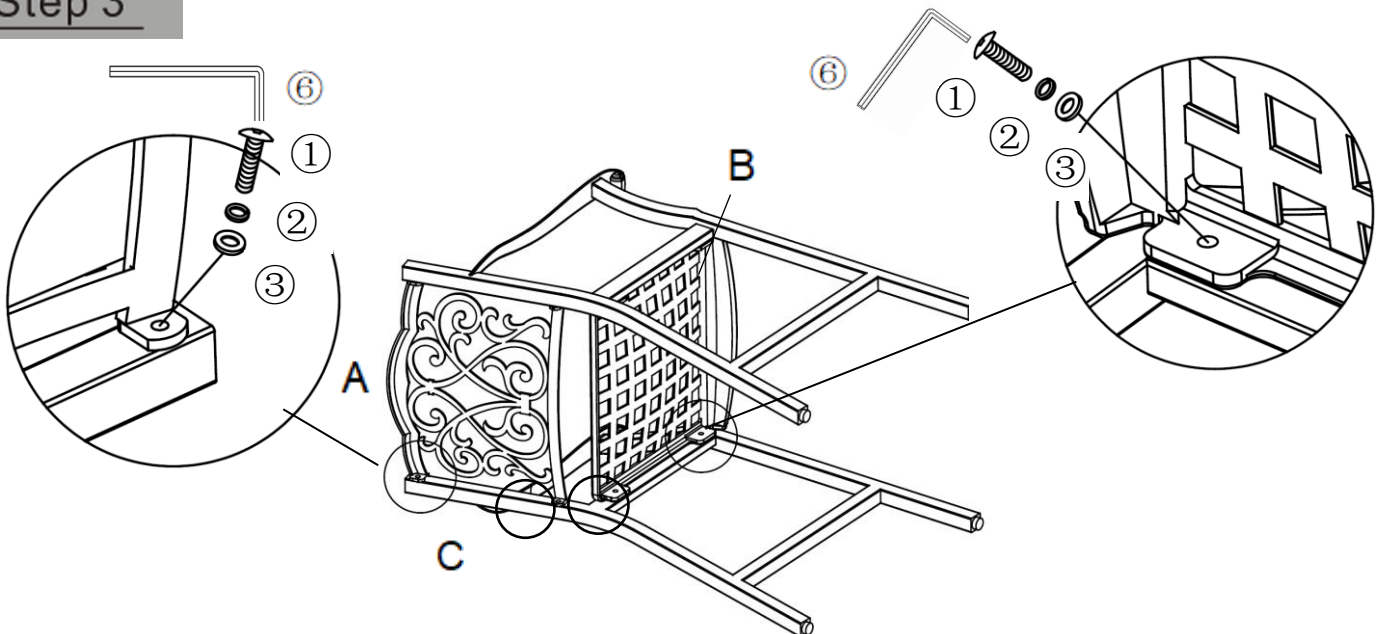

Repeat step 2 to assemble Backrest(A) and Seat(B) to Right arm with pre-attached Leveller(C) as pix shown.

#### Step 4

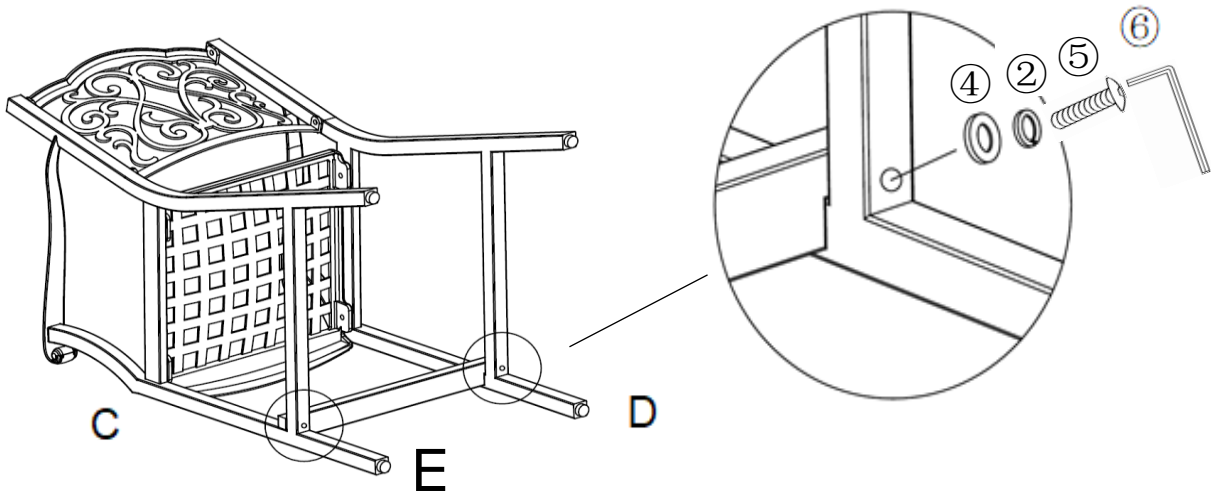

Attach Footrest(E) to Side Rail of Right Arm with pre-attached Leveller(C) and Left Arm with pre-attached Leveller(D) using Bolts(5), Spring Washers(2) and Big Washers(4) by Allen Key(6).

**DO NOT OVERTIGHTEN.**

#### Step 5

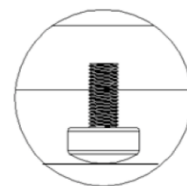

Adjust height  
for balance

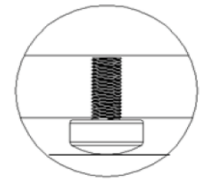

Adjust low for  
balance

Adjust Pre-installed  
Levellers  
height for balance

Turn the Barstool rightside up.



















Adjust the pre-installed Leveller until the Barstool is level with the ground.

Then, proceed to tighten all Bolts.

Your Barstool is ready for use.

**Caution: This Barstool can only be used on a flat, level surface.**

## Care & Maintenance

-   • Do not put hot items directly on furniture surface.
  -   • Do not clean furniture with harsh cleansers or polish.
  -   • To obtain the longest lifespan of your outdoor products, minimizing exposure to direct sunlight is recommended.
  -   • Children should not climb or jump on the furniture.
  -   • Do not write on furniture without a padded barrier to protect the surface.
  -   • To obtain the longest lifespan of your outdoor products, avoid extended and lengthy exposure to rain, snow, and direct sunshine. Whenever possible cover the product and /or place under patio or awnings.
  -   • Not for commercial use. For residential use only .
  -   • Stains may be removed with mild soap solution and damp cloth.
- 
-   • Dust and pick-up spills using a clean, non-colored, lint-free cloth .