

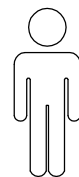

60'

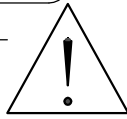
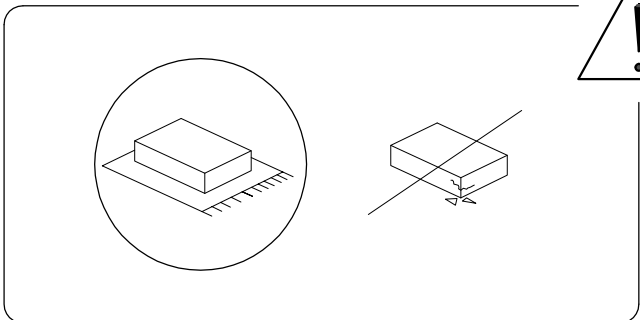
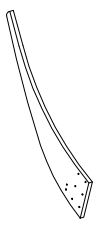

1

<b>A</b>	<b>B</b>	<b>C</b>	<b>D</b>	<b>E</b>
				
<b>x 2</b>	<b>x 2</b>	<b>x 2</b>	<b>x 2</b>	<b>x 35</b>

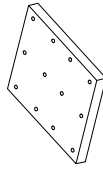
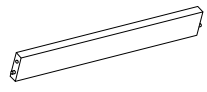
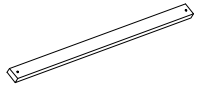
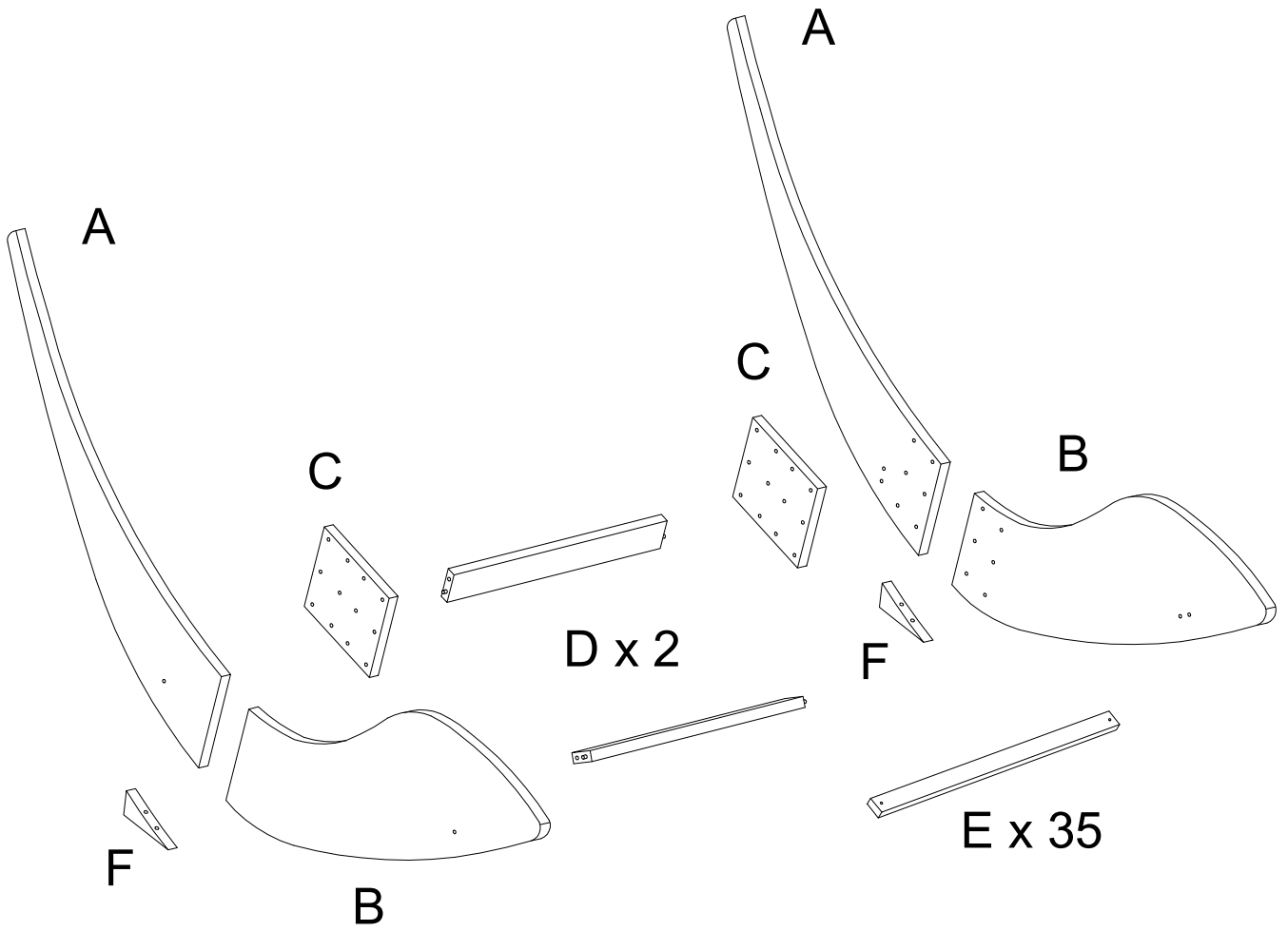

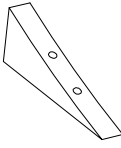
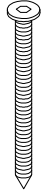
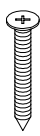
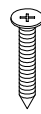
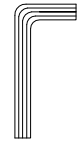
<b>F</b>	<b>G</b>	<b>H</b>	<b>I</b>	<b>J</b>
				
<b>x 2</b>	<b>6 x 60 x 4</b>	<b>4 x 30 x 28</b>	<b>4 x 25 x 70</b>	<b>x 1</b>

1

A



x 2

F

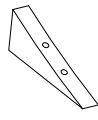

x 2

H

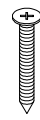

4  
x  
30

x 4

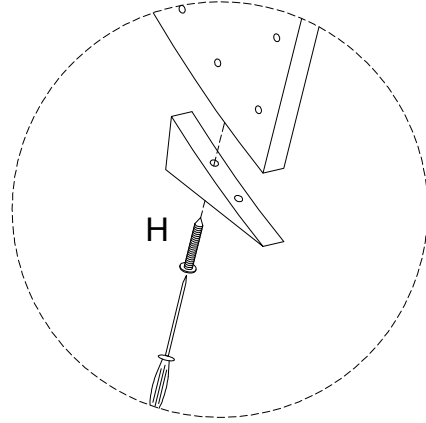
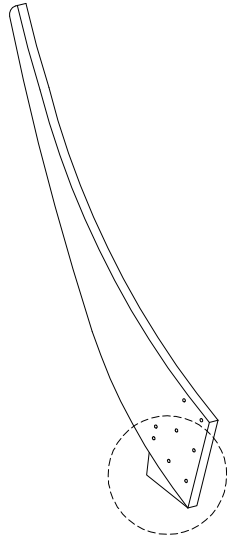

2

B



x 2

C



x 2

H

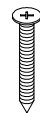

4  
x  
30

x 24

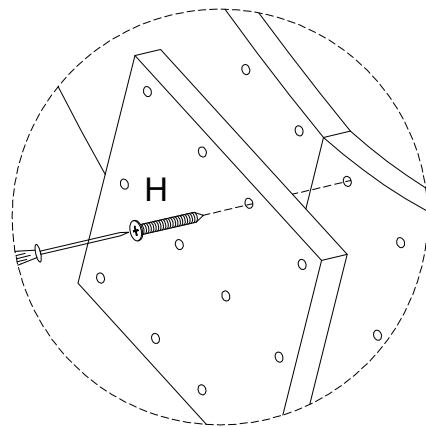
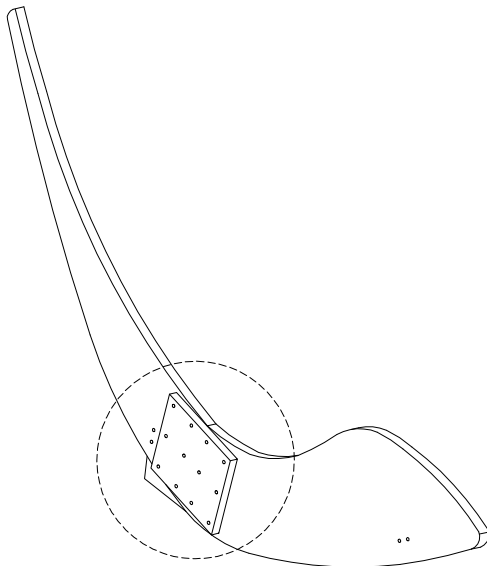

3

D

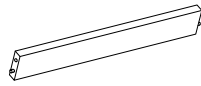

x 2

G

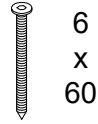

x 4

J

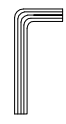

x 1

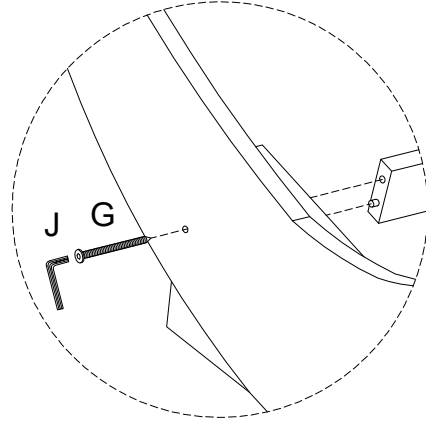
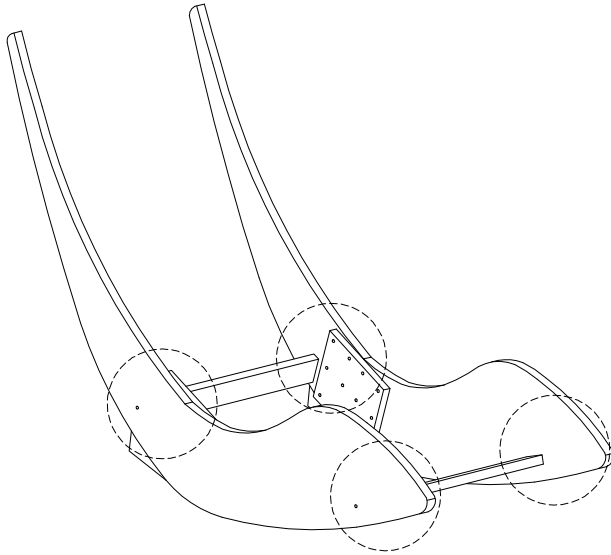

4

E

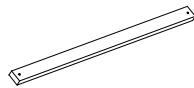

x 35

I

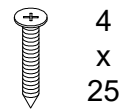

x 70

