

ASSEMBLY INSTRUCTION FOR ACME FURNITURE

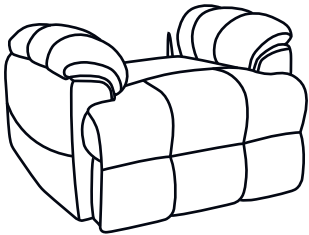

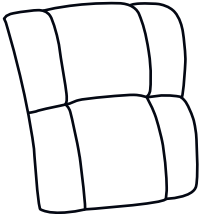
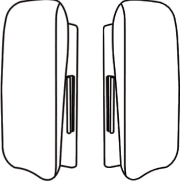

MODEL#LV02998

Thank you for purchasing the quality product. Be sure to check all packing material carefully for small parts which may have come loose inside the carton during shipment. Separate, Identify and count all parts and metal hardware. Compare with all parts listed to be sure all parts are present. If any part(s) are missing or damaged, please contact your local furniture dealer. For efficient and speedy service, please indicate the model number and code letter of part(s) needed.

COMPONENT PARTS

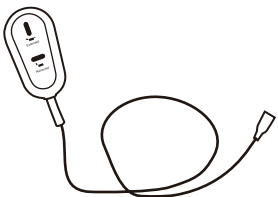
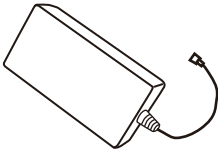
DESCRIPTION	PART NAME	Q'TY(PCS)
①:Chair Seat		1 PC
②:Chair Back		1 PC
③:Ears(Left&Right)		2 PC

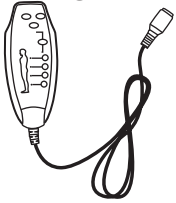
HARDWARE REQUIRED

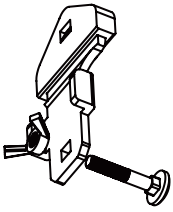
A:Motor Remote 	B:Transformer 	C:Plug 
D:Massage Remote 	E:Power Cord 	F:Anti-fall Brackets*2 

Attention

***Some number parts listed on the instruction sheet may not be in parts bag as they may be assembled. Carefully check parts and packing materials prior to ordering replacements. ***

HOW TO ASSEMBLE:

STEP 1

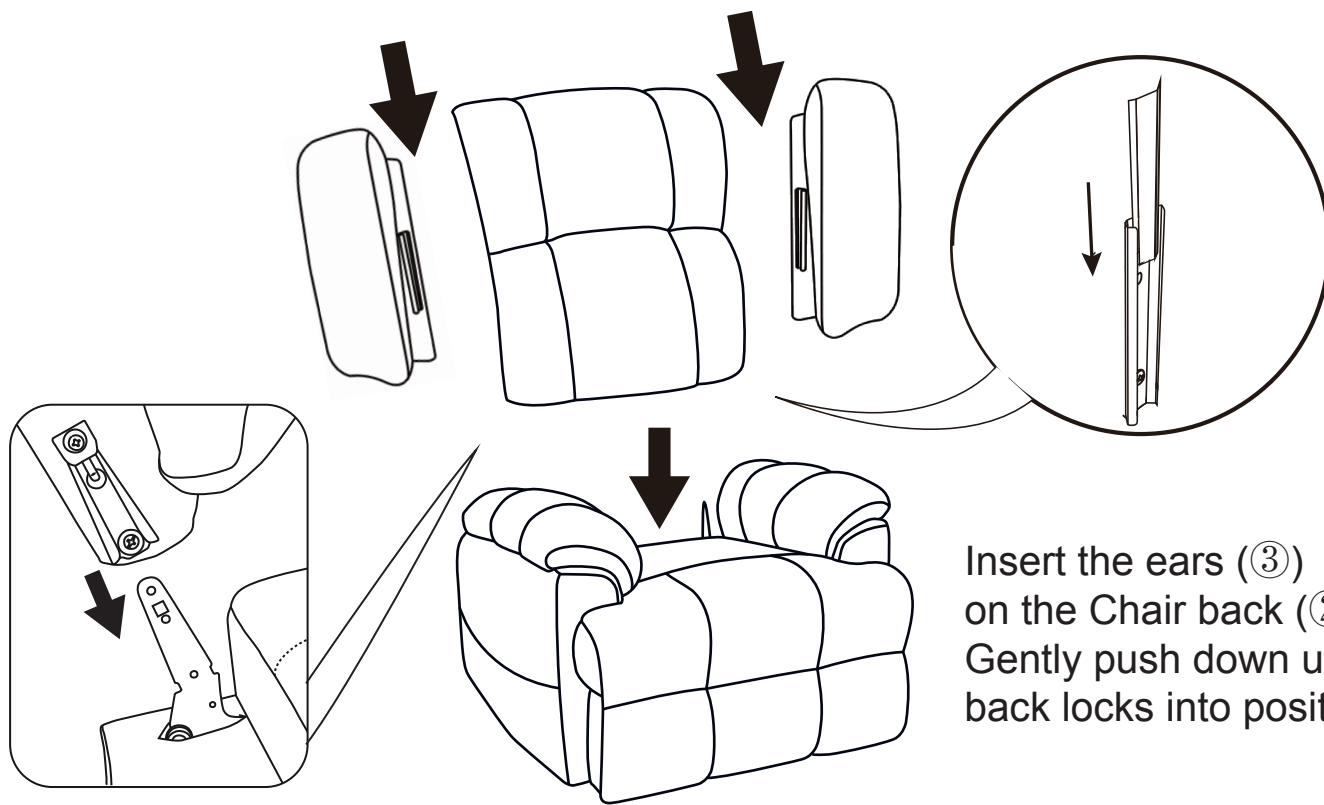

Insert the ears (③) on the Chair back (②), Gently push down until the back locks into position.

Insert the Chair back (②) on the Chair seat (①). Gently push down until the back locks into position.

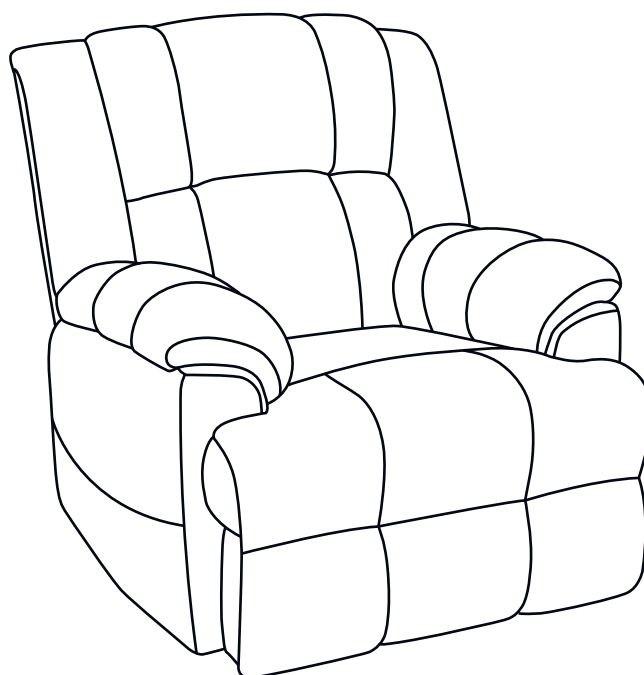

HOW TO CONNECT THE MOTOR WIRES:

STEP 2

No.1: Wire connect the motor and the Motor Remote(A),

No.2: Wire connect the motor and transformer (B).

No.3: Plug(C) connect the transformer (B)

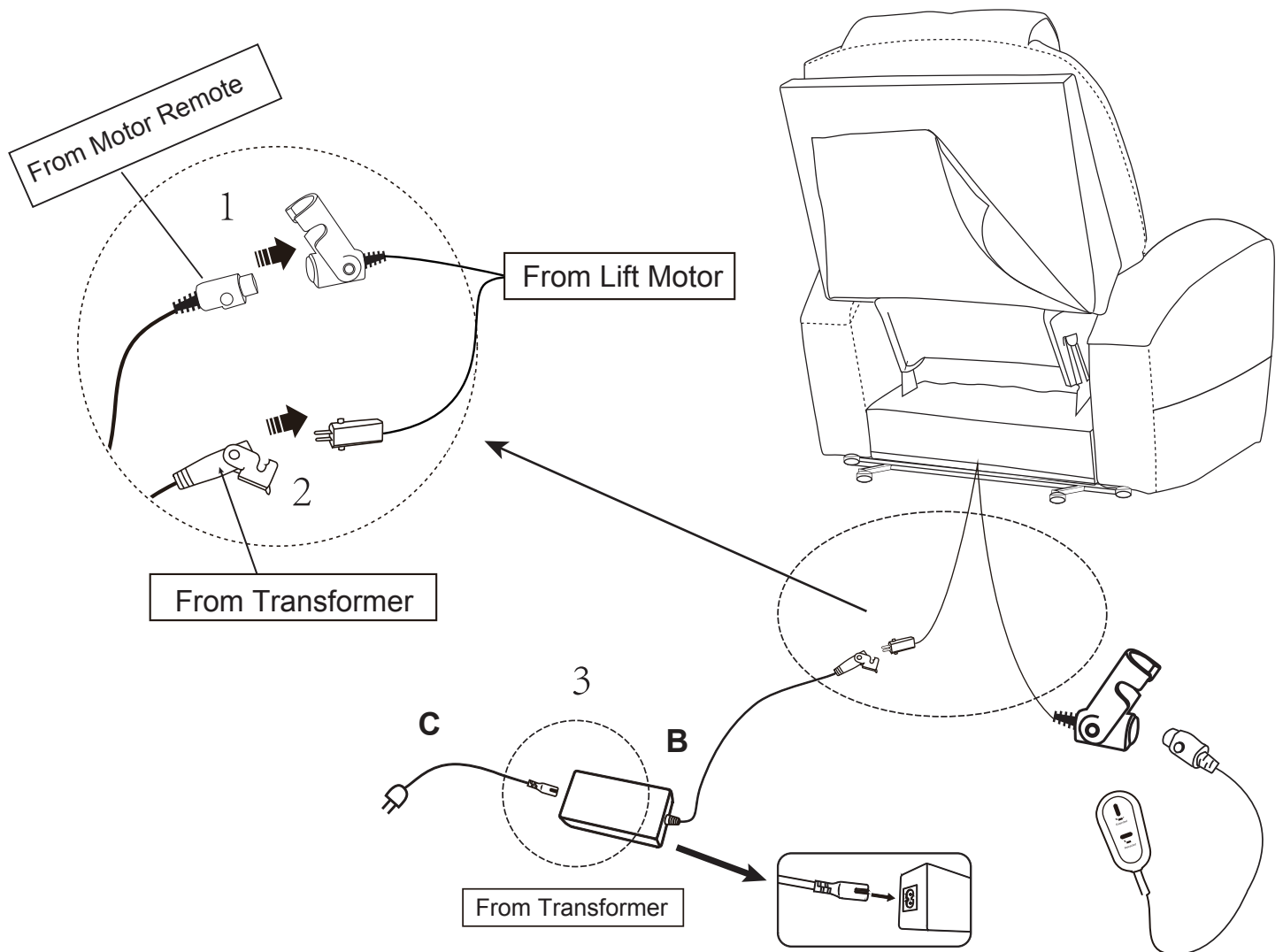

HOW TO CONNECT THE MOTOR WIRES:

STEP 3

There are 4 wires coming out of the backrest, if you find that the wire is missing, check to make sure it's not stuck between the backrest and the Seat before you make the connection.

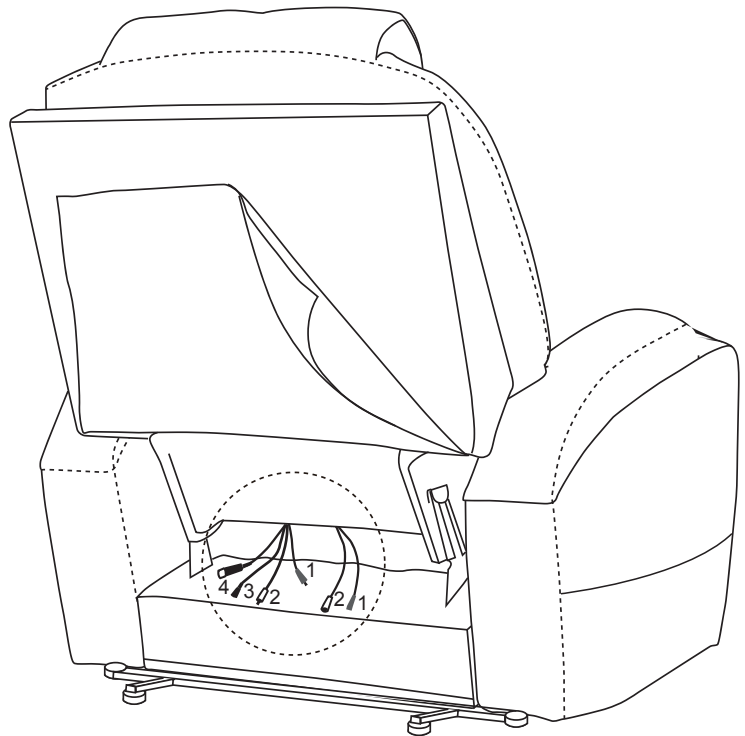

Chair back (②)

Chair seat (①)

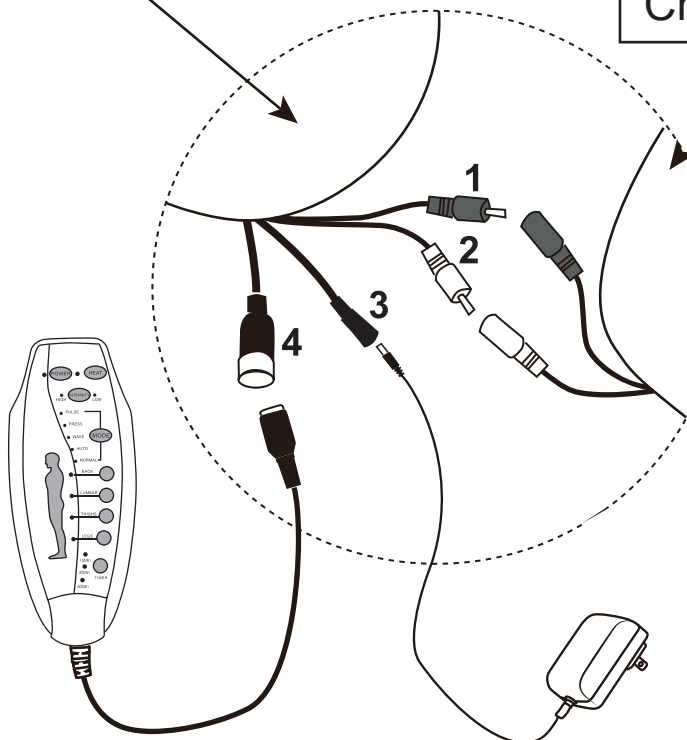

Wire 1: RED wire from the backrest connect to the RED wire from the seat.

Wire 2: WHITE wire from the backrest connect to the WHITE wire from the seat.

Wire 3: BLACK smaller wire from the backrest connect to the POWER CORD(E).

Wire 4: BLACK bigger wire from the backrest connect to the Massage Remote(D).

Massage Remote(D)

Power Cord(E)

HOW TO ASSEMBLE THE ANTI-FALL BRACKETS:

STEP 4

Butterfly nut up, screw
bolt down

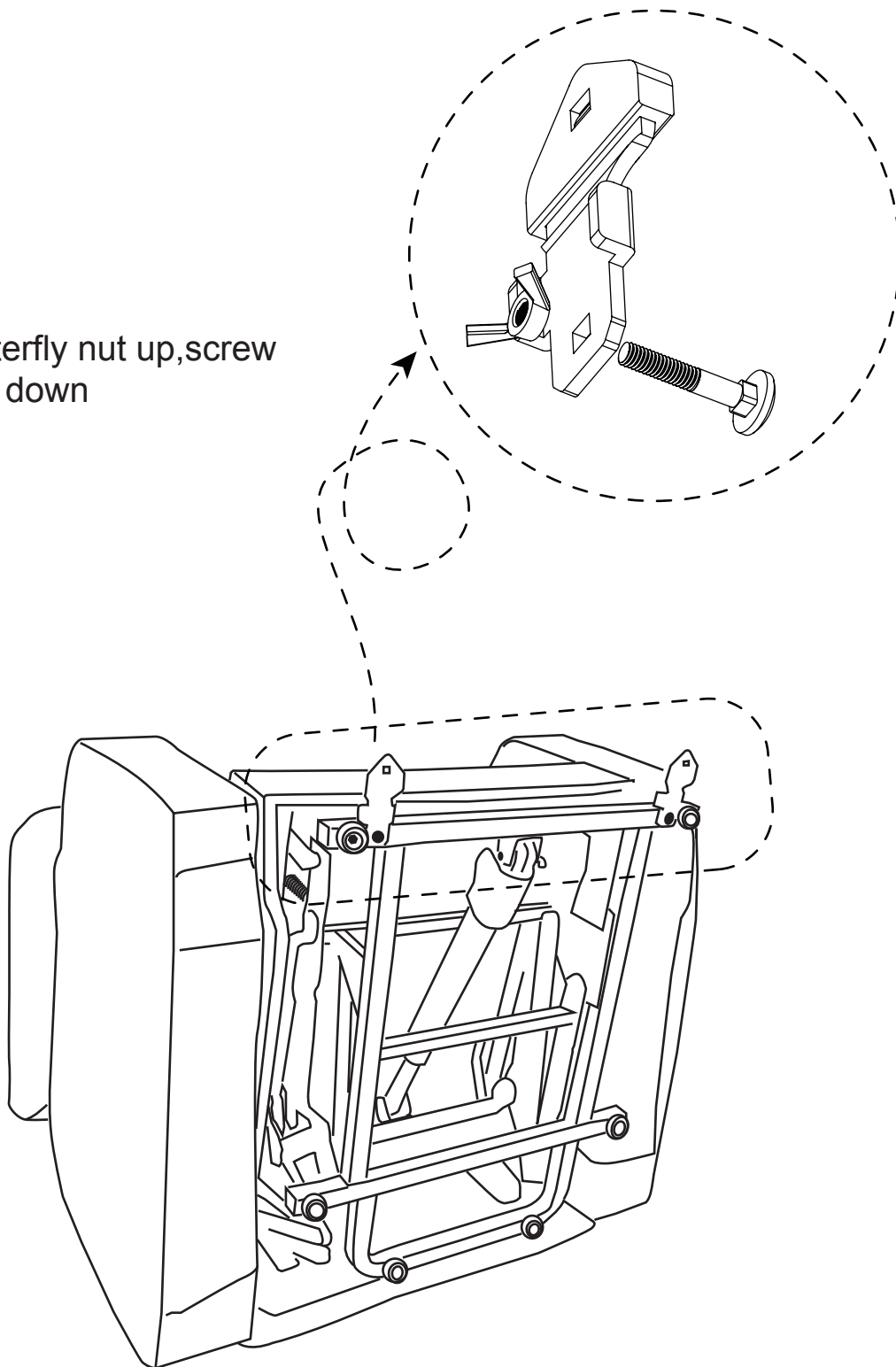

Find a small bag in the accessories box. Take out **Anti-fall Brackets*2(F)** from the small bag. Assemble the two Anti-fall Brackets as shown on the bottom of mechanism to avoid toppling and falling.

HOW TO USE MOTOR REMOTE:

How to recline?

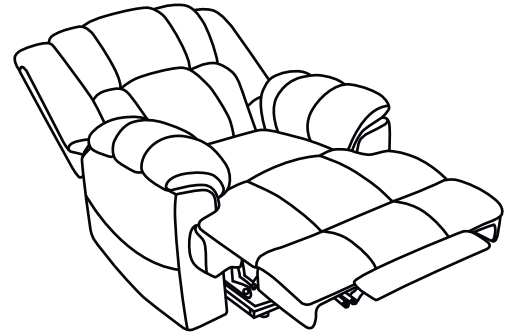
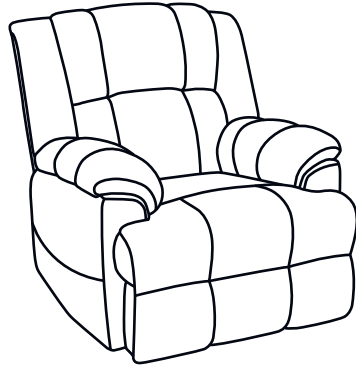
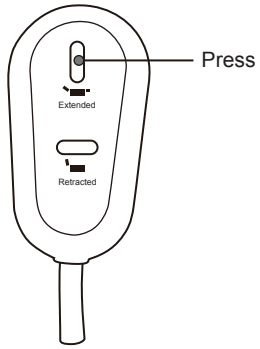

How to get footrest latch down and stand?

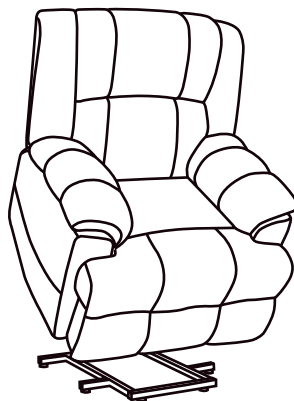
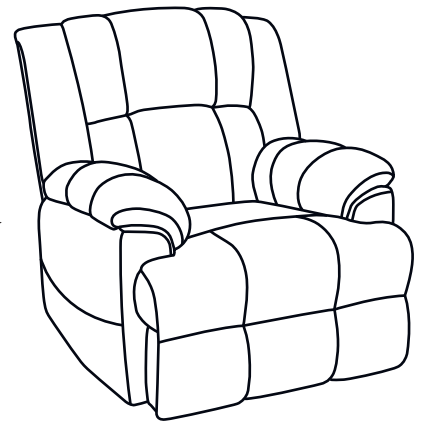
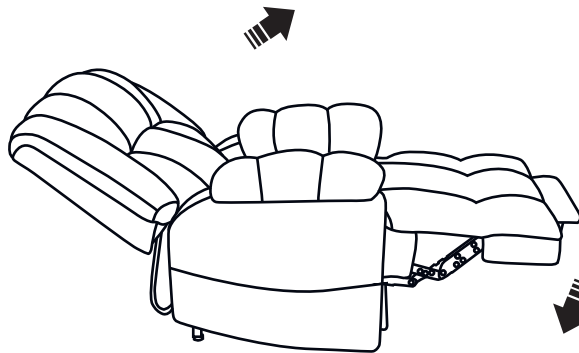
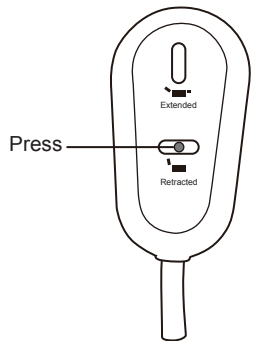

HOW TO USE MASSAGE REMOTE:

