

ASSEMBLY INSTRUCTIONS

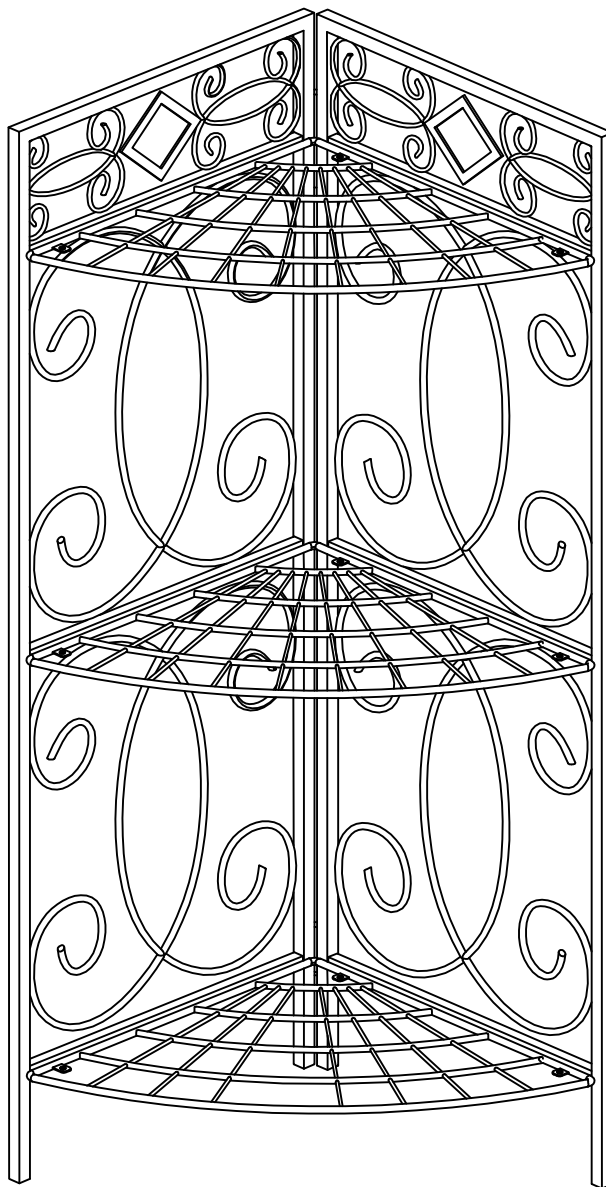

Bathroom Rack





NOTE TO CUSTOMERS:

- For ease and speed of assembly we recommend that before you commence each step of the assembly that you identify all the parts required to complete that step.
- We recommend that where possible you allow sufficient space to assemble the item as close as possible to the place where it will be once assembled.
- For the protection of your furniture we recommend that the product is placed on protected surfaces during assembly to prevent any damage.
- During assembly do not over tighten, as this may damage the product.
- Please ensure you retain all the product packaging until the item completely assembled.
- Please periodically check all fittings and re-tighten as necessary.
- It is recommended that this item should be assembled by two adults.

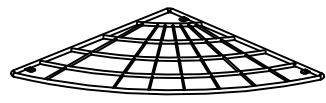
Part List

A1  Right Frame	Quantity of 1 A2  Left Frame	Quantity of 1 A3  Net Rack
--	--	--

Hardware List

B1  Bolt	Quantity of 9 B2  Nut
---	---

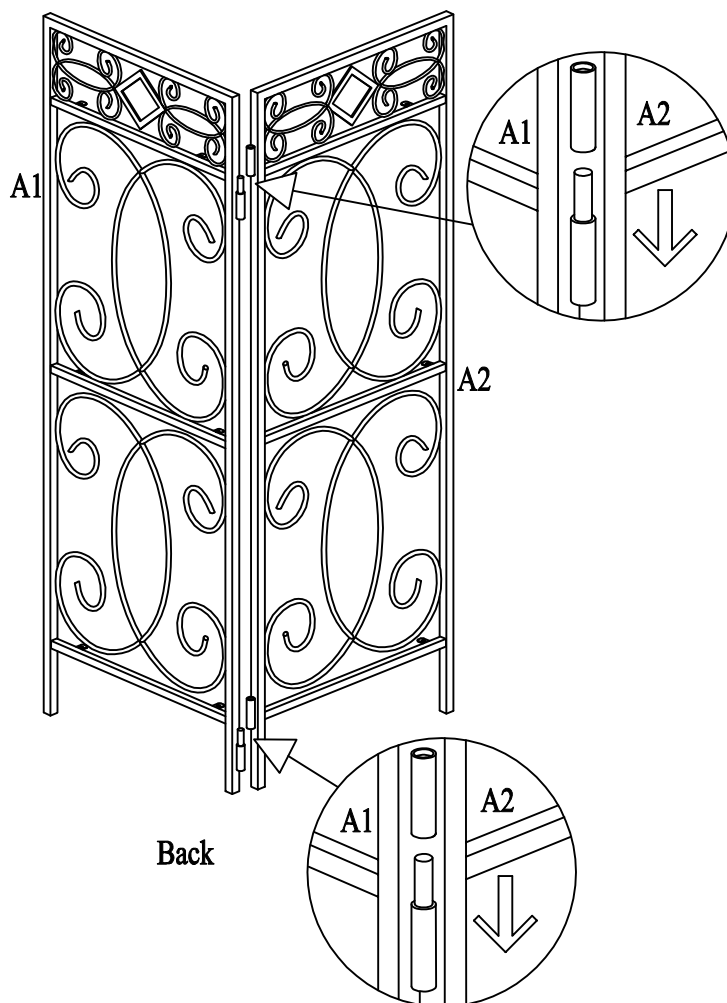

STEP 1

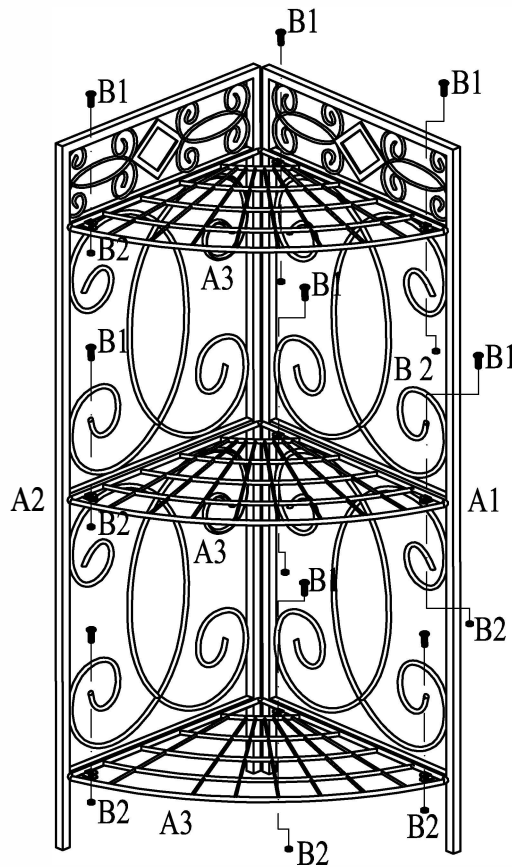

Attach Left Frame A2 to Right Frame A1 as shown above.

STEP 2



B1		9pcs
B2		9pcs

Assemble Racks A3 to Frames A1&A2 using Bolts B1 and Nuts B2.

APPENDIX: Dimension of Hardwares in this AI.

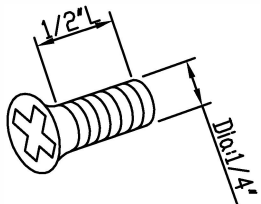
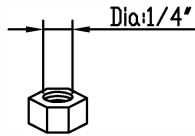
<p>B1.</p>  <p>Bolt</p>	<p>B2.</p>  <p>Nut</p>
--	---