

Plant Stand

The assembly instructions

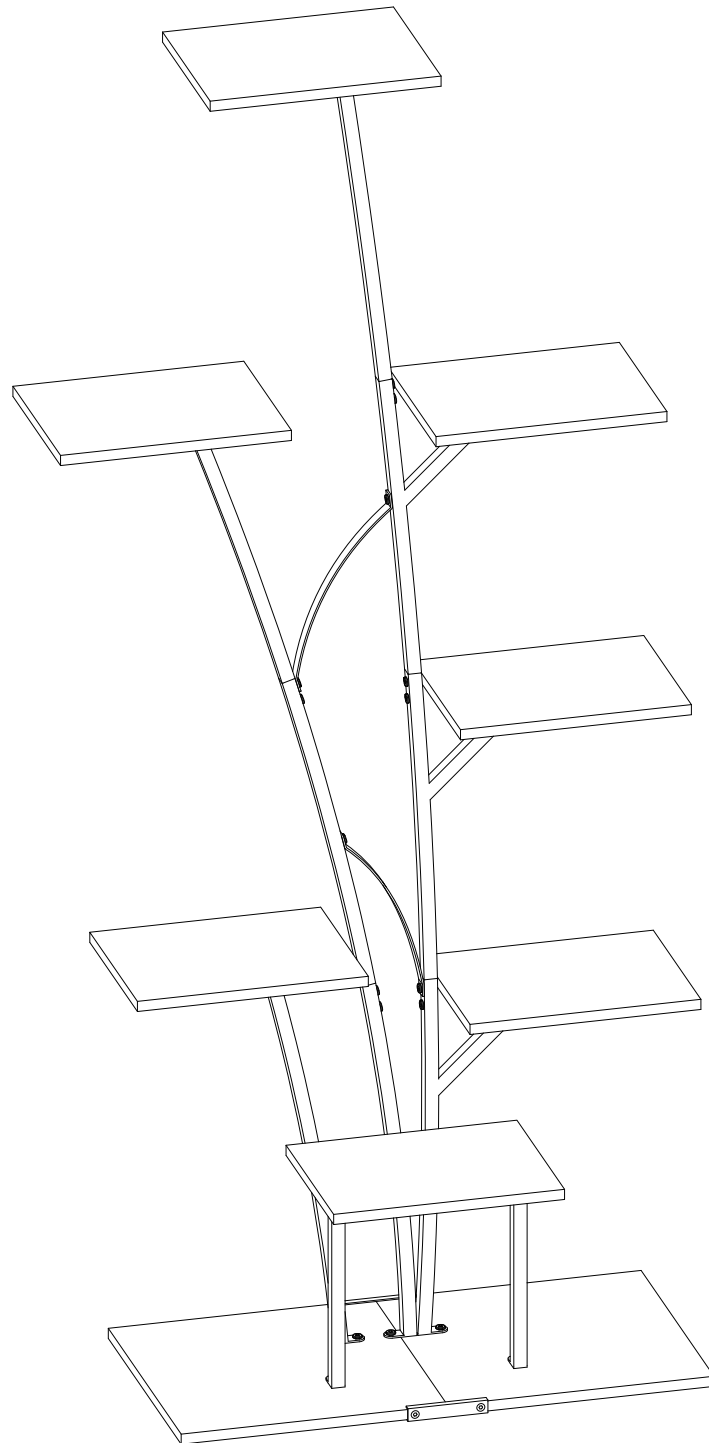

Thank you for purchasing our products, please read the instructions carefully before you assemble the product.

MATTERS NEEDING ATTENTION

Please follow the instruction manuals and use a pad to avoid damage during assembly.

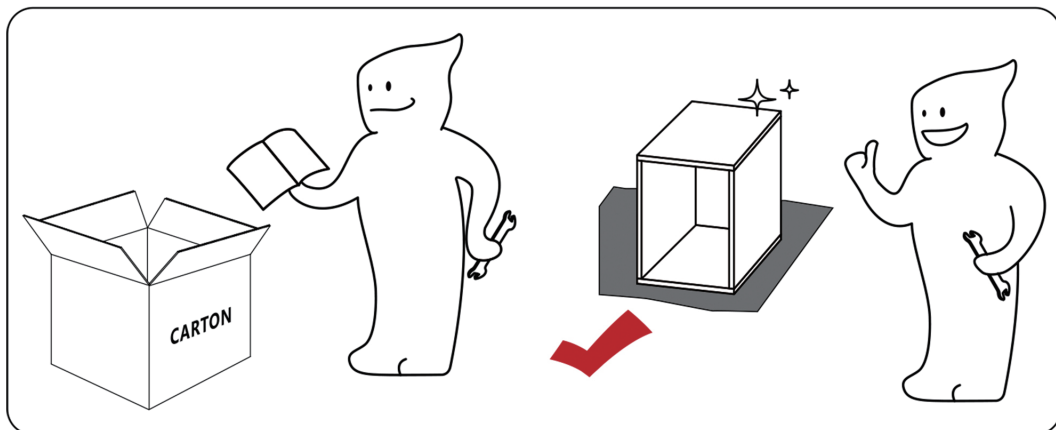
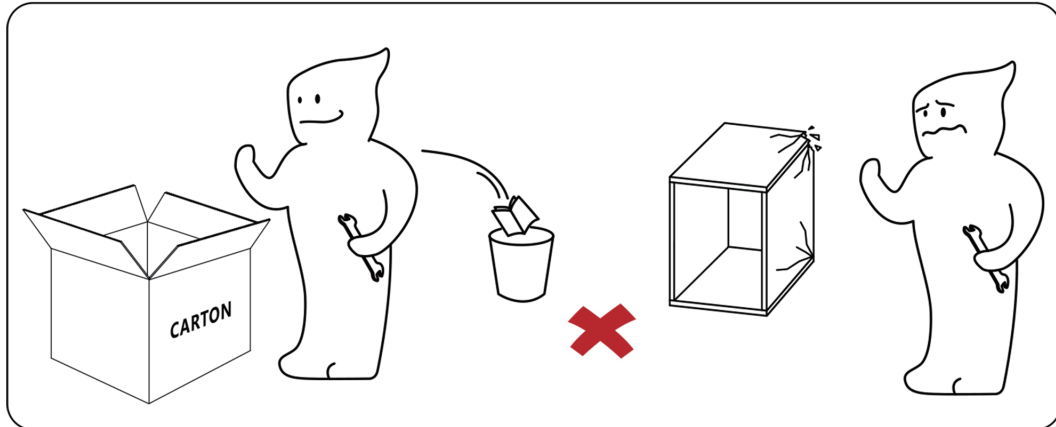

1  Not intended for use by children.





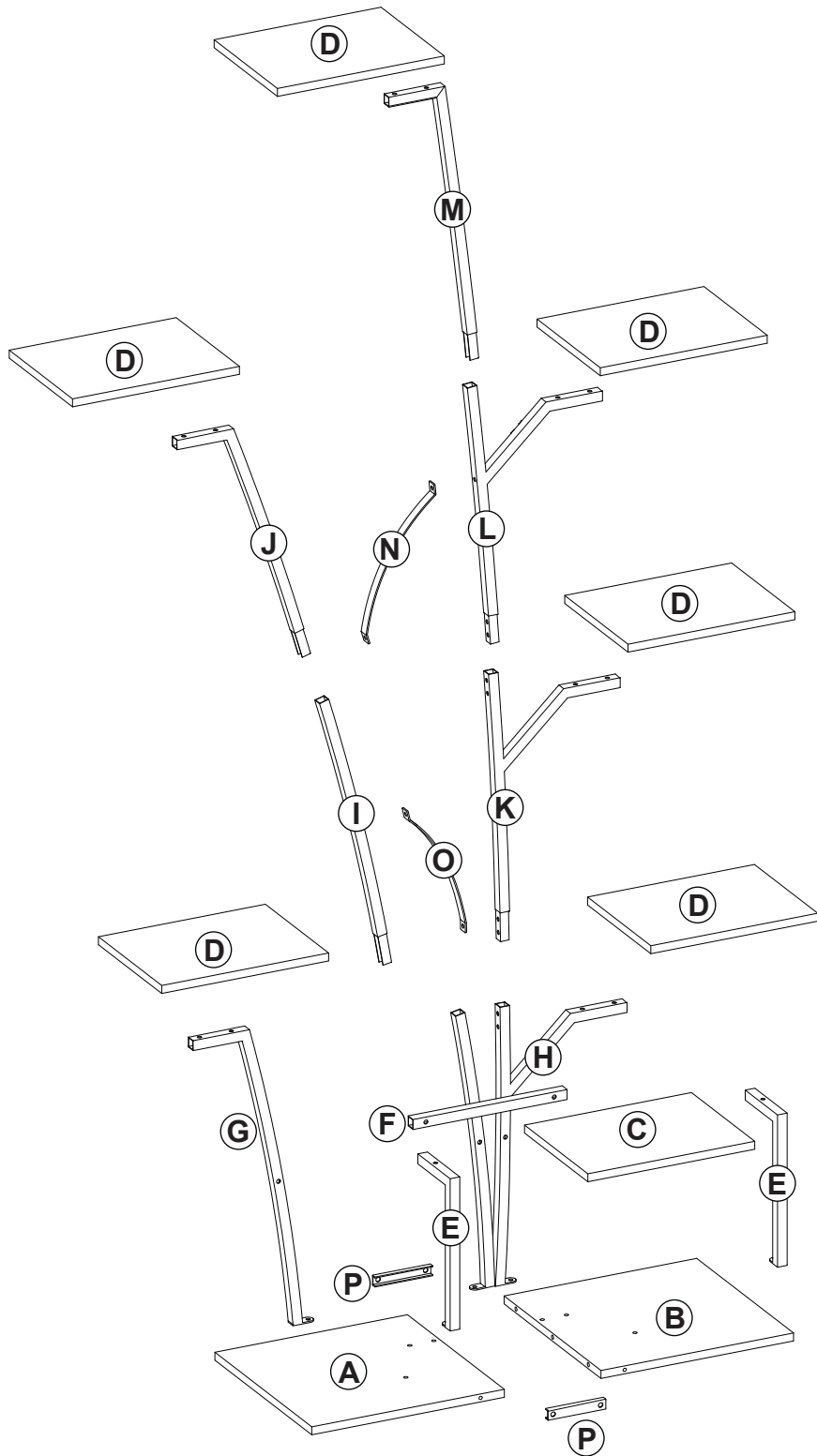

2  Keep away from fire or other heat sources.



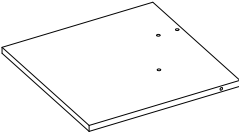
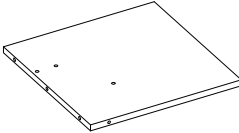
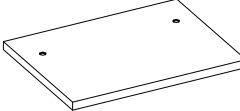
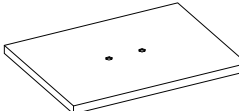
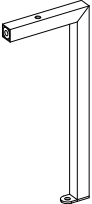
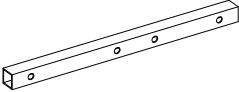
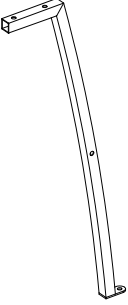
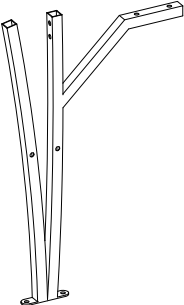

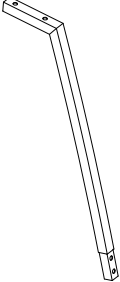
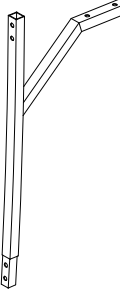
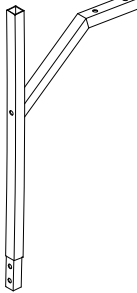

3  We recommend wearing protective gloves.

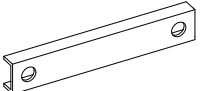
● Product accessories

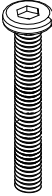
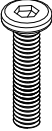

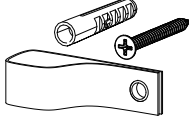
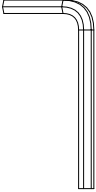
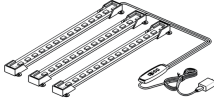
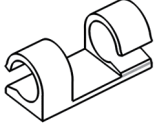

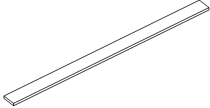
● Accessories List

<p>Ⓐ 1pcs</p> 	<p>Ⓑ 1pcs</p> 	<p>Ⓒ 1pcs</p> 	<p>Ⓓ 6pcs</p> 
<p>Ⓔ 2pcs</p> 	<p>Ⓕ 1pcs</p> 	<p>Ⓖ 1pcs</p> 	<p>Ⓗ 1pcs</p> 
<p>Ⓘ 1pcs</p> 	<p>Ⓙ 1pcs</p> 	<p>Ⓚ 1pcs</p> 	<p>Ⓛ 1pcs</p> 
<p>Ⓜ 1pcs</p> 	<p>Ⓝ 1pcs</p> 	<p>Ⓞ 1pcs</p> 	<p>Ⓟ 2pcs</p> 

<p>1 1pcs</p> 	<p>2 17pcs</p> 	<p>3 17pcs</p> 	<p>4 6pcs</p> 
<p>5 2pcs</p> 	<p>6 1pcs</p> 	<p>7 1pcs</p> 	<p>8 4pcs</p> 
<p>9 4pcs</p> 	<p>10 3pcs</p> 	<p>11 3pcs</p> 	<p>12 4pcs</p> 

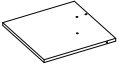

● Accessories Step

● Step 1

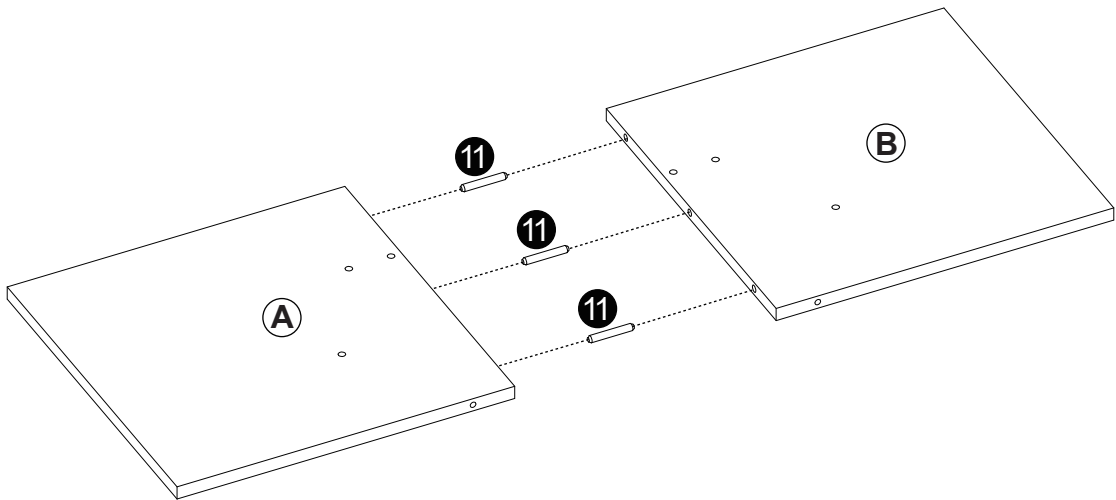
A	B	11
		
1pcs	1pcs	3pcs

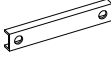

● Step 2

P	6	12
		
2pcs	1pcs	4pcs

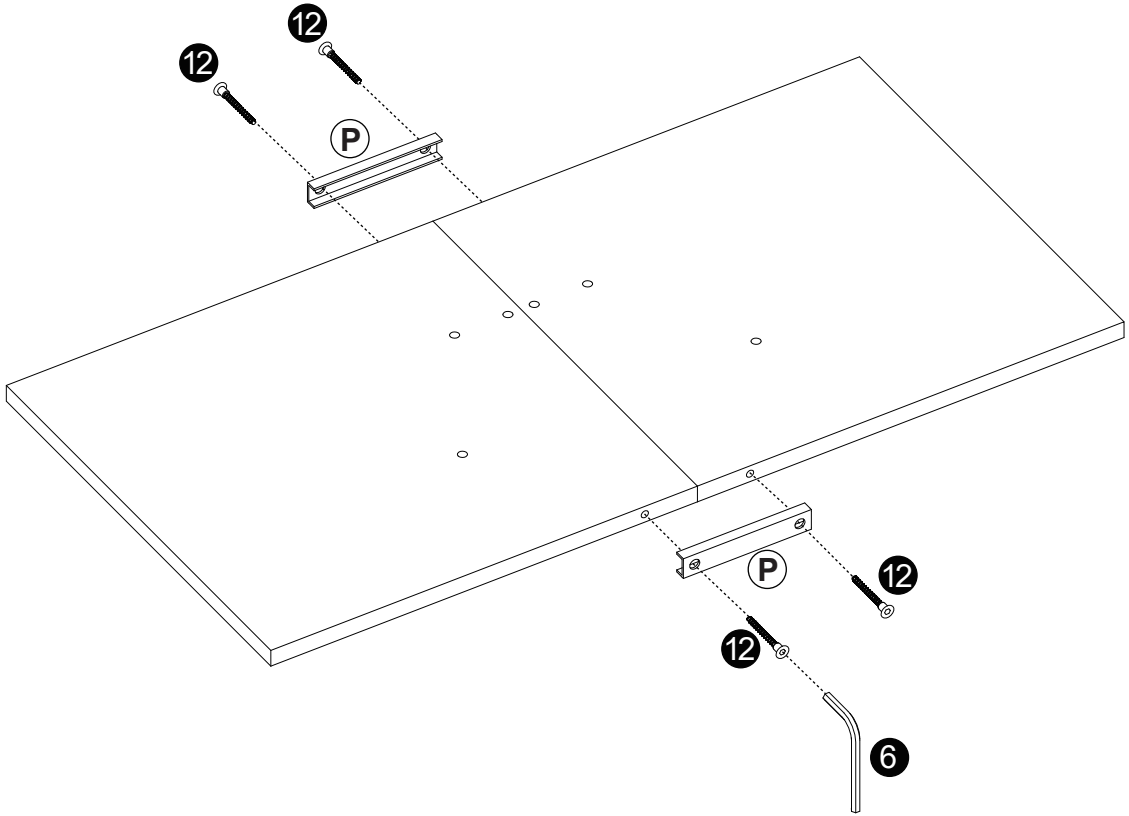

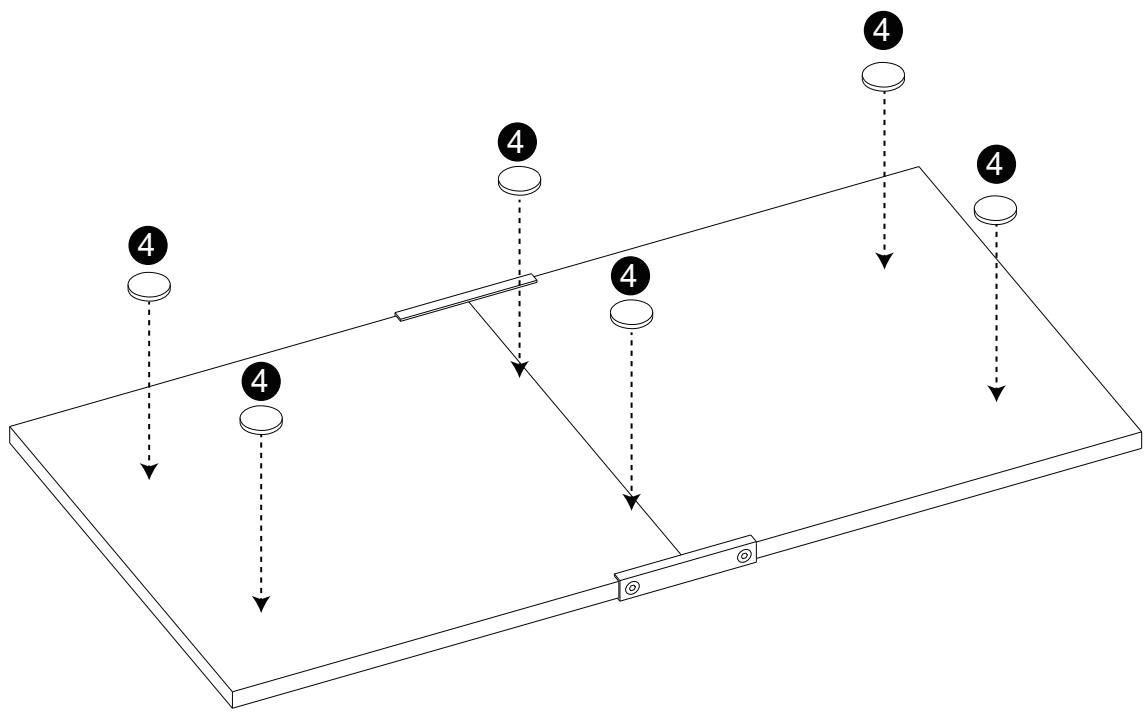

● Step 3

4

6pcs

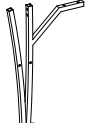

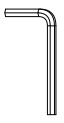

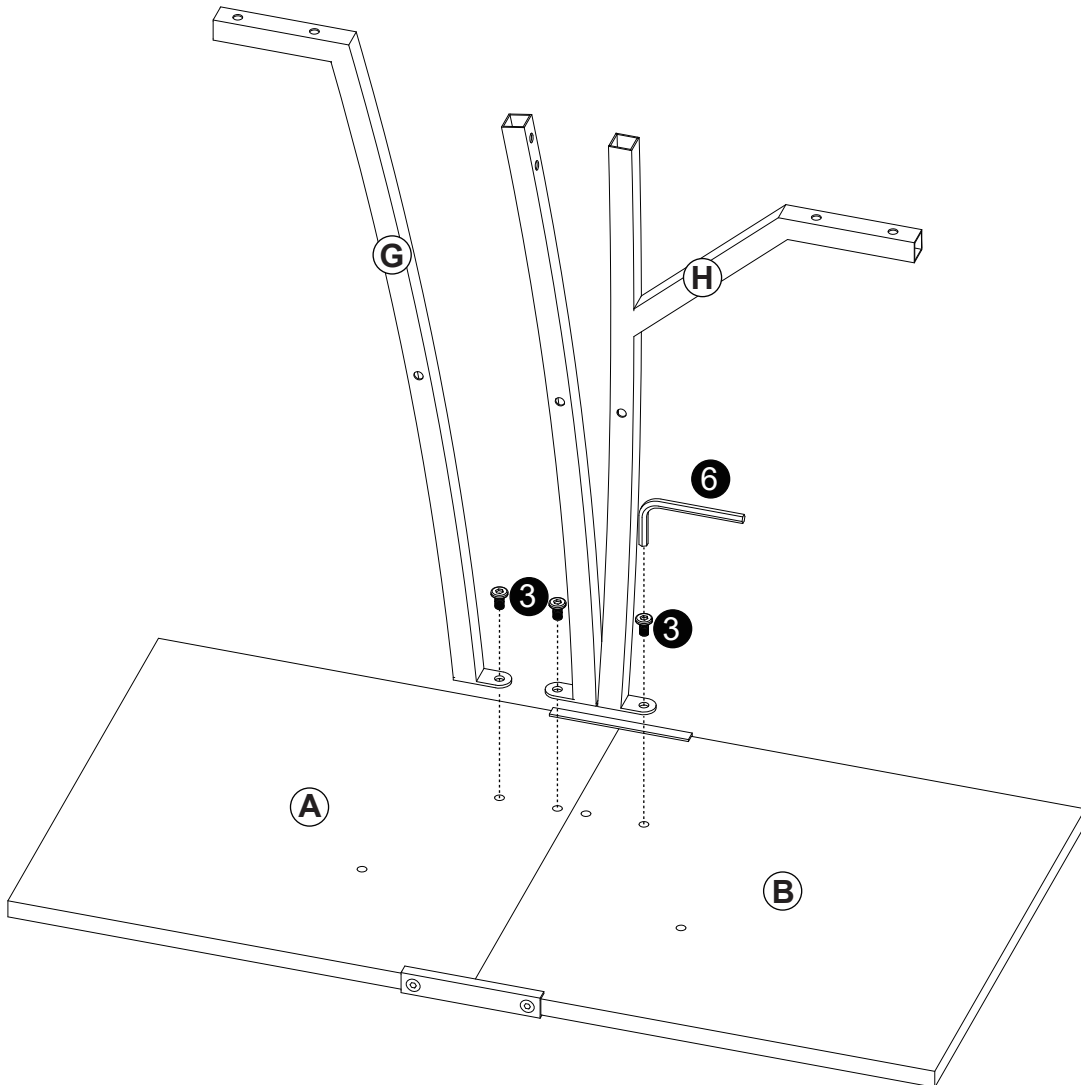
● Step 4

G	H	3	6
			
1pcs	1pcs	3pcs	1pcs



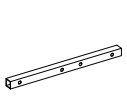

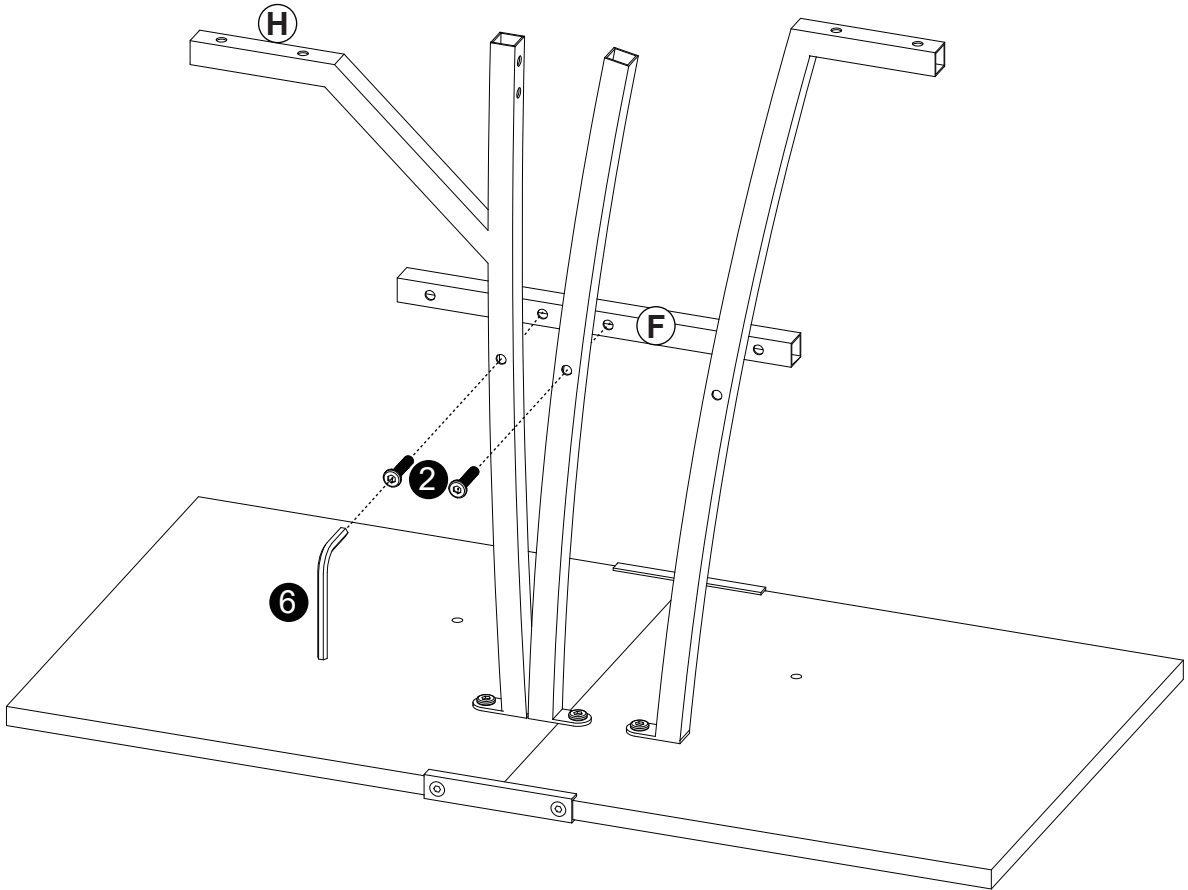

● Step 5

F	2	6
		
1pcs	2pcs	1pcs

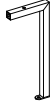
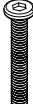

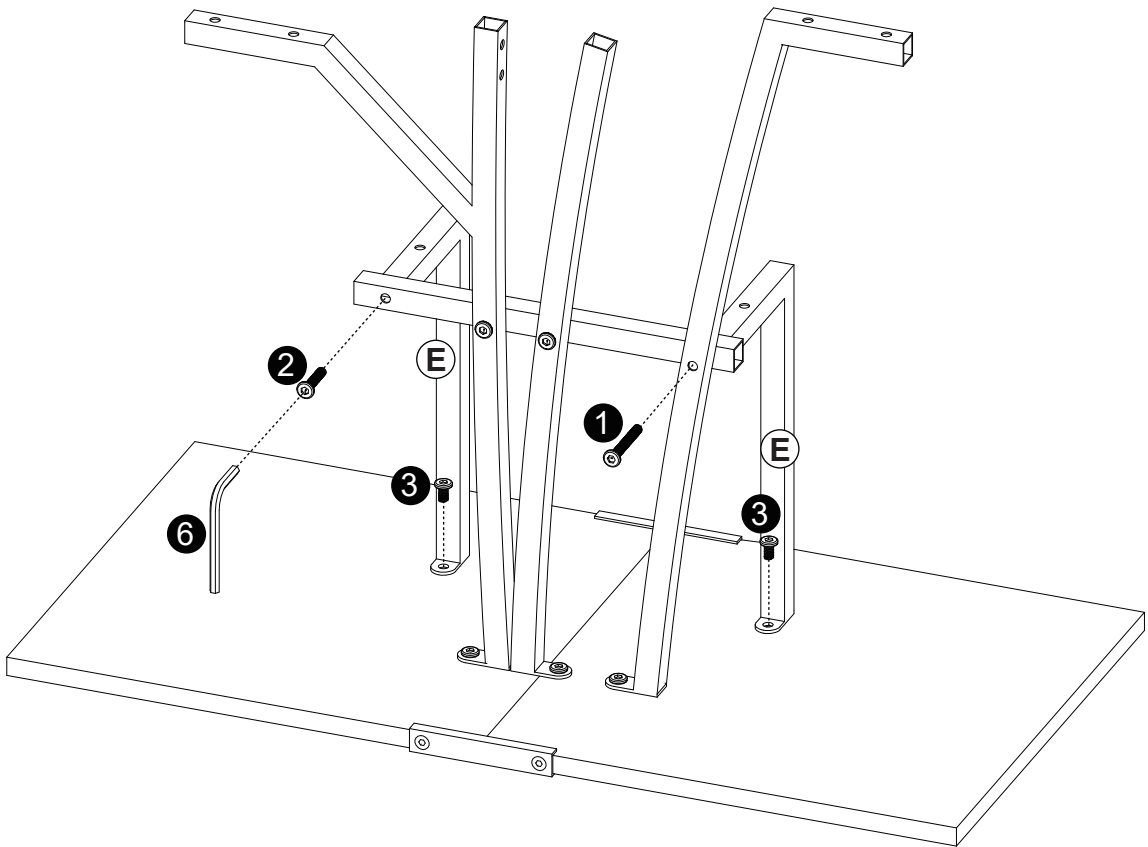

● Step 6

E	1	2	3	6
				
2pcs	1pcs	1pcs	2pcs	1pcs



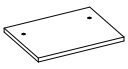

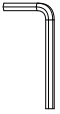
● Step 7

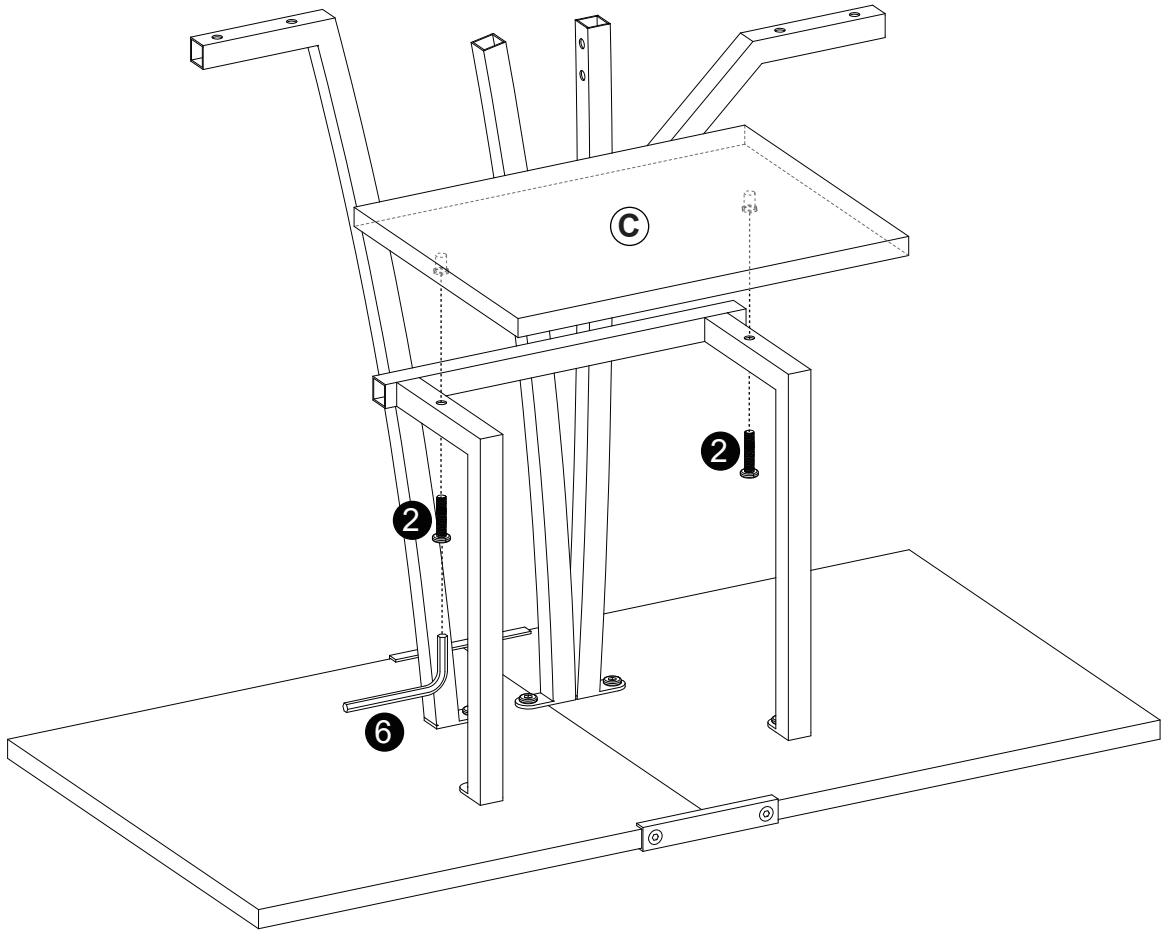
C	2	6
		
1pcs	2pcs	1pcs





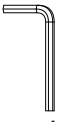

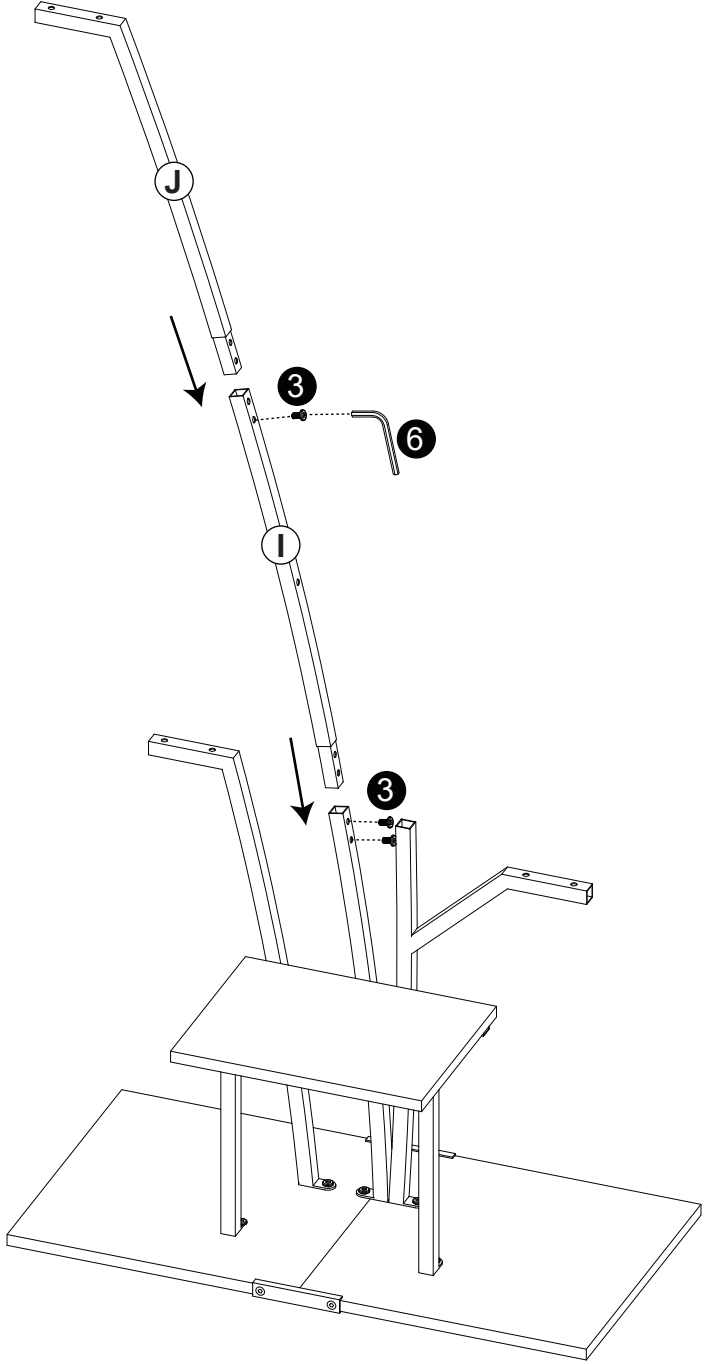
● Step 8

I	J	3	6
			
1pcs	1pcs	3pcs	1pcs

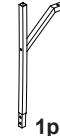

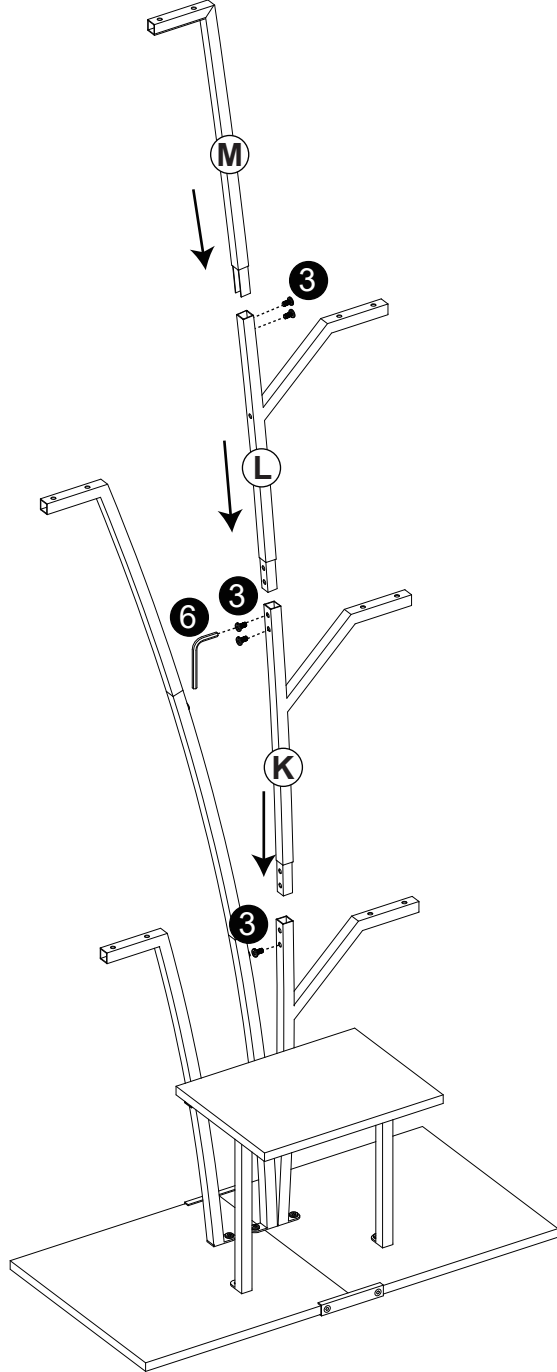

● Step 9

K	L	M	3	6
				
1pcs	1pcs	1pcs	5pcs	1pcs



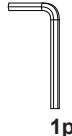

● Step 10

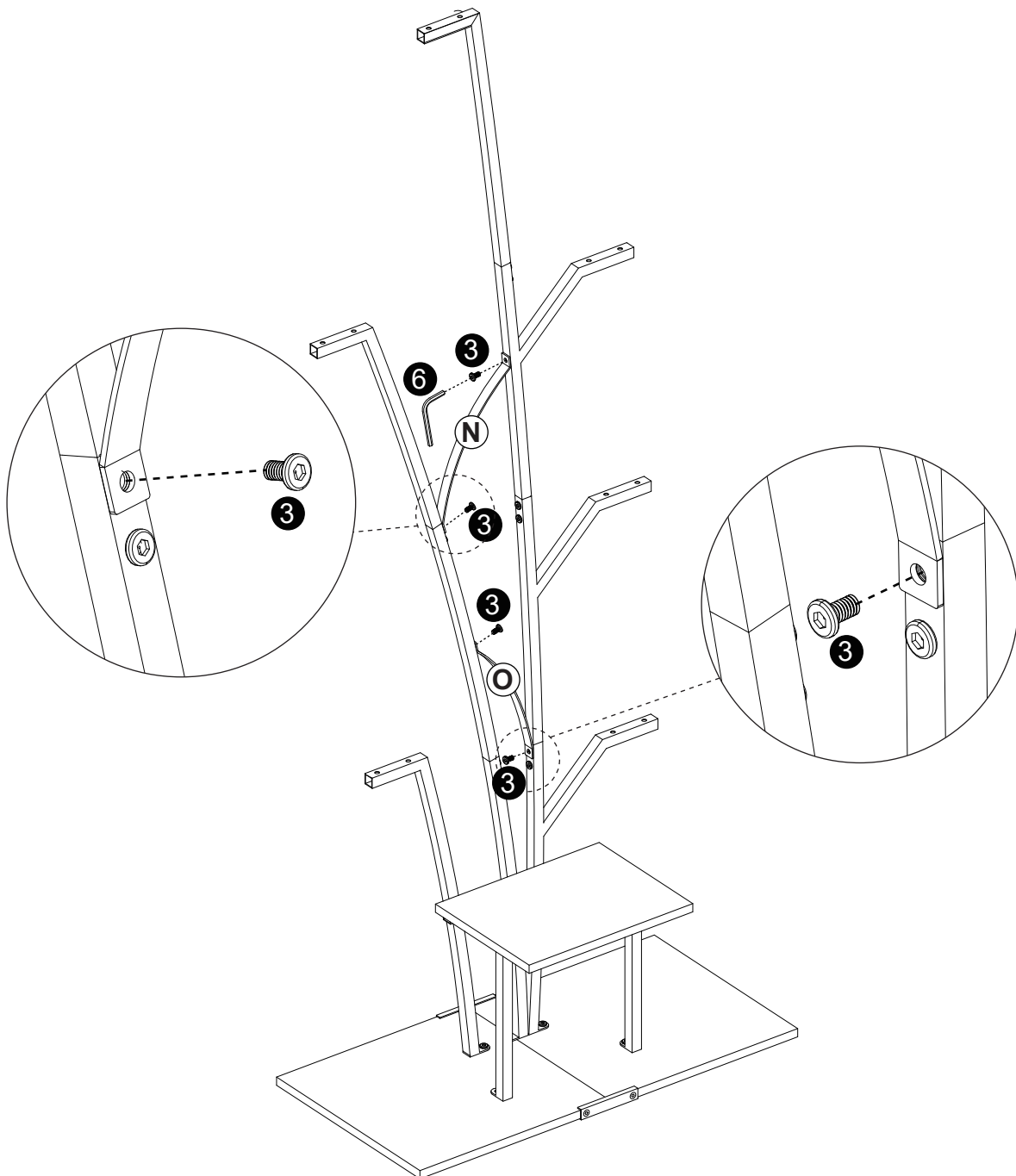
N	O	3	6
			
1pcs	1pcs	4pcs	1pcs



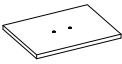

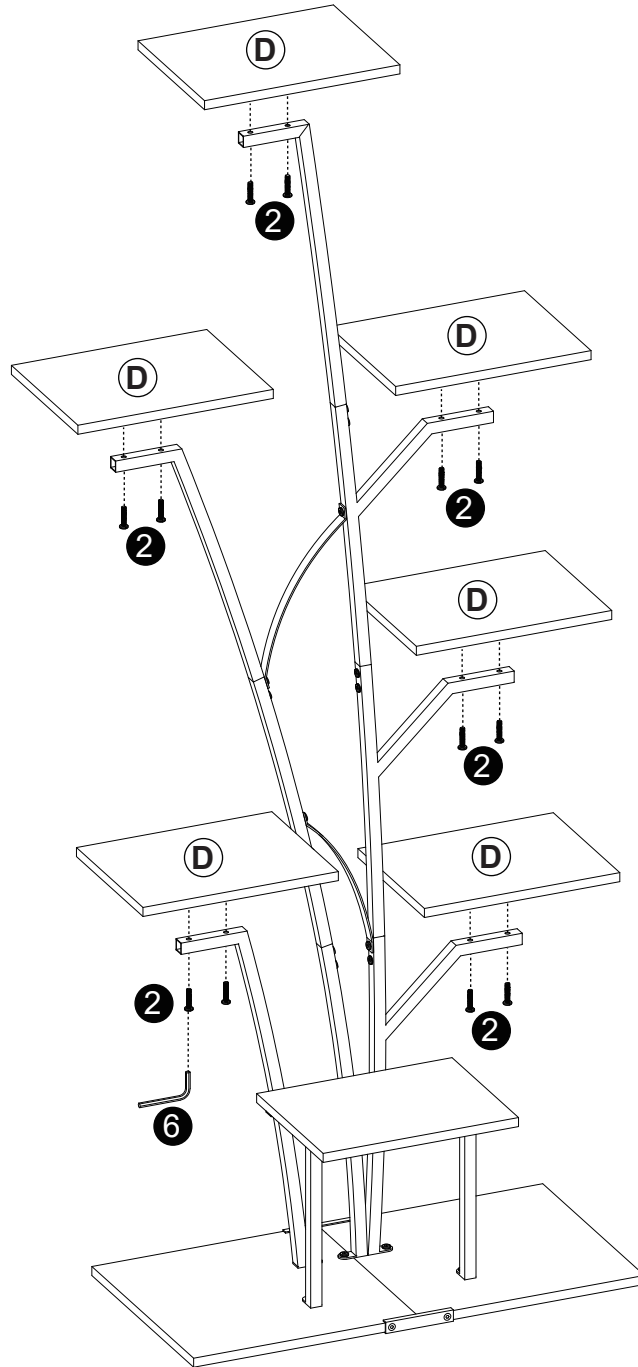

● Step 11

D	2	6
		
6pcs	12pcs	1pcs



● Step 12

7	8	9	10
			
1pcs	1pcs	4pcs	1pcs

Accessory **7** has a separate instruction manual in the box of the lamp. Please refer to the separate instruction manual of the lamp.

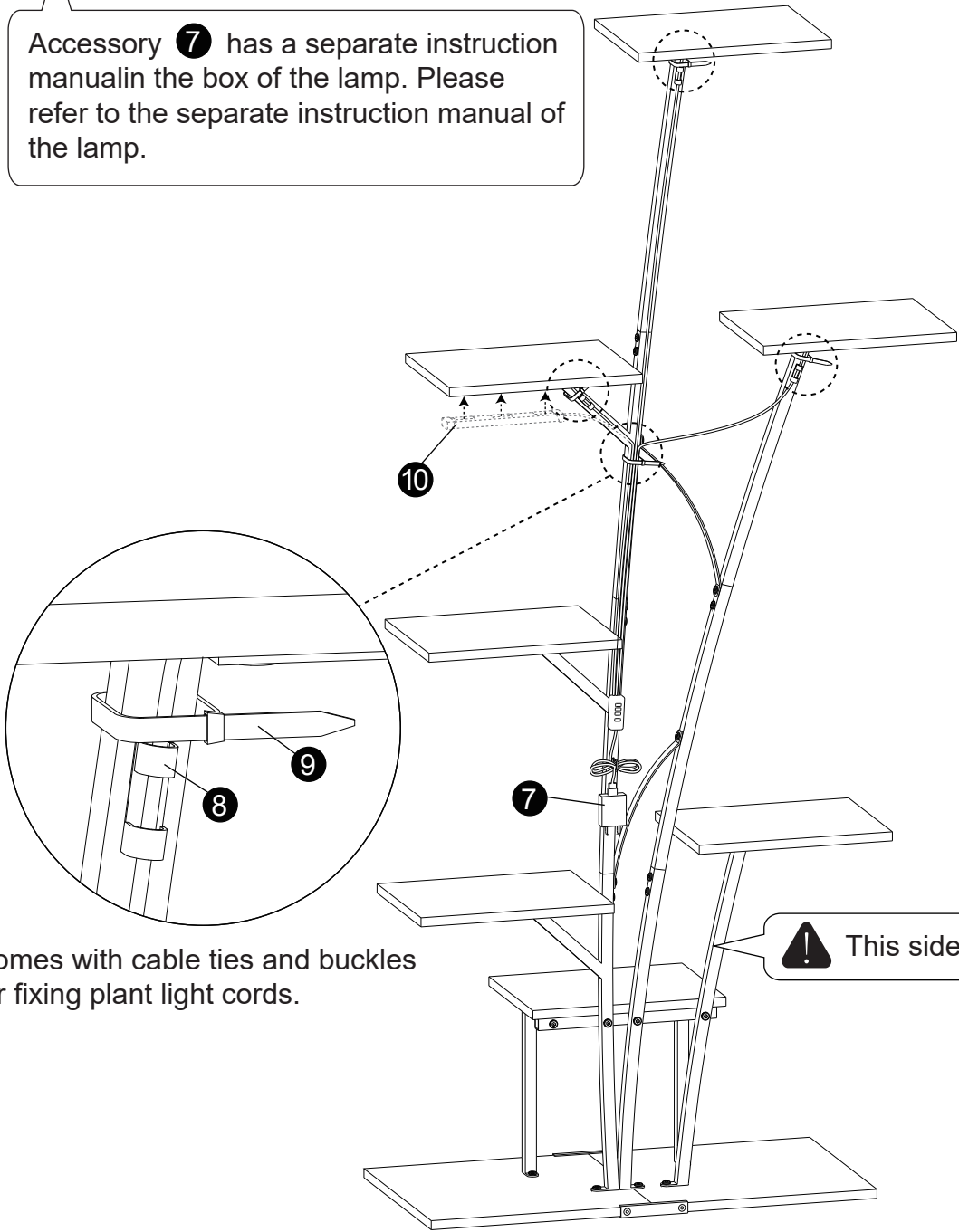

Comes with cable ties and buckles for fixing plant light cords.

● Step 13

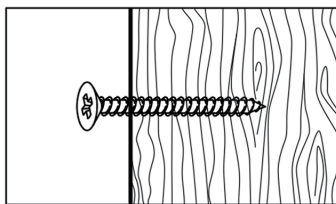
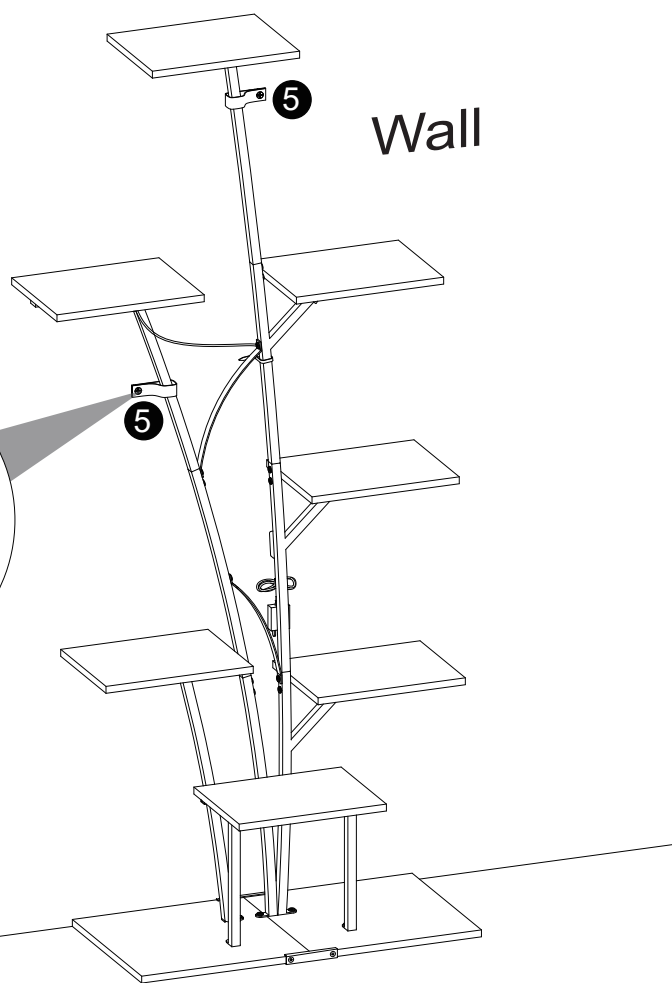
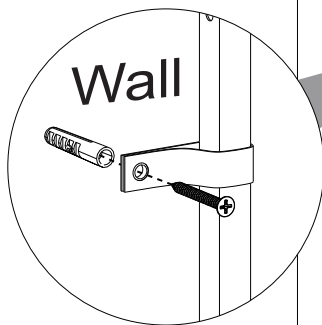
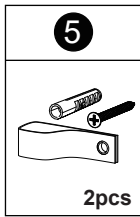

Drywall or plaster with available wood stud:

- Mark the attachment point(s) with a pencil at the appropriate height and positioned over wood stud(s).
- Drill a pilot hole(s) with a diameter that matches the screw into the wood stud(s), at the height you marked with pencil.
- Secure the screw to the wood firmly as the picture shows.

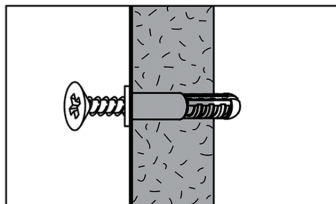

Drywall without available wood stud:

- Mark the attachment point(s) with a pencil at the appropriate height.
- Drill a hole(s) with a diameter that matches the plastic anchor through the wall at the height you marked with pencil.
- Drive the plastic plug(s) into the hole(s), using a hammer if needed.
- Insert the screw into the plastic plug firmly as the picture shows. Do not over-tighten.