

ASSEMBLY INSTRUCTIONS

DRESSER / MIRROR





Caution : Please read instructions thoroughly before unpacking assembly parts . Sharp , exposed staple tips can cause injury , therefore , for your protection , please remove any exposed staple used in packing

- 1 . We recommend that you should assemble this product with the assistance of another person ; this will make assembly easier , and will help to eliminate damage to the product or injury to persons during assembly .
- 2 . Be sure to check all packing materials carefully for small parts that may have come loose inside the carton during shipment .
- 3 . please do not over tighten screws or bolts until the assembly is complete .
- 4 . Please put all parts on a non - abrasive floor before assembly , and follow the assembly steps to assemble your newly purchased product correctly and efficiently .





PART LIST

1	DRESSER	1PC
2	MIRROR	1PC
3	MIRROR SUPPORT	2PCS

HARDWARE LIST IN-IN-MIRROR

E		BOLT $\varnothing 5/16$ "x1-3/4"	8 PCS
F		FLAT WASHER 5/16"	8 PCS
G		SPRING WASHER 5/16"	8 PCS
H		ALLEN KEY 5/16"	1 PC

ANTI-TIPPING HARDWARE PACK IN-DR

A		BRACKET	2PCS
B		TIE WRAP	1PC
C		SCREW #8x2"L	1PC
D		SCREW #8x5/8"L	1PC

STEP 1

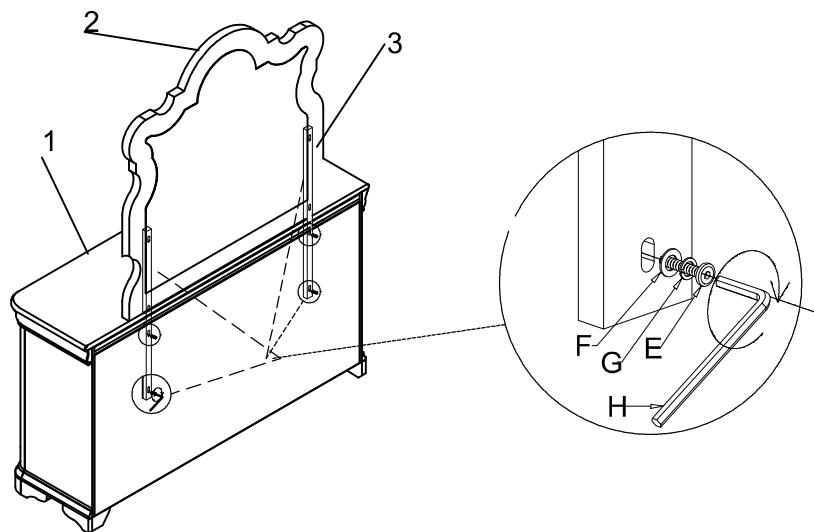

STEP 2

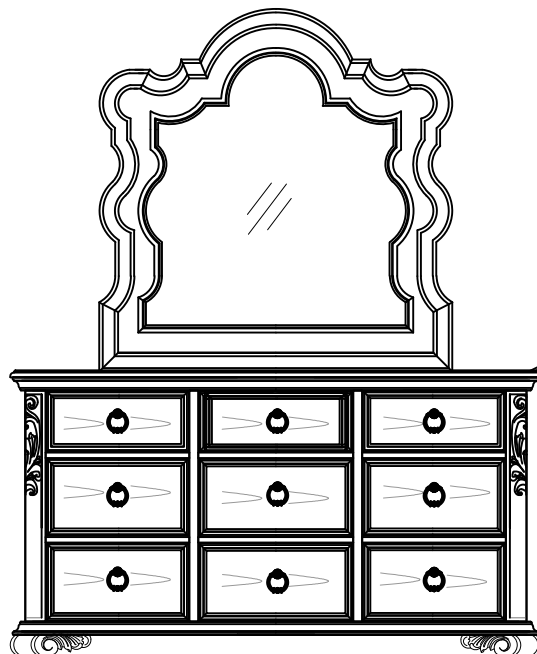

-REMOVE ANTI-TIPPING PACK FROM BACK PANEL.ASSEMBLE IT TO AVOID TIPPING

