

# Installation & Assembly

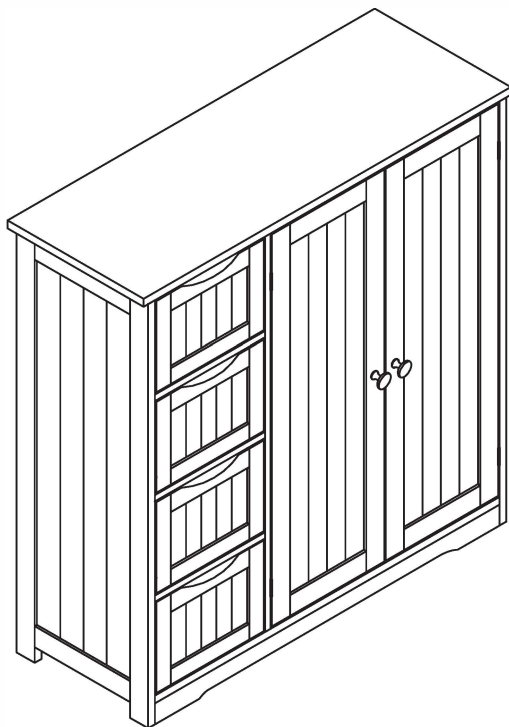

- EN** - Please read this instruction manual carefully before attempting to install.  
**DE** - Bitte lesen Sie diese Bedienungsanleitung vor der Montage gründlich durch.  
**ES** - Por favor lea con atención el manual de instrucciones antes de llevar a cabo el ensamble.  
**FR** - Lisez attentivement cette notice avant de commencer le montage.  
**IT** - Si prega di consultare il libretto delle istruzioni prima del montaggio.

# IMPORTANT/WICHTIG/ATENCIÓN

## IMPORTANT/IMPORTANTE



**EN** - We recommend **2** or more people to install.  
**DE** - Wir empfehlen, dass die Montage von **2** oder mehreren Personen durchgeführt werden sollte.  
**ES** - Recomendamos realizar el ensamble con **2** o más personas.  
**FR** - Il est recommandé d'effectuer le montage à **2** personne(s) ou plus.  
**IT** - È necessaria la presenza di **2** o più persone per il montaggio di questo prodotto.



**EN** - The expected assembly time is **1 h**.  
**DE** - Die Montagezeit beträgt durchschnittlich **1 h**.  
**ES** - El tiempo aproximado de ensamble es de **1 h**.  
**FR** - Le temps nécessaire est estimé à **1 h**.  
**IT** - Il tempo previsto per il corretto assemblaggio è di **1 h**.



**EN** - Not intended for use by children.  
**DE** - Nicht geeignet für Kinder.  
**ES** - Producto no apto para niños.  
**FR** - Produit non destiné à être utilisé par des enfants.  
**IT** - Questo prodotto non è destinato all'uso da parte dei bambini.











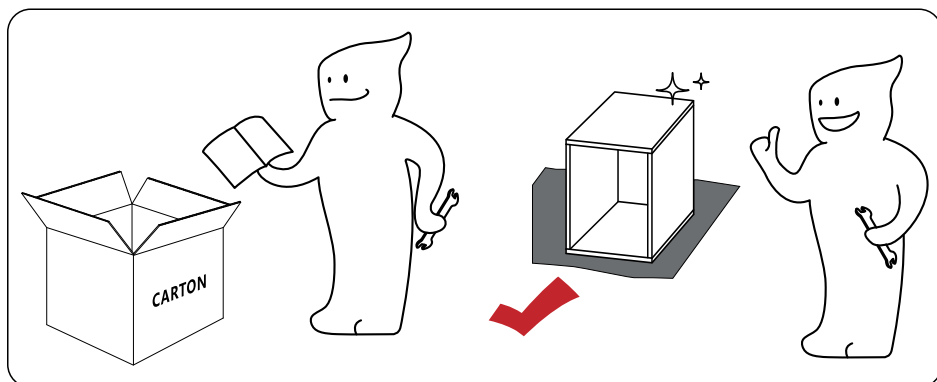
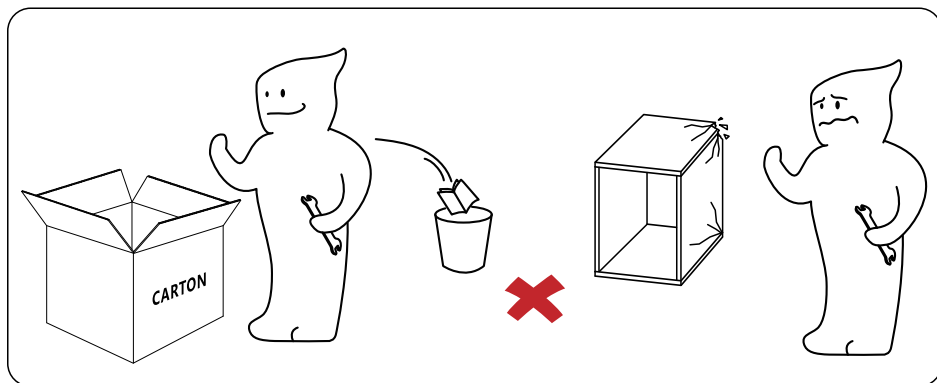

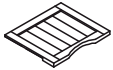
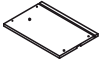
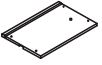
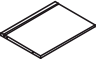

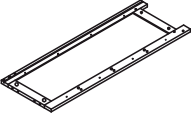
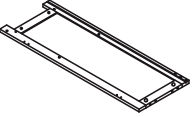
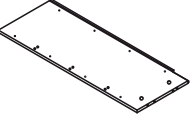
**EN** - Keep away from fire or other heat sources.  
**DE** - Bitte von Feuer und Hitzequellen fernhalten.  
**ES** - Manténgase alejado de las llamas y otras fuentes de calor.  
**FR** - Tenir à distance des flammes et autres sources de chaleur.  
**IT** - Tenere lontano dal fuoco o da altre fonti di calore.

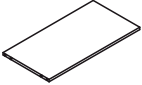
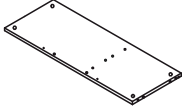
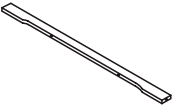

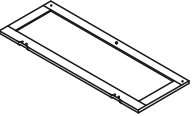

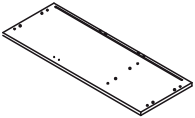
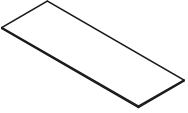
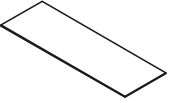
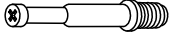













**EN** - We recommend wearing protective gloves.  
**DE** - Wir empfehlen das Tragen von Schutzhandschuhen.  
**ES** - Recomendamos el uso de guantes de seguridad.  
**FR** - Il est recommandé de porter des gants de protection.  
**IT** - Per il processo di assemblaggio, consigliamo fortemente l'utilizzo di guanti protettivi.

- EN** - Please follow the instruction manuals and use a pad to avoid damage during assembly.
- DE** - Bitte folgen Sie der Anleitung und verwenden Sie eine Unterlage, um Beschädigungen bei der Montage zu vermeiden.
- ES** - Por favor, siga las instrucciones del manual y utilice una cubierta o lona para proteger el producto y el suelo durante la instalación.
- FR** - Suivez les instructions de la notice et utilisez une couverture ou une bâche pour protéger le produit et les sols pendant le montage.
- IT** - Si prega di consultare il manuale illustrativo durante il montaggio e di utilizzare un cuscinetto per evitare possibili danni.



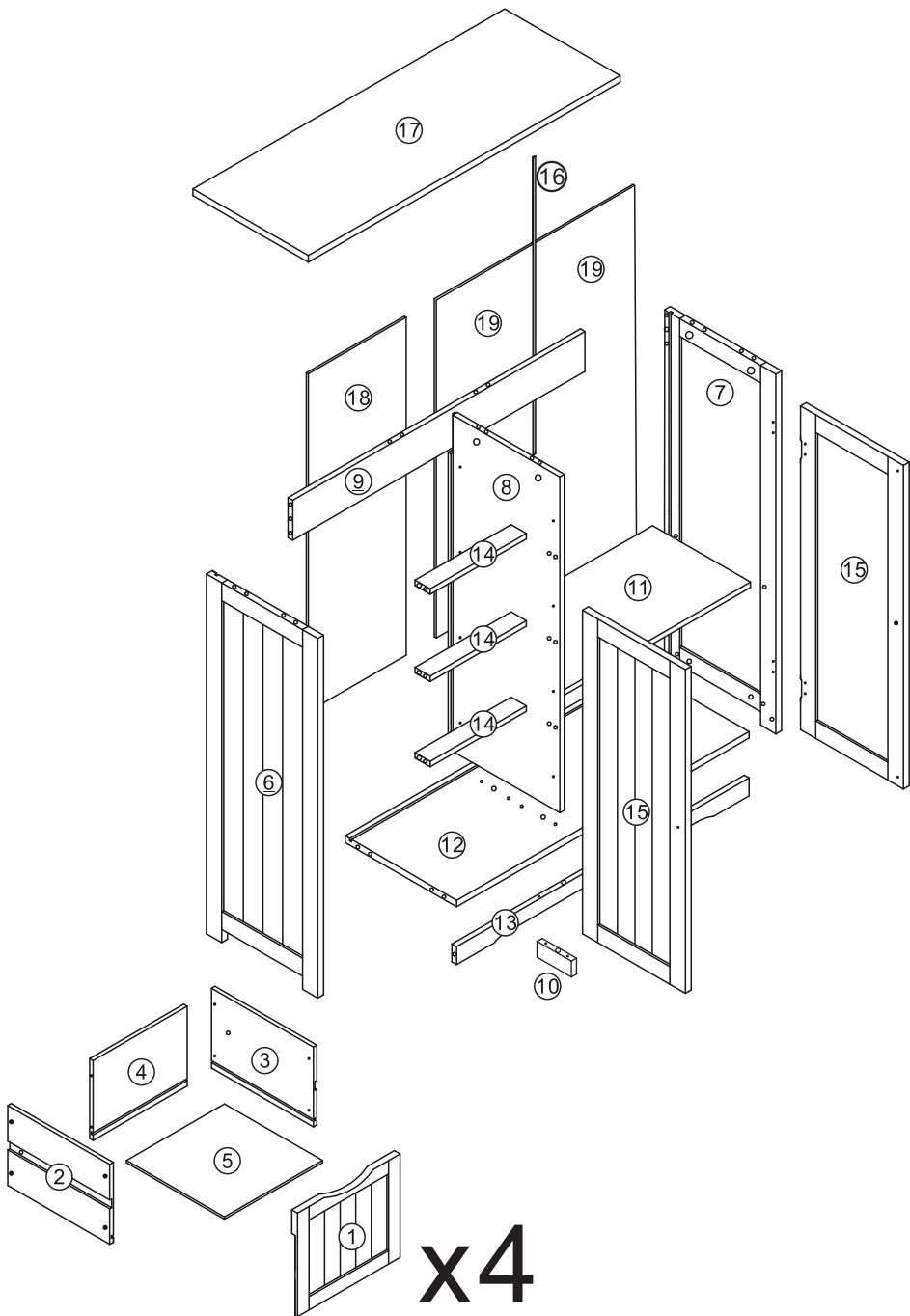

① × 4 	② × 4 L 	③ × 4 R 	④ × 4 
⑤ × 4 	⑥ × 1 L 	⑦ × 1 R 	⑧ × 1 
⑨ × 1 	⑩ × 1 	⑪ × 1 	⑫ × 1 
⑬ × 1 	⑭ × 3 	⑮ × 2 	⑯ × 1 
⑰ × 1 	⑱ × 1 	⑲ × 2 	Ⓐ × 28 
Ⓑ × 28 	Ⓒ × 27 	Ⓓ × 2 	Ⓔ × 6 

<p>Ⓕ × 38</p>  <p>12mm</p>	<p>Ⓖ × 8</p>  <p>14mm</p>	<p>Ⓗ × 2</p> 	<p>Ⓘ × 1</p> 
<p>Ⓙ × 2</p>  <p>14mm</p>	<p>Ⓚ × 8</p> 	<p>Ⓛ × 4</p> 	<p>Ⓜ × 8</p> 
<p>Ⓝ × 8</p> 	<p>Ⓞ × 1</p> 	<p>Ⓟ × 2</p> 	<p>Ⓠ × 2</p>  <p>12mm</p>
<p>Ⓡ × 4</p> 	<p>Ⓢ × 2</p> 	<p>Ⓣ × 32</p>  <p>25mm</p>	<p>Ⓤ × 2</p> 
<p>Ⓥ × 2</p> 			





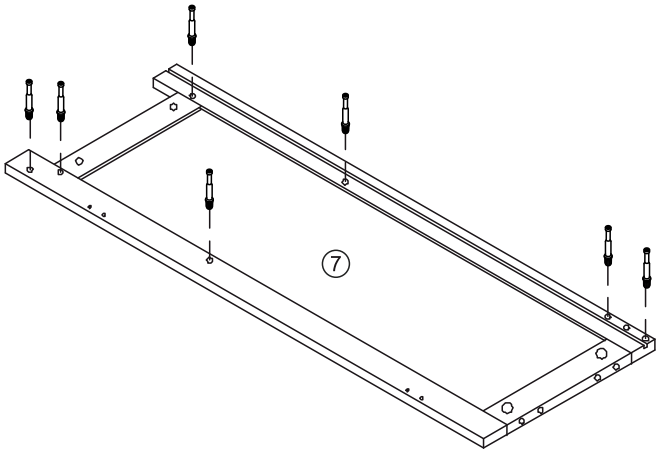
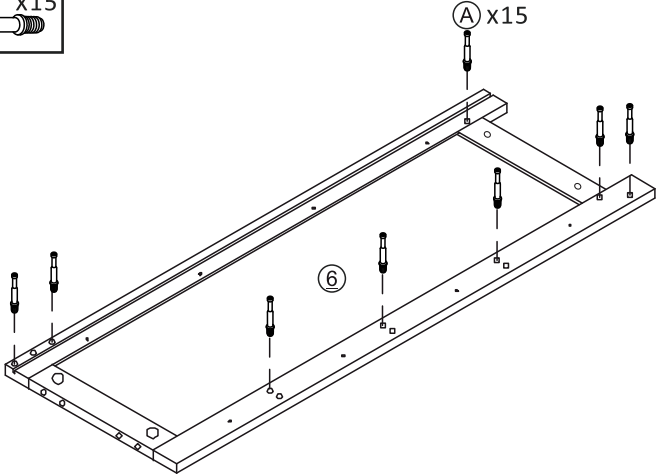

x4

1

⑥		x1
⑦		x1
Ⓐ		x15



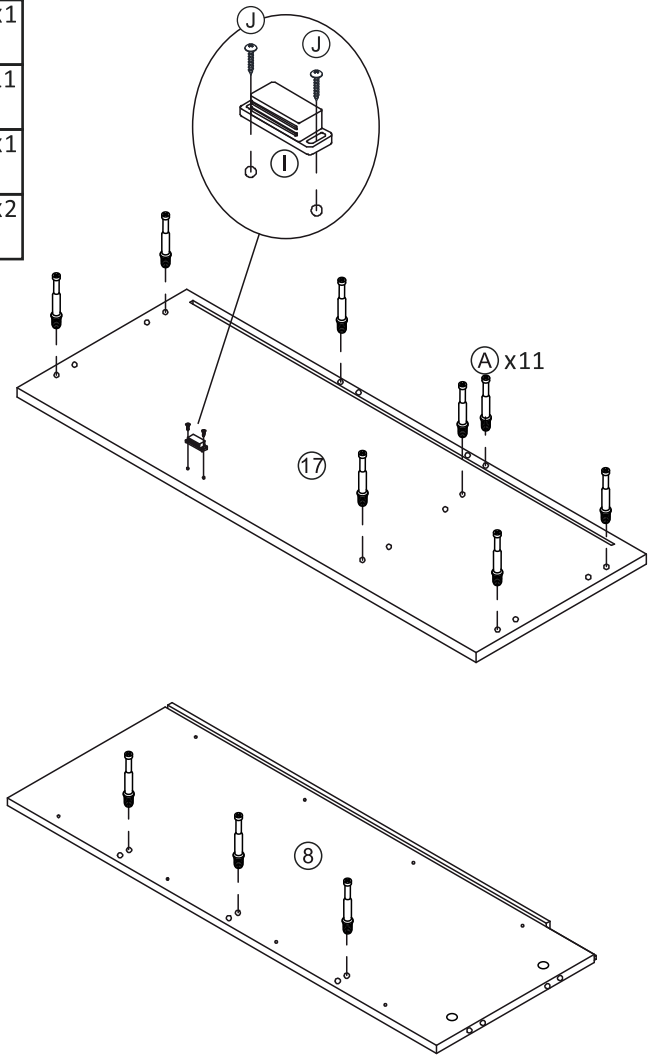

2

⑧		x1
⑰		x1
Ⓐ		x11
Ⓘ		x1
Ⓙ		x2



3



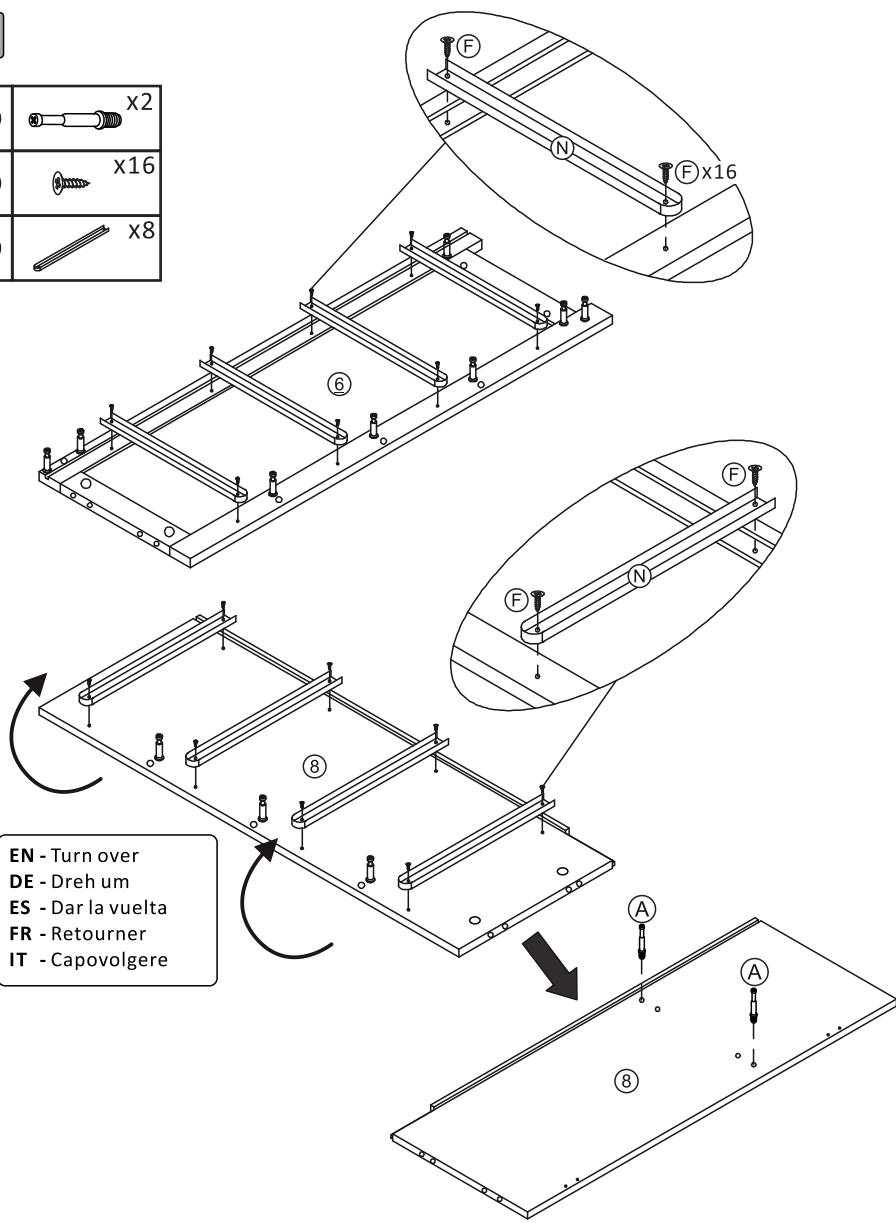

(A)		x2
(F)		x16
(N)		x8



EN - Turn over  
DE - Dreh um  
ES - Dar la vuelta  
FR - Retourner  
IT - Capovolgere

EN - Please pay attention to the direction of Part (N) when installing.  
DE - Bitte bei der Montage die Richtung von Teil (N) beachten.  
ES - Por favor preste atención a la dirección de la pieza (N) al instalar.  
FR - Veuillez à bien respecter l'orientation de l'élément (N) lors du montage.  
IT - Si prega di fare attenzione al verso della parte (N) durante il montaggio.



4

(12)		X1
(13)		X1
(C)		X2
(E)		X2

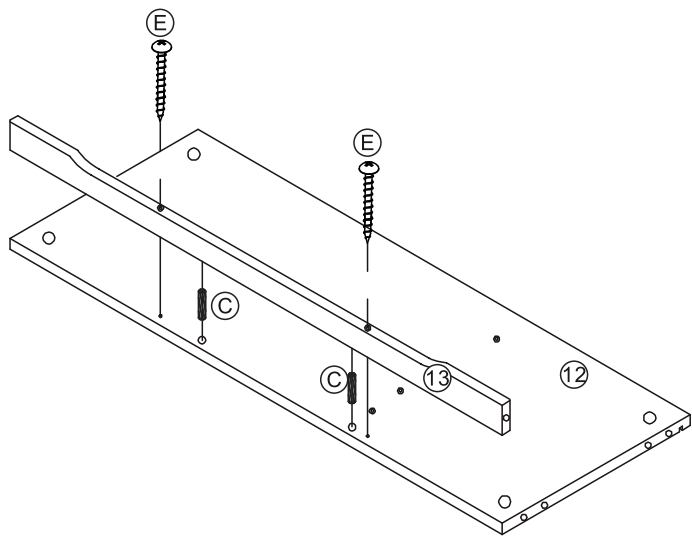
**EN** - Please pay attention to the direction of Part (13) when installing.  
**DE** - Bitte bei der Montage die Richtung von Teil (13) beachten.  
**ES** - Por favor preste atención a la dirección de la pieza (13) al instalar.  
**FR** - Veuillez à bien respecter l'orientation de l'élément (13) lors du montage.  
**IT** - Si prega di fare attenzione al verso della parte (13) durante il montaggio.



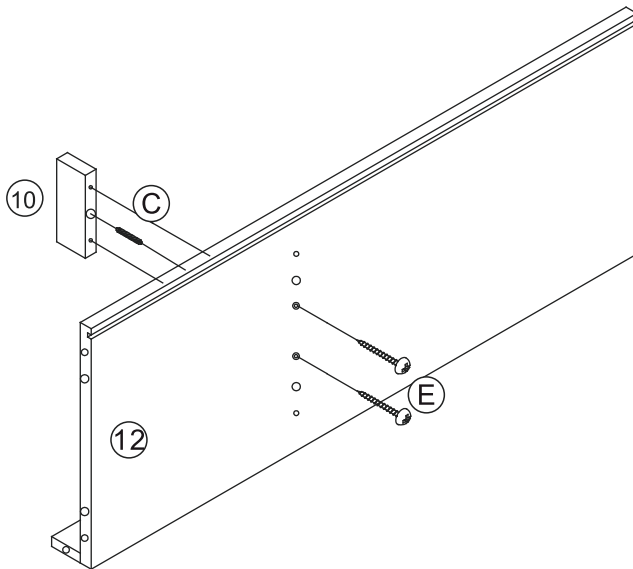

5

(10)		X1
(C)		X1
(E)		X2



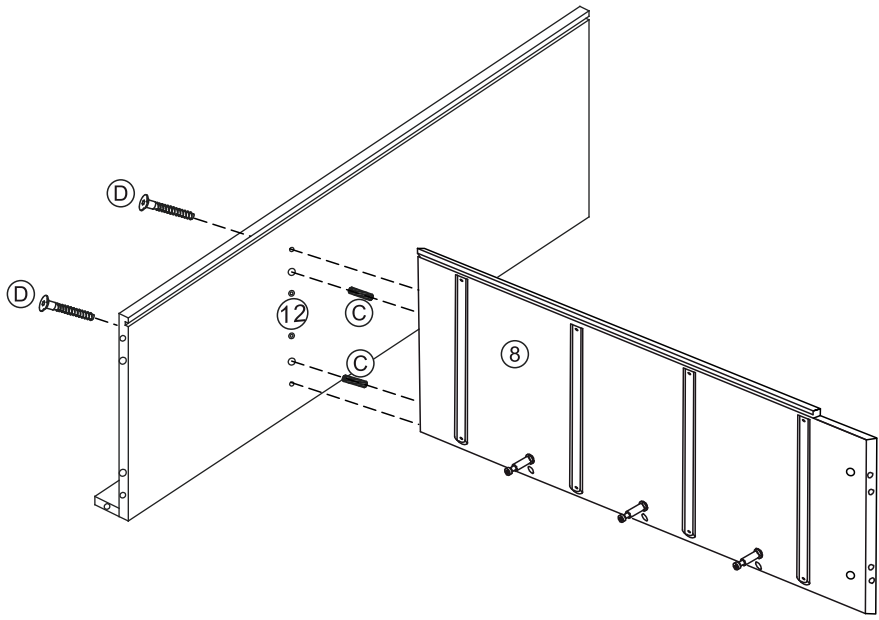

# 6

(C)		x2
(D)		x2



**EN** - Please pay attention to the direction of Part (8) when installing.  
**DE** - Bitte bei der Montage die Richtung von Teil (8) beachten.  
**ES** - Por favor preste atención a la dirección de la pieza (8) al instalar.  
**FR** - Veuillez à bien respecter l'orientation de l'élément (8) lors du montage.  
**IT** - Si prega di fare attenzione al verso della parte (8) durante il montaggio.

7

(14)		x3
(B)		x3
(C)		x3

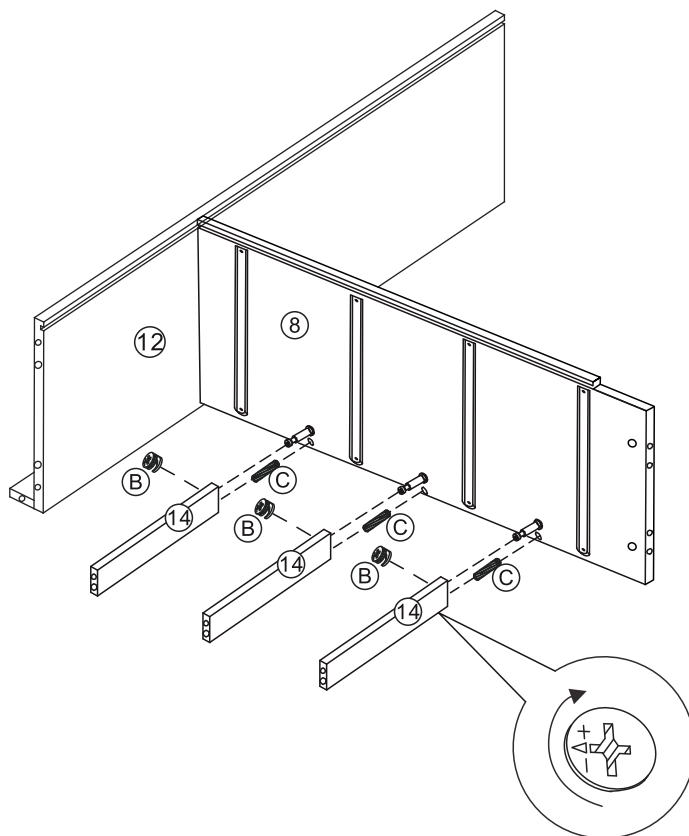

**EN** - Please pay attention to the direction of Part (14) when installing.



**DE** - Bitte bei der Montage die Richtung von Teil (14) beachten.

**ES** - Por favor preste atención a la dirección de la pieza (14) al instalar.

**FR** - Veuillez à bien respecter l'orientation de l'élément (14) lors du montage.



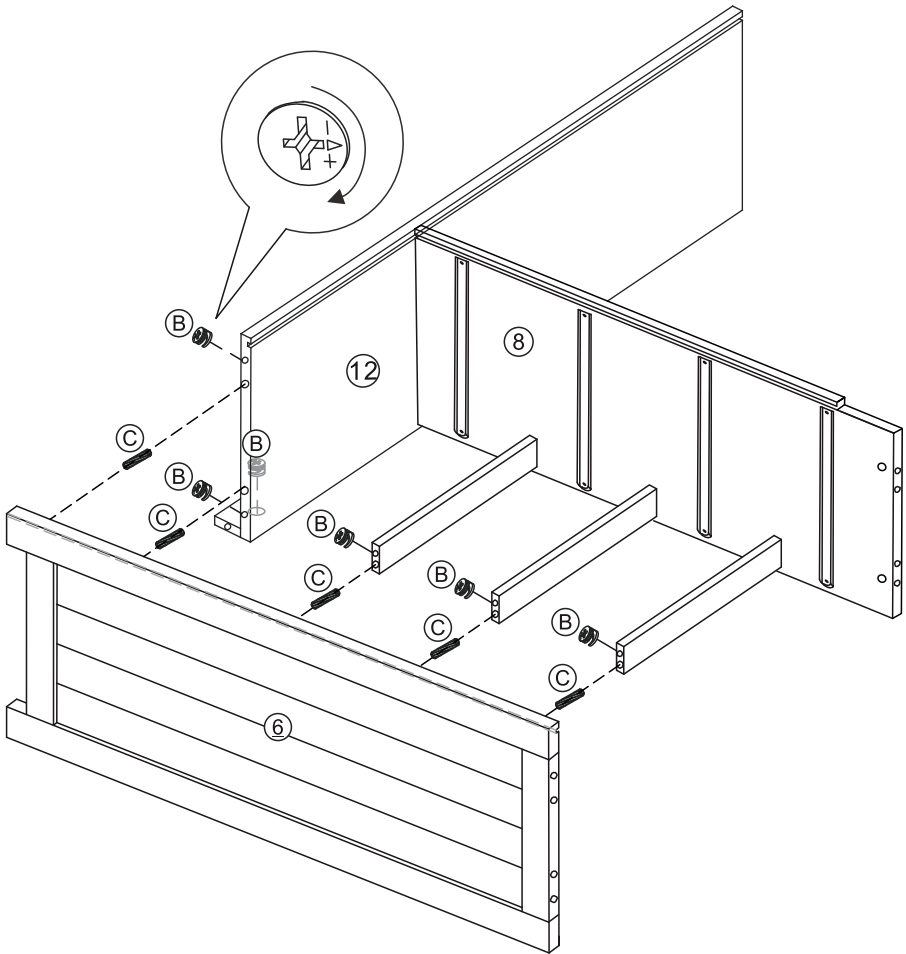

**IT** - Si prega di fare attenzione al verso della parte (14) durante il montaggio.

8

(B)		x6
(C)		x5



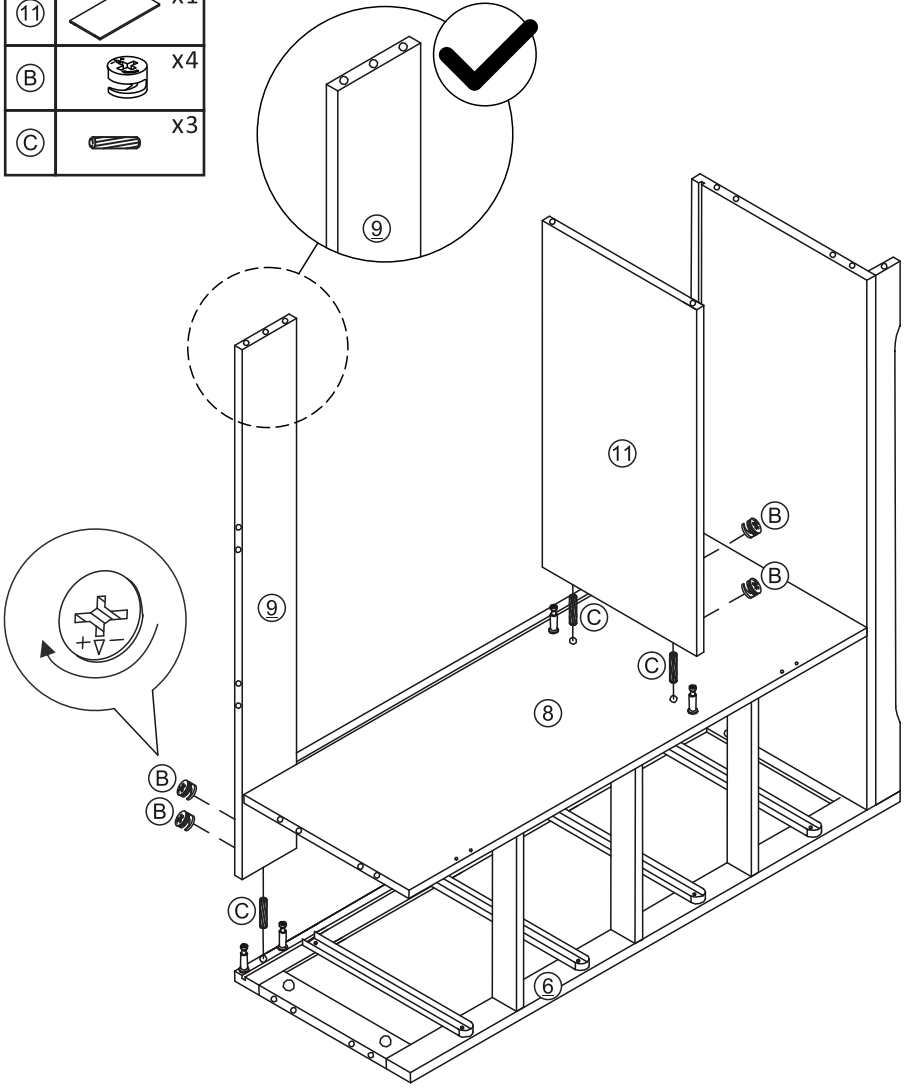

9

⑨		x1
⑪		x1
Ⓑ		x4
Ⓒ		x3





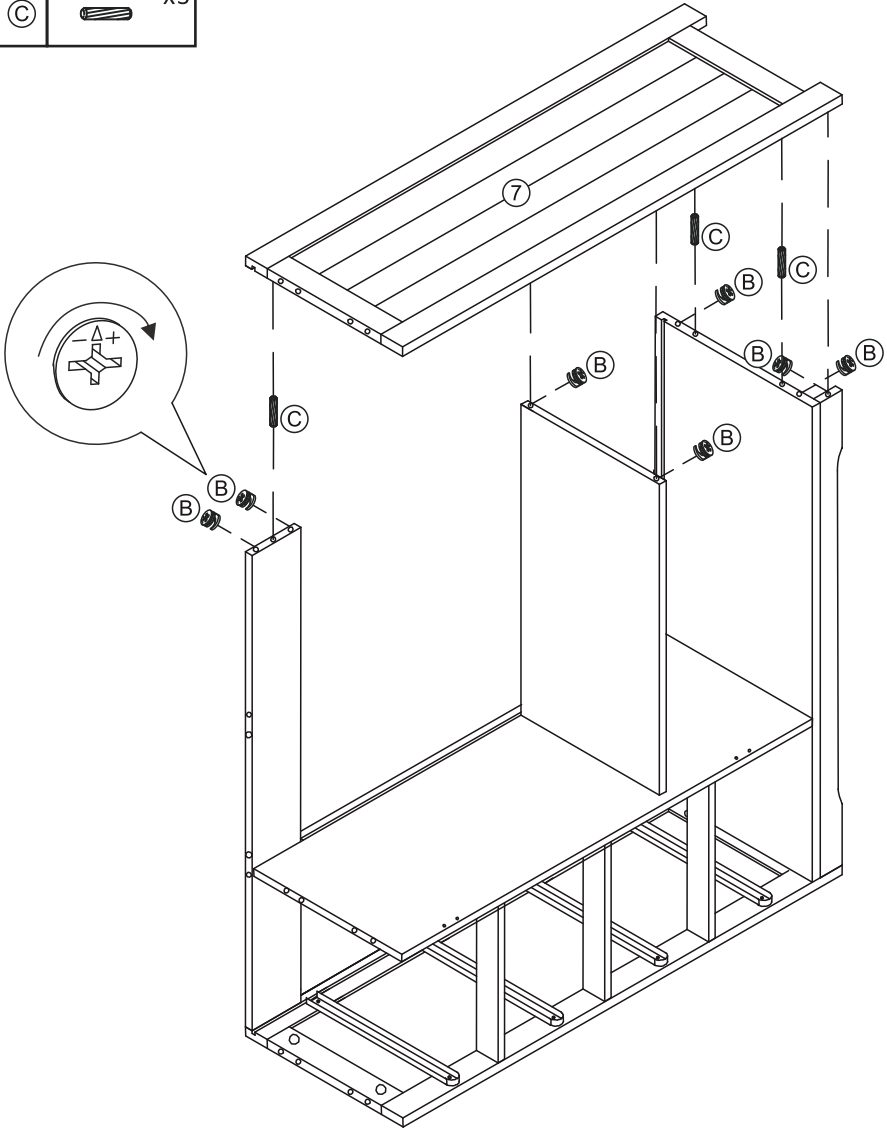

10

(B)		x7
(C)		x3



**11**

①⑥		x1
①⑧		x1
①⑨		x2
Ⓒ		x8

①⑧	big	<input type="text"/>
①⑨	short	<input type="text"/>

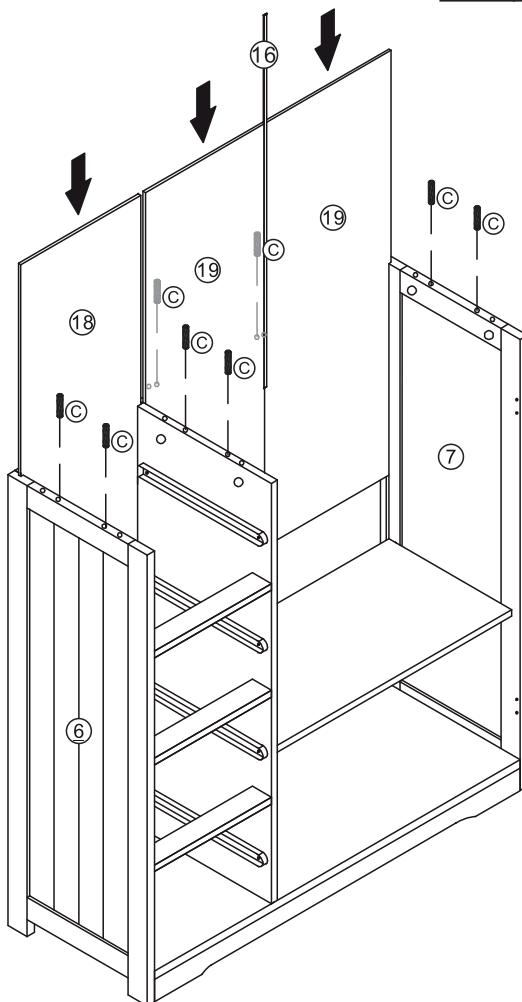

**EN** - Please pay attention to the direction of Part (18&19) when installing.  
**DE** - Bitte bei der Montage die Richtung von Teil (18&19) beachten.  
**ES** - Por favor preste atención a la dirección de la pieza (18&19) al instalar.  
**FR** - Veuillez à bien respecter l'orientation de l'élément (18&19) lors du montage.  
**IT** - Si prega di fare attenzione al verso della parte (18&19) durante il montaggio.



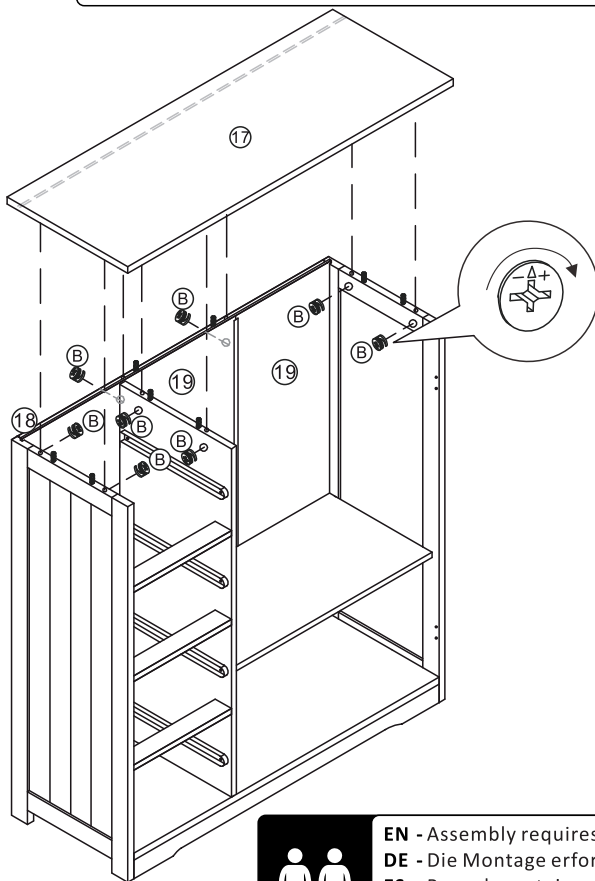

**12**

- EN** - Align Back Panel (#18&19) to fit into the groove of Top Panel (#17). Misalignment may block the top panel from seating properly.
- DE** - Richten Sie die Rückwand (Nr. 18&19) so aus, dass sie passgenau in die Nut der oberen Platte (Nr. 17) eingesetzt wird. Wird die Rückwand nicht richtig ausgerichtet, liegt die obere Platte nicht sauber auf.
- ES** - Alinee el panel posterior (nº 18&19) de modo que encaje en la ranura del panel superior (nº 17). Una alineación incorrecta podría impedir la correcta colocación del panel superior.
- FR** - Alignez le panneau arrière (nº 18&19) pour qu'il s'insère dans la rainure du panneau supérieur (nº 17). Un mauvais alignement pourrait empêcher le panneau supérieur de se positionner correctement.
- IT** - Allinea il pannello posteriore (#18&19) in modo che si inserisca correttamente nella scanalatura del pannello superiore (#17). Un allineamento errato potrebbe impedire il corretto inserimento del pannello superiore.





- EN** - Assembly requires 2 adults.
- DE** - Die Montage erfordert 2 Erwachsene.
- ES** - Para el montaje se necesitan 2 adultos.
- FR** - L'assemblage nécessite 2 adultes.
- IT** - Il montaggio richiede 2 adulti.

# 13

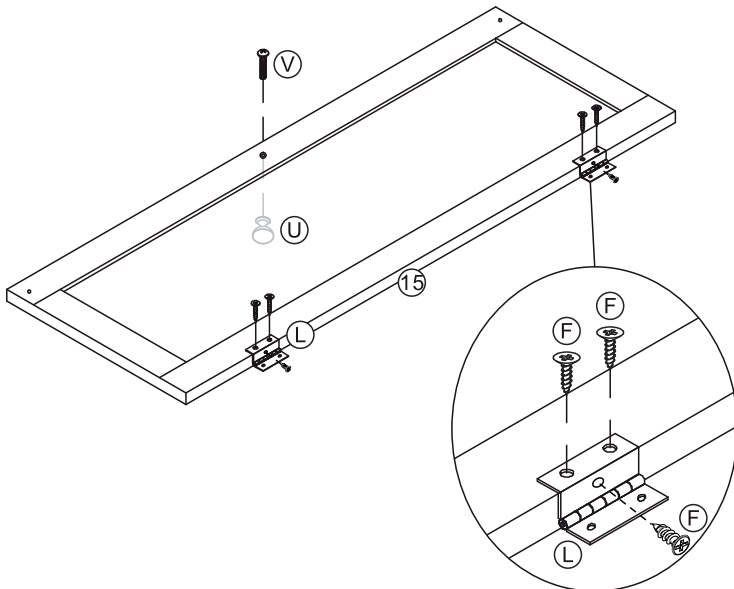
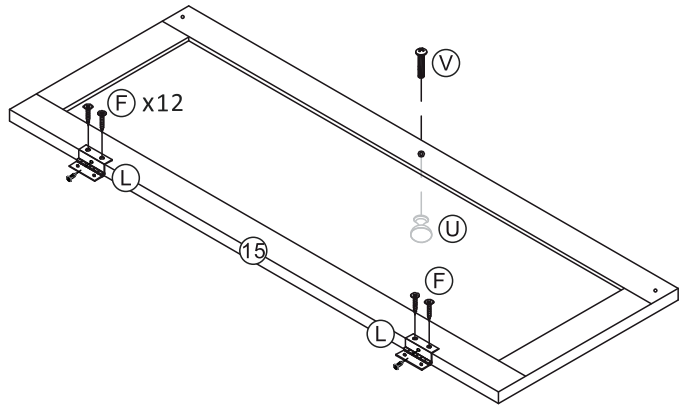
(15)		x2
(F)		x12
(L)		x4
(U)		x2
(V)		x2



14





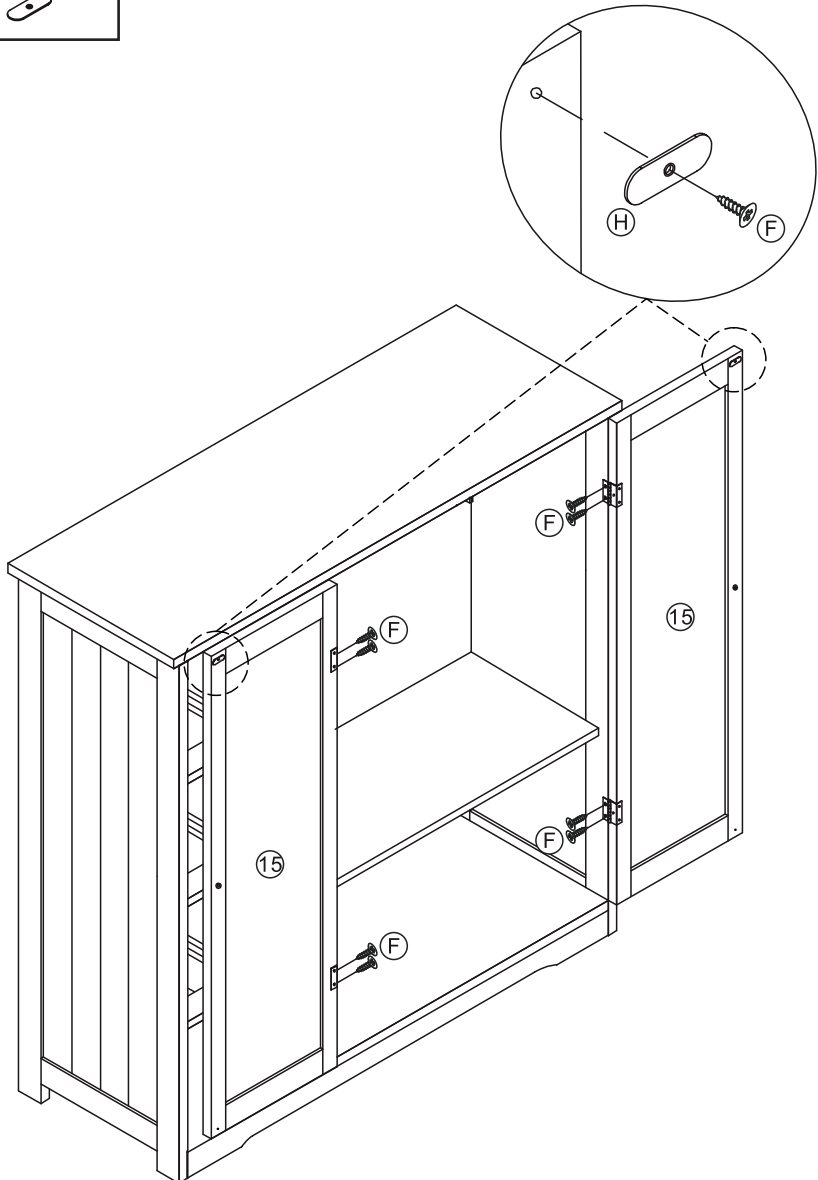

(F)	 x10
(H)	 x2



EN - Assembly requires 2 adults.  
DE - Die Montage erfordert 2 Erwachsene.  
ES - Para el montaje se necesitan 2 adultos.  
FR - L'assemblage nécessite 2 adultes.  
IT - Il montaggio richiede 2 adulti.



15



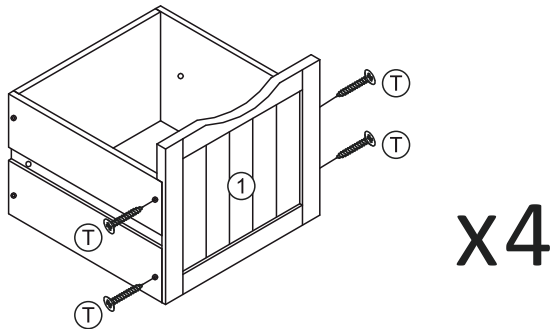
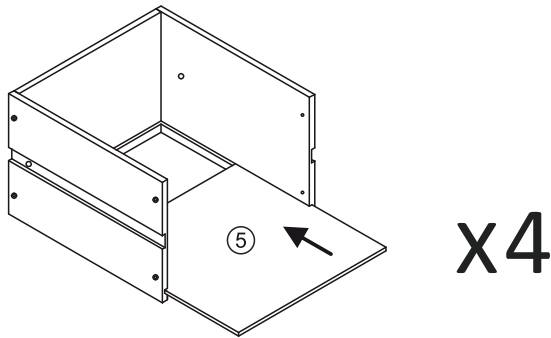
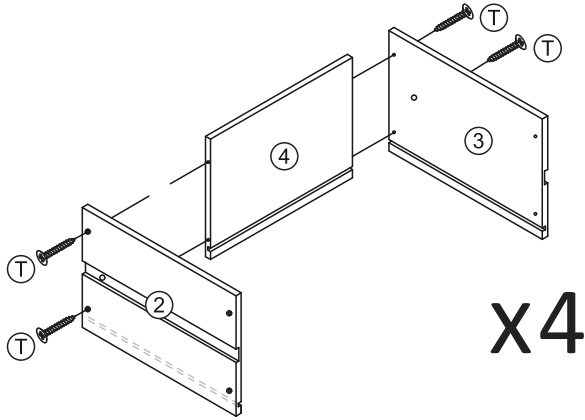

①		x4
②		x4
③		x4
④		x4
⑤		x4
Ⓣ		x32

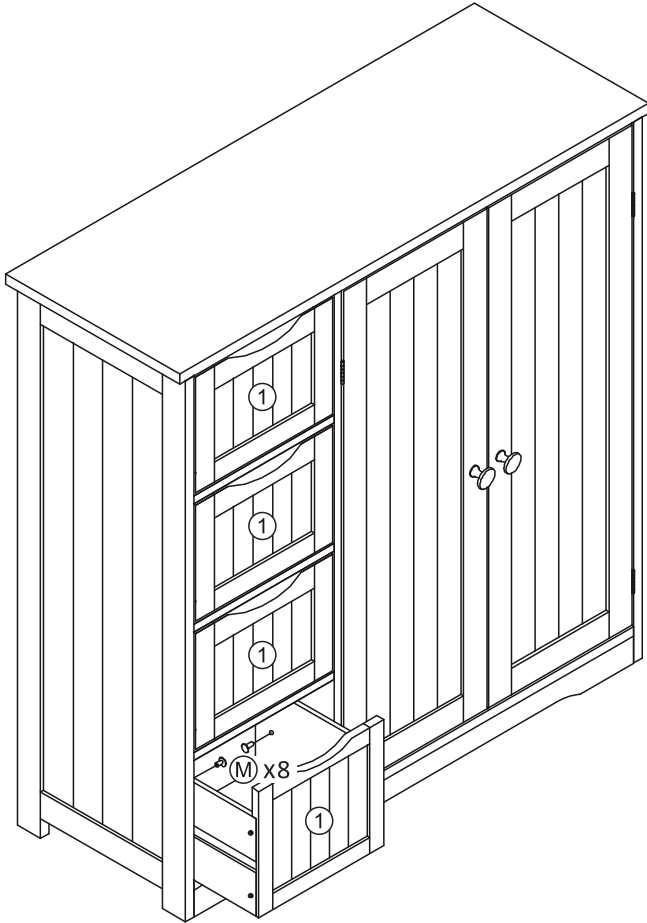

16



17

(G)		x8
(K)		x8
(Q)		x2
(R)		x2

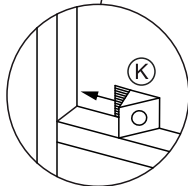
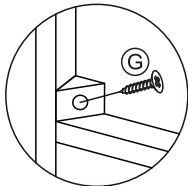
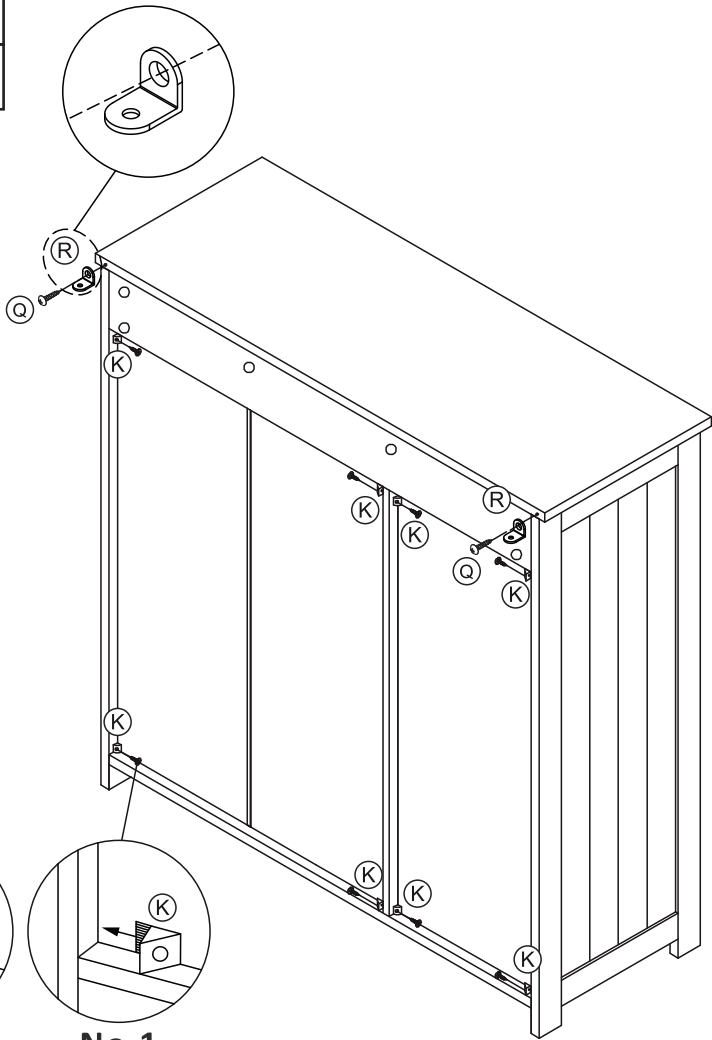

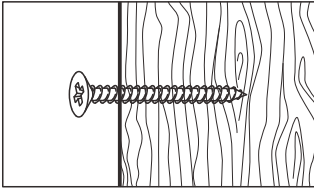

**Drywall or plaster with available wood stud:**

- Mark the attachment point(s) with a pencil at the appropriate height and positioned over wood stud(s).
- Drill a pilot hole(s) with a diameter that matches the screw into the wood stud(s), at the height you marked with pencil.
- Secure the screw to the wood firmly as the picture shows.

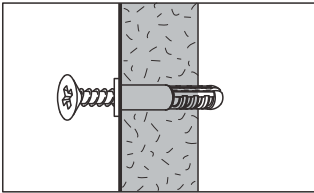

**Drywall without available wood stud:**

- Mark the attachment point(s) with a pencil at the appropriate height.
- Drill a hole(s) with a diameter that matches the plastic anchor through the wall at the height you marked with pencil.
- Drive the plastic plug(s) into the hole(s), using a hammer if needed.
- Insert the screw into the plastic plug firmly as the picture shows. Do not over-tighten.

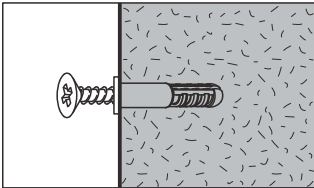

**Masonry:**

- Mark the attachment point(s) with a pencil at the appropriate height.
- Drill a hole(s) with a diameter and depth that match the plastic anchor through the wall at the height you marked with pencil.
- Drive the plastic plug(s) into the hole(s), using a hammer if needed.
- Insert the screw into the plastic plug firmly as the picture shows. Do not over-tighten.

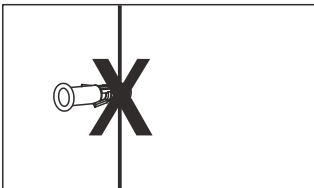

**If the screw can't be secured to the wall, please keep the product away from children.**

**If your wall material is not listed here, or if you have any questions, consult your local hardware store.**

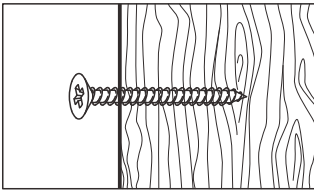

#### Trockenbau mit zugänglicher Holzstruktur:

- Markieren Sie den (die) Befestigungspunkt (e) mit einem Bleistift in der entsprechenden Höhe und über dem (den) Holzständer(n).
- Bohren Sie ein Vorbohrloch bzw. Vorbohrlöcher mit einem zur Schraube passenden Durchmesser in der von Ihnen mit Bleistift markierten Höhe in den/die Holzpfosten.
- Befestigen Sie die Schraube fest im Holz, wie auf dem Bild gezeigt.

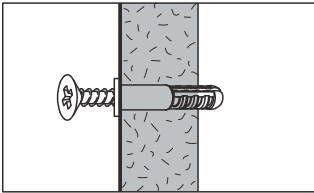

#### Trockenbauwand mit Hohlraum:

- Markieren Sie den (die) Befestigungspunkt(e) mit einem Bleistift in der entsprechenden Höhe.
- Bohren Sie ein Vorbohrloch bzw. Vorbohrlöcher mit einem zum Dübel passenden Durchmesser in der von Ihnen mit Bleistift markierten Höhe in die Trockenbauwand.
- Drücken Sie den/die Kunststoffdübel in das/die Loch/Löcher, wenn nötig mit leichten Hammerschlägen.
- Drehen Sie die Schraube fest in den Kunststoffdübel ein, wie in der Abbildung gezeigt. Nicht zu fest anziehen.

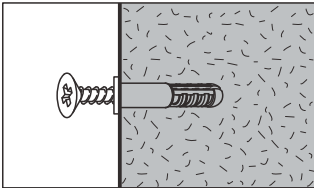

#### Mauerwerk:

- Markieren Sie den (die) Befestigungspunkt(e) mit einem Bleistift in der entsprechenden Höhe.
- Bohren Sie ein Vorbohrloch bzw. Vorbohrlöcher mit einem zum Dübel passenden Durchmesser in der von Ihnen mit Bleistift markierten Höhe in das Mauerwerk.
- Drücken Sie den/die Kunststoffdübel in das/die Loch/Löcher, wenn nötig mit Hammerschlägen.
- Drehen Sie die Schraube fest in den Kunststoffdübel ein, wie in der Abbildung gezeigt. Nicht zu fest anziehen.

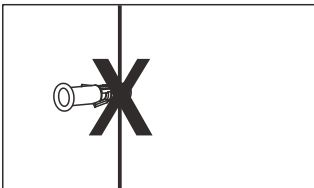

Bitte das Produkt von Kindern fernhalten.

Wenn die Schraube nicht an der Wand befestigt werden kann, oder Ihr Wandmaterial hier nicht aufgeführt ist oder wenn Sie Fragen haben, wenden Sie sich an Ihren örtlichen Eisenwarenhändler.

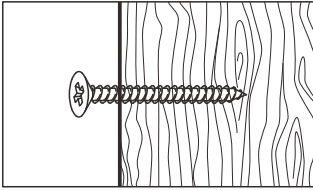

**Paneles o muros de yeso donde se pueda usar tornillos para madera:**

- Marque los puntos de fijación con un lápiz a la altura adecuada donde pondrá los tornillos.
- A la altura marcada con el lápiz, taladre un orificio piloto que coincida con el tamaño del tornillo.
- Asegure el tornillo a la madera firmemente como se muestra en la foto.

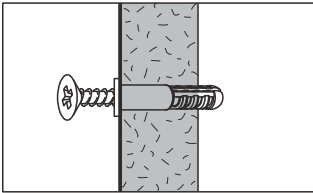

**Paneles o muros de yeso donde no se pueda usar tornillos para madera:**

- Marque los puntos de fijación con un lápiz a la altura adecuada donde pondrá los tornillos.
- A la altura marcada con el lápiz, taladre un agujero que coincida con el diámetro del taquete.
- Inserte el taquete en el agujero. Use un martillo si fuera necesario.
- Inserte el tornillo firmemente como se muestra en la imagen. No apriete demasiado.

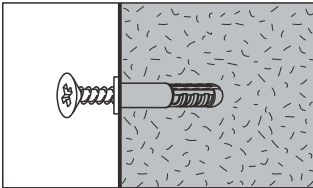

**Mampostería:**

- Marque los puntos de fijación con un lápiz a la altura adecuada donde pondrá los tornillos.
- A la altura marcada con el lápiz, taladre un agujero que coincida con el diámetro del taquete.
- Inserte el taquete en el agujero. Use un martillo si fuera necesario.
- Inserte el tornillo firmemente como se muestra en la imagen. No apriete demasiado.

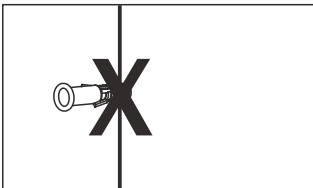

Si el tornillo no se puede fijar a la pared, mantenga el producto alejado de los niños.

Si el material de su pared no figura aquí, o si tiene alguna pregunta, consulte con su ferretería local.

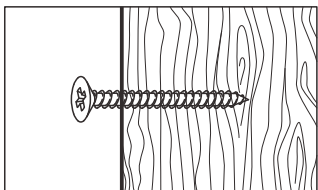

#### Cloison sèche ou plâtre avec du bois:

- Marquez le/les repère(s) de fixation au crayon à la hauteur qui convient sur le/les montants de bois.
- Percez un/des avant-trou(s) d'un diamètre correspondant à celui de la vis sur le repère.
- Fixez fermement la vis dans le bois comme sur le dessin.

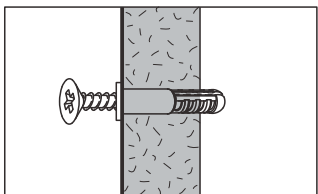

#### Cloison sèche (sans bois):

- Marquez le/les repère(s) de fixation au crayon à la hauteur qui convient.
- Percez un/des trou(s) d'un diamètre correspondant à celui de la cheville en plastique sur le repère.
- Introduisez la/les cheville(s) en plastique dans le/les trou(s), au besoin avec un marteau.
- Insérez la vis dans la cheville fermement, comme sur le dessin. Ne vissez pas trop loin.

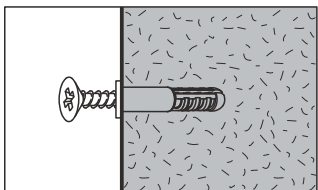

#### Mur plein (béton, pierre...):

- Marquez le/les repère(s) de fixation au crayon à la hauteur qui convient.
- Percez un/des trou(s) d'un diamètre et d'une profondeur correspondant à la cheville en plastique sur le repère.
- Introduisez la/les cheville(s) en plastique dans le/les trou(s), au besoin avec un marteau.
- Insérez la vis dans la cheville fermement, comme sur le dessin. Ne vissez pas trop loin.

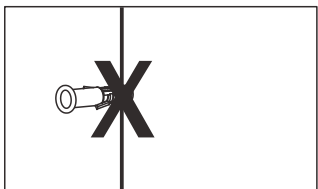

S'il n'est pas possible de fixer le meuble au mur avec une vis, tenir le produit éloigné des enfants.

Si le matériau de votre mur n'est pas listé ici ou si vous avez des questions, renseignez-vous auprès de votre magasin de bricolage.

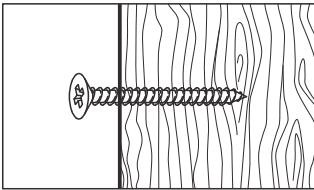

**Cartongesso o intonaco con perno di legno disponibile:**

- Con una matita, segnare il punto di fissaggio nell'altezza appropriata e posizionarlo sui perni di legno.
- Forare un punto pilota con un diametro che si accordi con la vite nei perni di legno, nell'altezza segnalata in precedenza con la matita.
- Fissare saldamente la vite come mostra l'immagine.

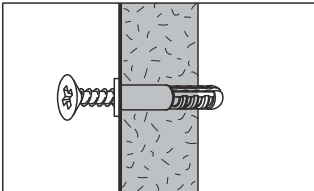

**Cartongesso senza perchio di legno disponibile:**

- Segnalare un punto di fissaggio con una matita nell'altezza appropriata.
- Forare un punto nell'altezza segnalata con un diametro che si accordi con la plastica per il fissaggio.
- Spingere il tappo di plastica attraverso il muro. Usare un martello se necessario.
- Inserire saldamente la vite nel tappo di plastica, come mostrato nell'immagine. Non stringere più del necessario.

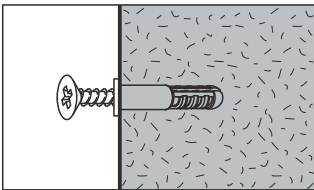

**Muratura:**

- Segnalare un punto di fissaggio con una matita nell'altezza appropriata.
- Nell'altezza segnalata con la matita in precedenza, forare un punto con diametro e profondità in accordo con la plastica per il fissaggio.
- Spingere il tappo di plastica nel muro, se necessario utilizzare un martello.
- Inserire saldamente la vite nel tappo di plastica, come mostrato nell'immagine. Non stringere più del necessario.

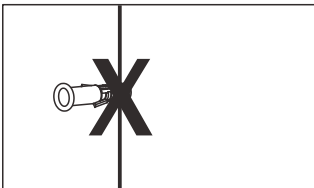

**Se la vite non può essere fissata regolarmente al muro, tenere il prodotto lontano dai bambini.**

Se il materiale del muro non è presente in questa lista, o in caso di altre domande, consultare il ferramenta della tua zona.

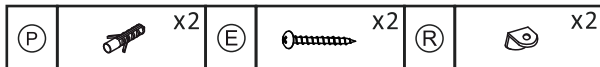

**EN - WALL ANCHORING GUIDE:** Using the guide above, identify your wall material and the appropriate steps to take for that wall material.

**DE - Anleitung zur Wandverankerung:** Ermitteln Sie anhand des folgenden Leitfadens Ihr Wandmaterial und führen Sie dann die entsprechenden Schritte für die Befestigung aus.

**ES - Guía de anclaje a la pared :** utilizando la guía a continuación, identifique el material de la pared y los pasos apropiados a seguir para ese material.

**FR - Guide de fixation murale :** à l'aide du guide plus haut, identifiez la nature du matériau et ainsi les étapes appropriées pour votre mur.

**IT - Guida per il fissaggio a muro:** Consultare la guida qui sopra, identificare il materiale della tua parete e i passaggi più appropriati alle proprie esigenze.

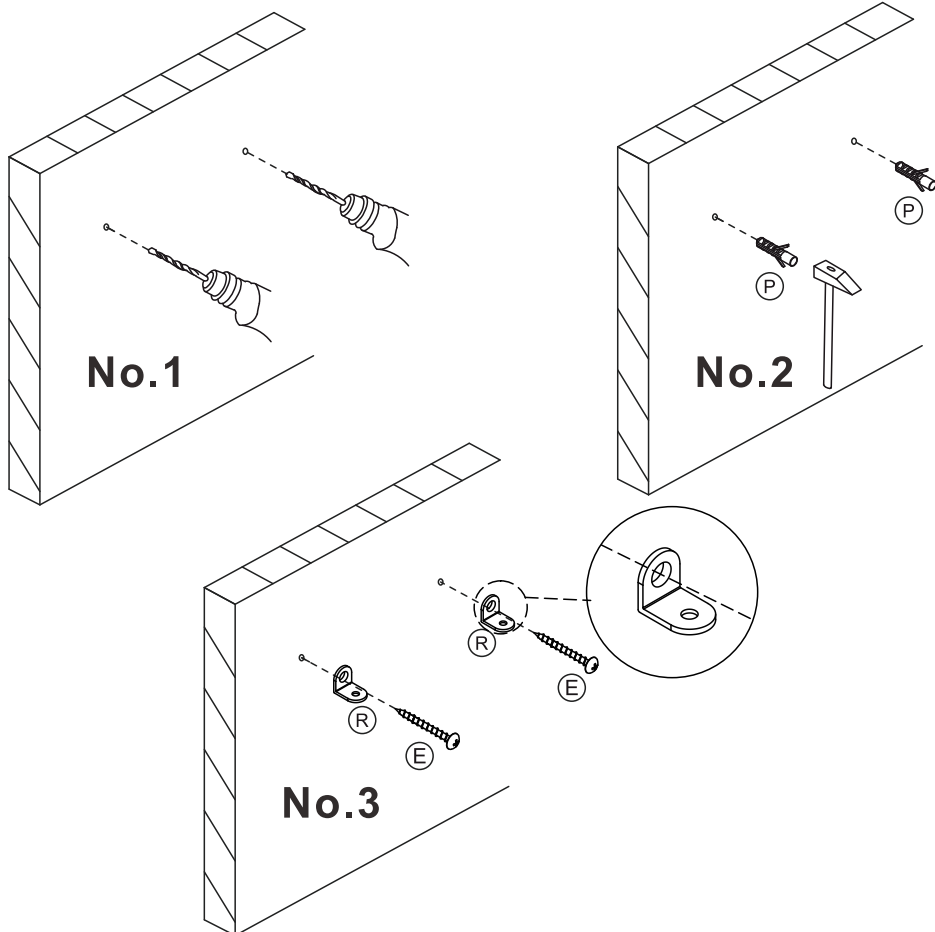

19

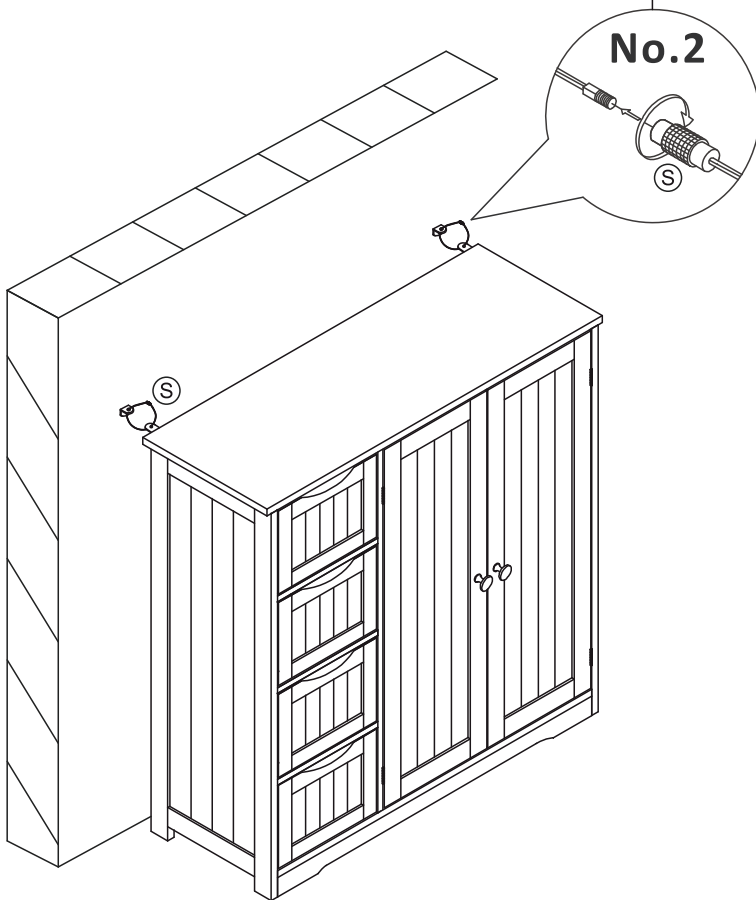
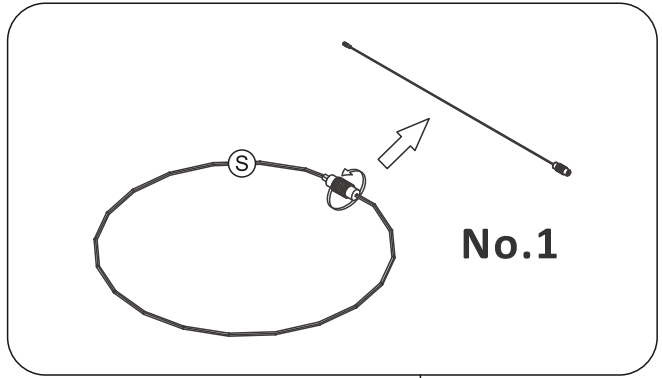

**EN : Product Care Instructions**

1. Use a soft, clean cloth or sponge to gently wipe the outer surface of the product to remove dust and dirt.

2. Avoid using chemical cleaners or harsh solvents to prevent damage to the appearance of the product.

3. Inspect the fittings (bolts, screws, nuts, etc.) every 3 months and re-tighten them every 6 months.

4. Avoid direct sunlight.

If the product shows structural damage or poses a safety hazard, stop using it until it is repaired.

**DE : Pflegehinweise für Produkte**

1. Benutzen Sie ein weiches, sauberes Tuch oder einen Schwamm, um behutsam die äußere Oberfläche des Geräts abzuwischen und Staub sowie Schmutz zu entfernen.

2. Vermeiden Sie die Verwendung von chemischen Reinigern oder scharfen Lösungsmitteln, um das Aussehen des Produkts nicht zu beschädigen.

3. Alle 3 Monate sollten Sie die Beschläge wie Bolzen, Schrauben, Muttern usw. überprüfen und alle 6 Monate nachziehen.

4. Es ist ratsam, direkte Sonneneinstrahlung zu vermeiden.

Sollte das Produkt strukturelle Schäden aufweisen oder ein Sicherheitsrisiko darstellen, sollte es nicht mehr verwendet werden, bis es repariert ist.

**ES : Instrucciones para Cuidado del Producto**

1. Utilizar un paño o una espuma suave y limpia para limpiar ligeramente la superficie exterior del producto y eliminar el polvo y la suciedad.

2. Evitar el uso de limpiadores químicos o disolventes fuertes para evitar dañar la apariencia del producto.

3. Comprobar los herrajes (pernos, tornillos, tuercas, etc.) cada 3 meses y volver a apretarlos cada 6 meses.

4. Evitar la luz solar directa.

Si el producto presenta daños estructurales o posibilidad de peligro para la seguridad, deja de utilizarlo hasta que sea reparado.

**FR : Instructions d'entretien du Produit**

1. Utilisez un chiffon doux et propre ou une éponge pour essuyer délicatement la surface extérieure du produit afin d'éliminer la poussière et la saleté.
2. Évitez l'utilisation de produits chimiques de nettoyage ou de solvants agressifs afin de préserver l'apparence du produit.
3. Inspectez les raccords (boulons, vis, écrous, etc.) tous les 3 mois et resserrez-les tous les 6 mois si nécessaire.
4. Évitez l'exposition directe aux rayons du soleil.

Si le produit présente des dommages structurels ou un risque pour la sécurité, cessez de l'utiliser jusqu'à ce qu'il soit réparé.

**IT: Istruzioni per la cura del prodotto**

1. Utilizzare un panno morbido, pulito o una spugna per pulire delicatamente la superficie esterna del prodotto e rimuovere polvere e sporco.
2. Evitare l'uso di detergenti chimici o solventi aggressivi per prevenire danni all'aspetto del prodotto.
3. Controllare le ferramenta (bulloni, viti, dadi, ecc.) ogni 3 mesi e serrarli nuovamente ogni 6 mesi.
4. Evitare la luce diretta del sole.

Se il prodotto mostra danni strutturali o rappresenta un pericolo per la sicurezza, smettere di usarlo fino a quando non viene riparato.