

**Tools you may need**

Sealant

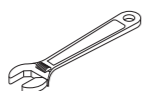

\*Scan the QR code or search HURRAN on YouTube to watch the installation video.

\* If you need installation assistance, replacement or limited lifetime warranty, please email our 24h customer service team: [hurranserviceteam@gmail.com](mailto:hurranserviceteam@gmail.com)

\* To ensure that your installation proceeds smoothly, please read all instructions carefully.

\* Please inspect the product if there is any damage during transport.

\* Thank you for choosing HURRAN.

## Installation

Prior to installation: Shut off water supply. Remove old faucet.  
Clean sink/countertop surface in preparation for new faucet  
**Important:** Clean the water supplies, prevent debris entering the faucet and damage to internal parts.

<p><b>1</b></p> <p>Pre-drilled Hole Diameter A= 7/8"-1 3/8" B= 7/8"-1 3/8" Center distance: 4"</p>	<p><b>2</b></p> <p>Sealant</p> <p>Before installing the deck plate, apply a thin bead of plumber's putty or sealant silicone to the bottom of the plate. Align and press into place.</p>	<p><b>3</b></p> <p>Insert the faucet through sink. Note: The washer is inside the mounting nut.</p>	<p><b>4</b></p> <p>Screw the nut onto shank, leaving approximately 0.12" (3mm) between the ring and the sink.</p>
<p><b>5</b></p> <p>Screw on the lock nut hand tight. Do NOT over tighten.</p>	<p><b>6</b></p> <p>Remove excessive putty, adjust slightly the position of faucet.</p>	<p><b>7</b></p> <p>Using wrench to tighten the supply hoses. Note: Don't severely kink the hose.</p> <p>Hot Cold</p>	

Note 1. Allow hot & cold water to run for at least 20 seconds each. Important: This flushes away any debris that could cause damage to internal parts. Check all connections for leaks. Re-tighten if necessary, but do not overtighten.

Note 2. If the water flow is too small during use, you can manually disassemble the bubbler shell for cleaning and reuse, or replace the optional. Note: the direction of the aerator.

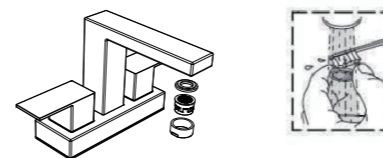
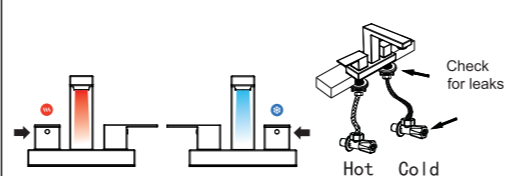

## Pop-up Drain Installation

### 1 Preparing the pop-up assembly

- Remove the bottom gasket (N) and nut (O) from the top gasket (L) and pop-up body (M).
- Attach these pieces together by pushing the bottom gasket (N) down into the top of the nut (O) and twisting together.

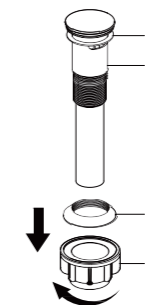

### 2 Installing the pop-up body

- Insert the pop-up body (M) into the sink. Ensure that the top gasket (L) rests securely between the top of the sink and the top of the pop-up body (M).

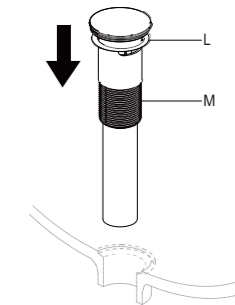

### 3 Securing the pop-up body

- From underneath the sink, screw the bottom gasket (N) and nut (O) assembly onto the pop-up body (M) by twisting clockwise until secure. Hold the bottom of the drain pipe with one hand and tighten the nut with the other hand.

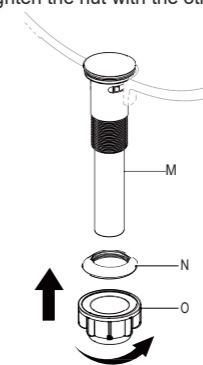

### 4 Rock the drain up to ensure that the drain will not be shaken. Close the drain and fill the sink with water. Check for leaks. If water is leaking from the drain, refer to step N or O.

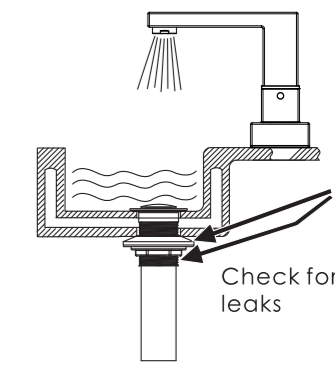

## Cleaning and Care

Simply wipe gently with a damp cloth and blot dry with a soft towel.

Do not use abrasive cleaners, steel wool, or harsh chemicals when cleaning this faucet.

# Product List

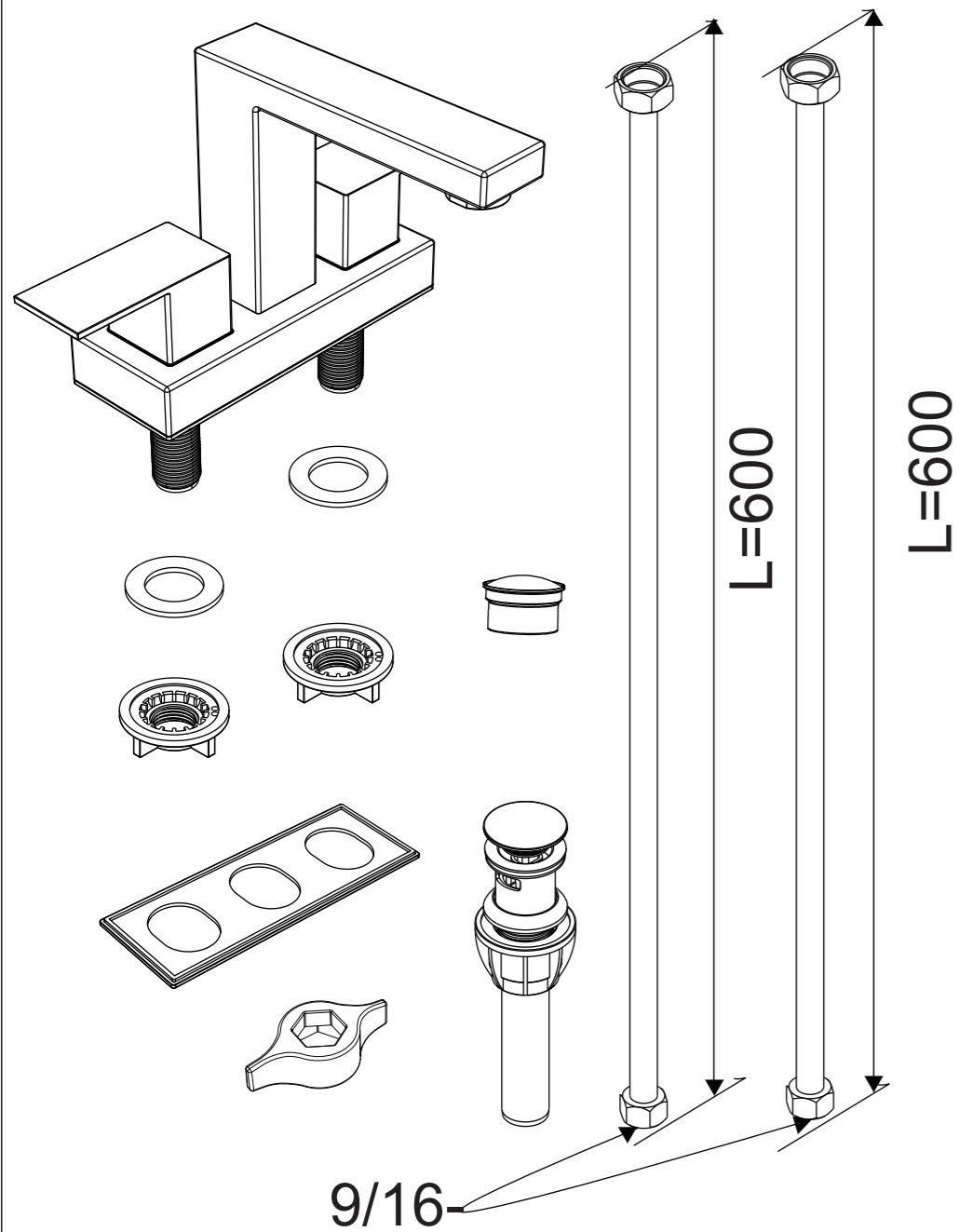

**A**

**Use the wrench to connect and tighten the water supply line connection.**



**D**

**Do not severely kink the water supply line. Otherwise, the supply lines will easily burst or even break.**

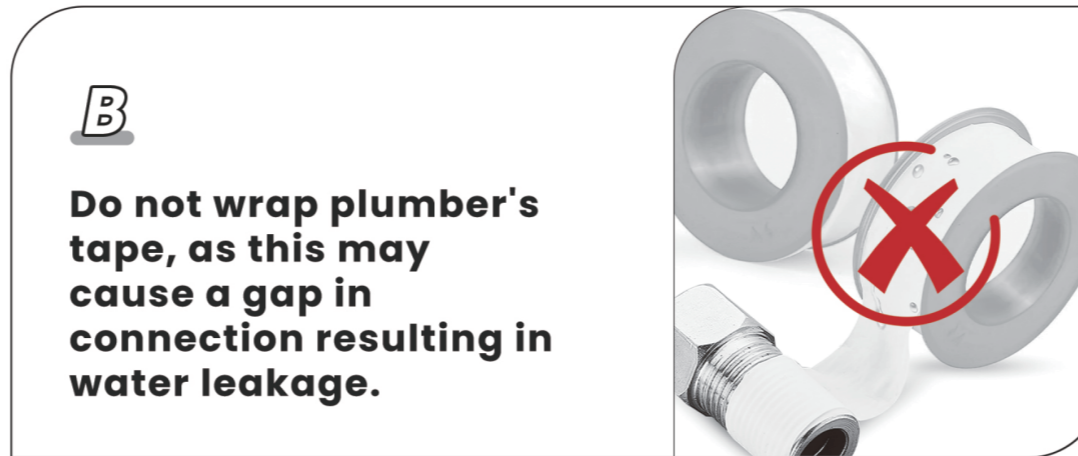

**B**

**Do not wrap plumber's tape, as this may cause a gap in connection resulting in water leakage.**

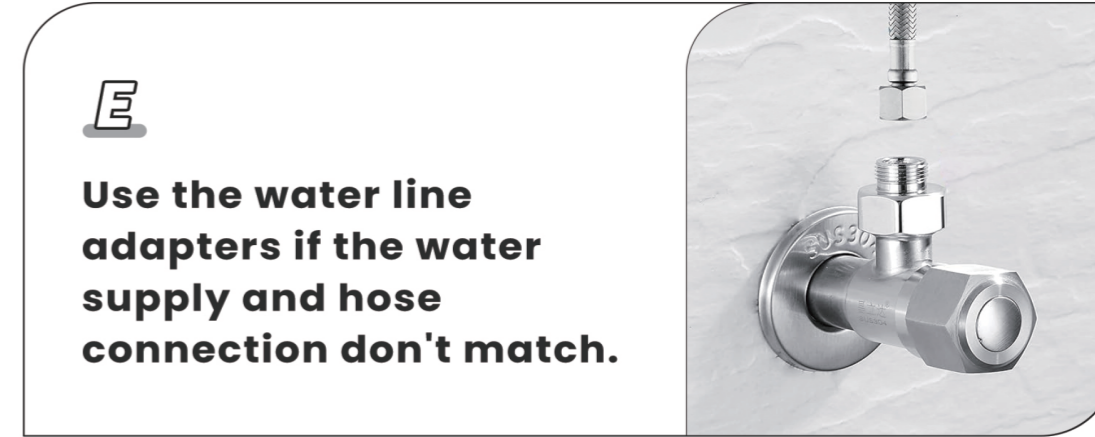

**E**

**Use the water line adapters if the water supply and hose connection don't match.**



**C**

**Before installation, please flush the angle valve for 30-60 seconds until the water is clean.**

If you need installation assistance, replacement or limited lifetime warranty, please email our 24h customer service team: [hurranserviceteam@gmail.com](mailto:hurranserviceteam@gmail.com)