



# Assembly Instructions



Caution : Please read instructions thoroughly before unpacking assembly parts .

1. We recommend that you should assemble this product with the assistance of another person ; this will make assembly easier , and will help to eliminate damage to the product or injury to persons during assembly.
2. Be sure to check all packing materials carefully for small parts that may have come loose inside the carton during shipment.
3. Please do not over tighten screws or bolts until the assembly is completed.
4. Please put all parts on a non - abrasive floor before assembly , and follow the assembly steps to assemble your newly purchased product correctly and efficiently.

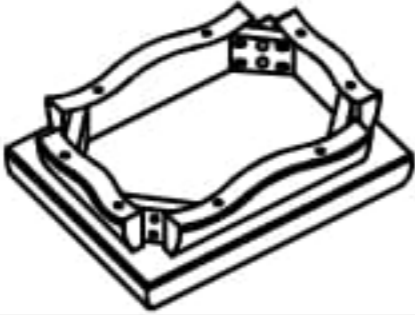
## HARDWARE / PARTS LOCATION

- > Step 1 hardware > Inside red pack with red tape > Placed beside seat
- > Leg & Stretcher > Inside labeled inner carton > Placed between seat

No	Component List	Qty
A	Vanity Bench 	1Pc
B	Leg 	4Pcs

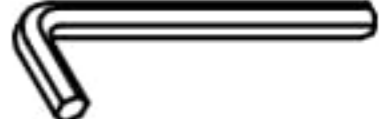
Hardware List			
No	Dimension	SKETCH	QTY
1	Flat Washer (1/4" * 22mm)		8Pcs
2	Spring Washer (1/4" )		8Pcs
3	Bolt (1/4" * 63.5mm)		8Pcs
4	Allen key 4mm		1Pc

### Step 1:

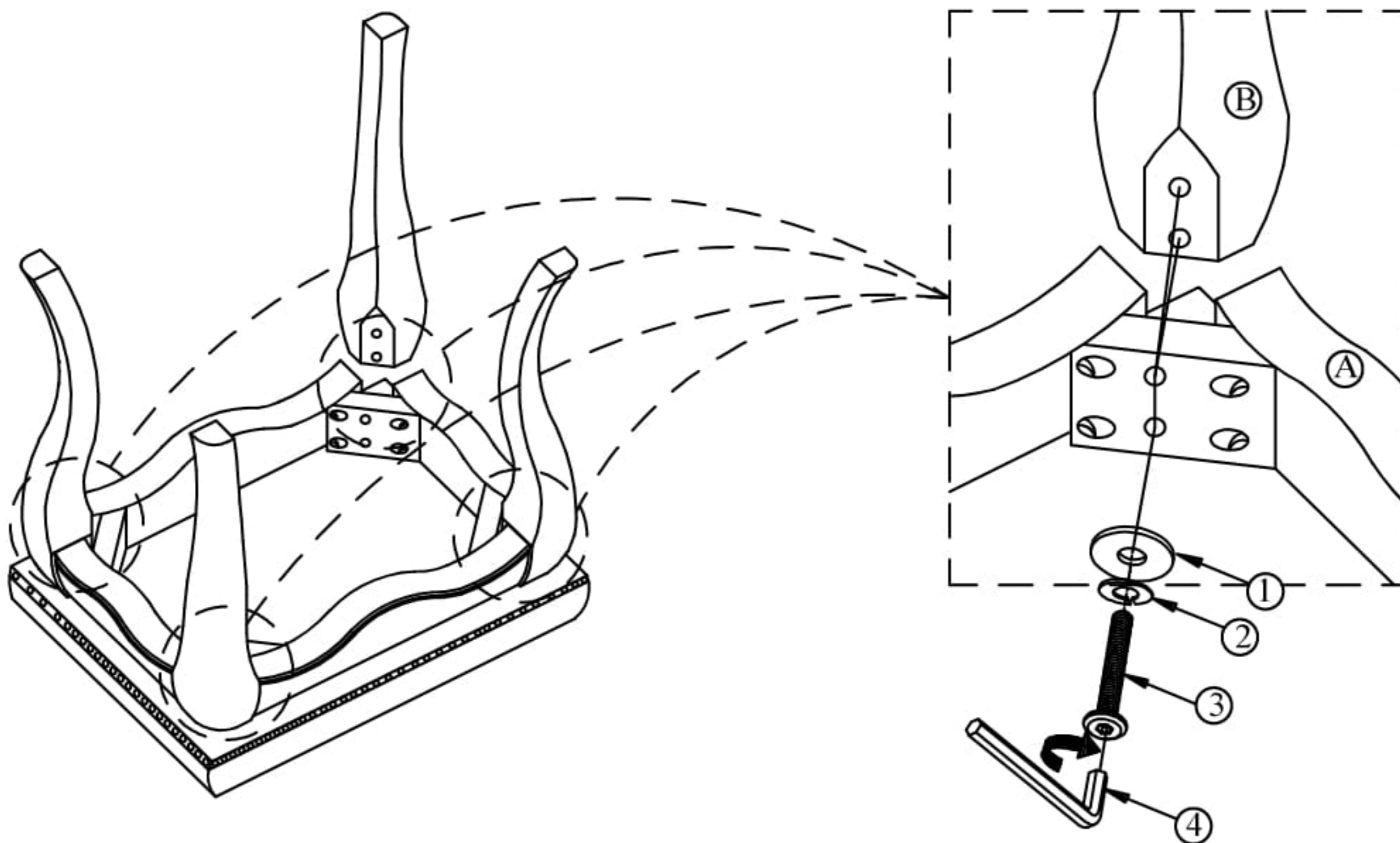

### Step 2:

