







OUTDOOR FOUNTAIN

ASSEMBLY CARE & USE INTRUCTIONS

IMPORTANT, RETAIN FOR FUTURE REFERENCE.READ CAREFULLY

PACKAGE CONTENTS

Please lay out all parts prior to assembly or installation. Read instructions prior to assembly or installation.

PART #	PART DESCRIPTION	QUANTITY	PART #	PART DESCRIPTION	QUANTITY
RB-1		1	RB-5	 Shim	6
			RB-6	 Screwdriver	1
			RB-7	 Pump	1
RB-3	 Cap	1			
RB-4	 Pump Connector	1	RB-8	 AC adapter	1



IMPORTANT: Our fountain has been designed for easy assembly. It should take a team of two people less than half of hour to assemble.

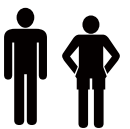

While installing, keep children and pets out of reach. Remember to make sure the plug is dry and clean before inserting into the ground fault circuit interrupter (GFCI) outlet.

! WARNINGS AND CAUTIONS-RISK OF SHOCK

- **To reduce the risk of electric shock**, use only on portable self-contained fountains no larger than 5 feet in any dimension.
- The National Electric Code requires that a ground fault interrupter circuit (GFCI) be installed in every branch circuit supplying the fountain or pond equipment.
Do not immerse the plug in water. DO NOT REACH INTO THE WATER TO REMOVE THE PLUG. TURN OFF CIRCUIT FIRST.
- A "drip loop" in the cords should be used. A "drip loop" is a loop in the cord below the level of the receptacle or plug that prevents water from traveling along the cord.
WARNING: FOR YOUR PROTECTION, ALWAYS UNPLUG THE UNIT FROM ITS POWER SOURCE BEFORE INSTALLING OR SERVICING.
- DO NOT REACH, REMOVE, OR DISASSEMBLE THE PUMP BEFORE YOU DISCONNECT THE POWER.

ASSEMBLY INSTRUCTIONS

1、 Remove cap from tube.

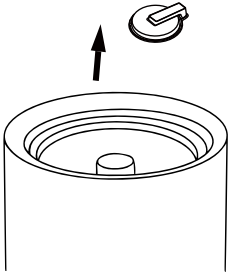

2、 Run cable from pump through tube and pull through notch in base.

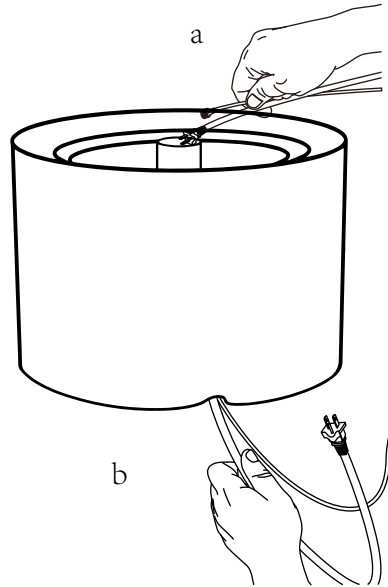

3、 Replace cap from step 1 on top of tube in base.

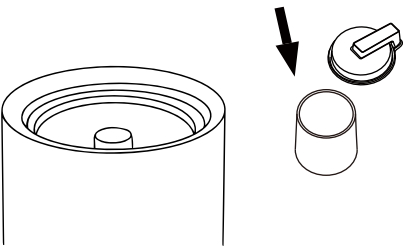

4、 Two people carefully lift fountain top to base



5、 Connect lighting cord from fountain top to the base

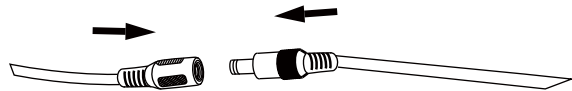

6、 Slide tubing with clamp on to the pump connector and tighten with screwdriver tool. Connect transformer.

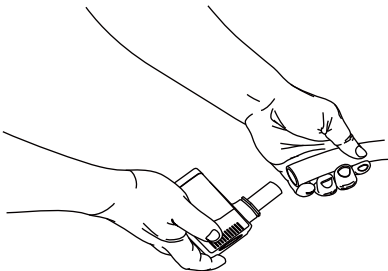

7、 Add clean water to base.
Put the fountain top to the base and Connect transformer.

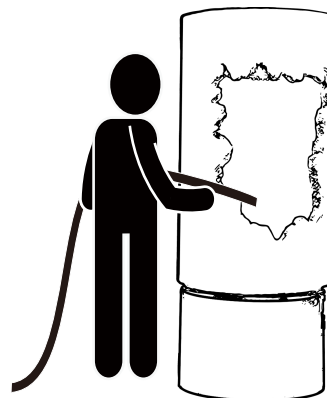

CARE AND MAINTENANCE

- Regular cleaning of the pump may be necessary depending upon the environment in which it is operated. Clean the pump and the impeller assembly when it is visibly soiled or when a drop in performance is detected.
- Before cleaning, always disconnect the pump from the power source.
- Disassemble the pump cover and remove the impeller cover to expose the impeller assembly. Remove the impeller assembly by gently pulling on the impeller blades. Use a soft cloth or brush to clean the impeller assembly and the inside of the impeller housing.
- Remove all parts from the pump and clean in warm, soapy water.

TROUBLESHOOTING

If the pump fails to operate:

- Check the circuit breaker and try another outlet to ensure the pump is getting electrical power.
- Check the pump outlet and tubing for kinks or obstructions. Algae build up can be flushed out with a Garden hose.
- Check the bottom of pump to confirm that the intake screen it is not clogged with debris.
- Remove the front cover, and impeller cover to expose the impeller. Turn the impeller to ensure that it is not broken or jammed.

If the performance of the pump is not satisfactory or the pump does not flow evenly:

- Check to make sure the impeller assembly, water sensor, and the front cover are clean.
- Adjust flow control knob as needed.

RELACEMENT PARTS LIST

Part	Description
A	1/2 in. ID tubing adapter
B	Pump housing
C	water level controller
D	Rotor
E	Gland
F	Filter
G	Suction cap

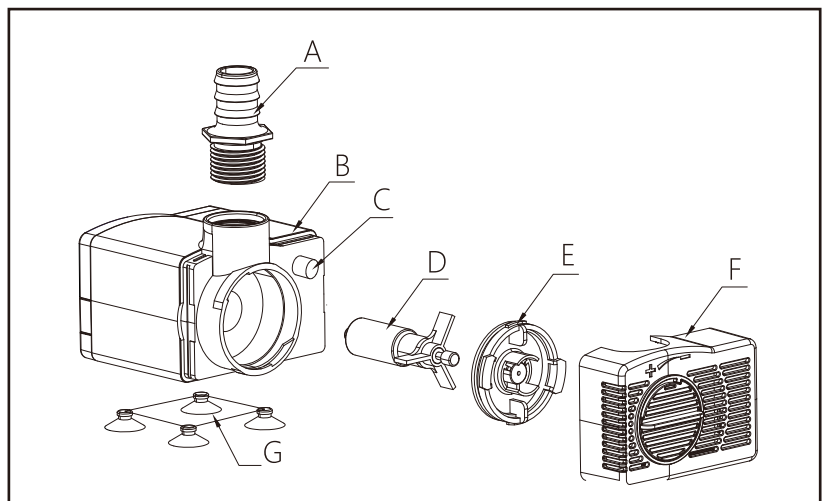



WINTERIZATION AND STORAGE

DO NOT ALLOW WATER TO FREEZE IN FOUNTAIN OR PUMP

- If fountain is used in areas with harsh winters where temperatures can drop below freezing even for short periods of time, it is recommended that all water be removed from the fountain during the cold months.
- Also remove the pump by disconnecting from the hose. Clean the pump with plain water and dry it thoroughly before storing the pump in a temperature controlled atmosphere (above freezing).
- If pump is removed, clean it with fresh water and dry it thoroughly before storing. It is strongly recommended to clean the impeller assembly and chamber before storing.
- **We recommend that you store the fountain during the winter in a climate controlled garage/shed or cover completely with an outdoor tarp.**

IMPORTANT SAFETY INSTRUCTIONS - SAVE THESE INSTRUCTIONS

This manual contains important safety and operating instructions for power units.

When using electrical products, basic precautions should always be practiced including the following:

READ AND FOLLOW ALL SAFETY INSTRUCTIONS.

Read and follow all instructions that are on the product or provided with the product.

- Do not use an extension cord.
- Reference the National Electrical Code, ANSI/NFPA 70, specifically for the installation of wiring and clearances from power and lighting conductors.
- Installation work and electrical wiring must be done by qualified person(s) in accordance with all applicable codes and standards, including fire-rated construction.
- Do not use in a bathroom.
- Do not install or use within 10 feet of a pool
- **WARNING: Risk of Electric Shock.** When used outdoors, install only to a covered Class A GFCI protected receptacle that is weatherproof with the power unit connected to the receptacle. If one is not provided, contact a qualified electrician for proper installation. Ensure that the power unit and cord do not interfere with completely closing the receptacle cover.

WARNING: Risk of Fire. Installation involves special wiring methods to run wiring through a building structure. Consult a qualified electrician.

CAUTION

- This pump has been evaluated for use with fresh water only.
- Use a proper power source as indicated on the pump label.
- Keep the cord away from high temperatures or other heat sources.
- Do not pump heated liquids.
- Avoid heavily chlorinated water and water with high pH levels.
- Do not lift the pump by its power cord.

LIMITED WARRANTY-PUMPS

- Our fountain pumps come with a 1 year limited warranty against manufacturing defects.
- The warranty does not cover damage as a result of electrical supply problems, abuse, or misuse.
- Any damages due to improper installation are not covered by this warranty.