

Assembly Instructions

Caution: You must read this before you proceed

Please look in the Seat Panel for Hardware Packs

SWING





CAUTION: This Swing is NOT a TOY.





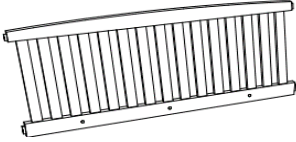
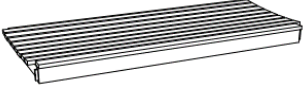

Keep your child / children at bay during the assembly process.

Whenever lifting or moving the Swing and to prevent damage to the Swing, two adults may be needed to execute these actions.

Parts List

Label	Picture	Description	QTY
A		Backrest Panel	1
B		Seat Panel	1
C		Left Arm Panel	1
D		Right Arm Panel	1

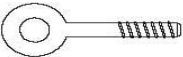
Hardware

Label	Picture	Description	QTY
①		Bolt (M6 x 35mm)	4
②		Screw (M7 x 70mm)	7
③		Washer (Ø8,5/20 x 2 mm)	9
④		Chain (Ø5 x 2440mm)	4
⑤		Carabiner (M8)	6
⑥		Eye Bolt (Ø8 x 25 mm)	8
⑦		Sleeve Nut (M8x18mm)	9
⑧		Allen Wrench	2

Assembly Preparation

Before Beginning Assembly:

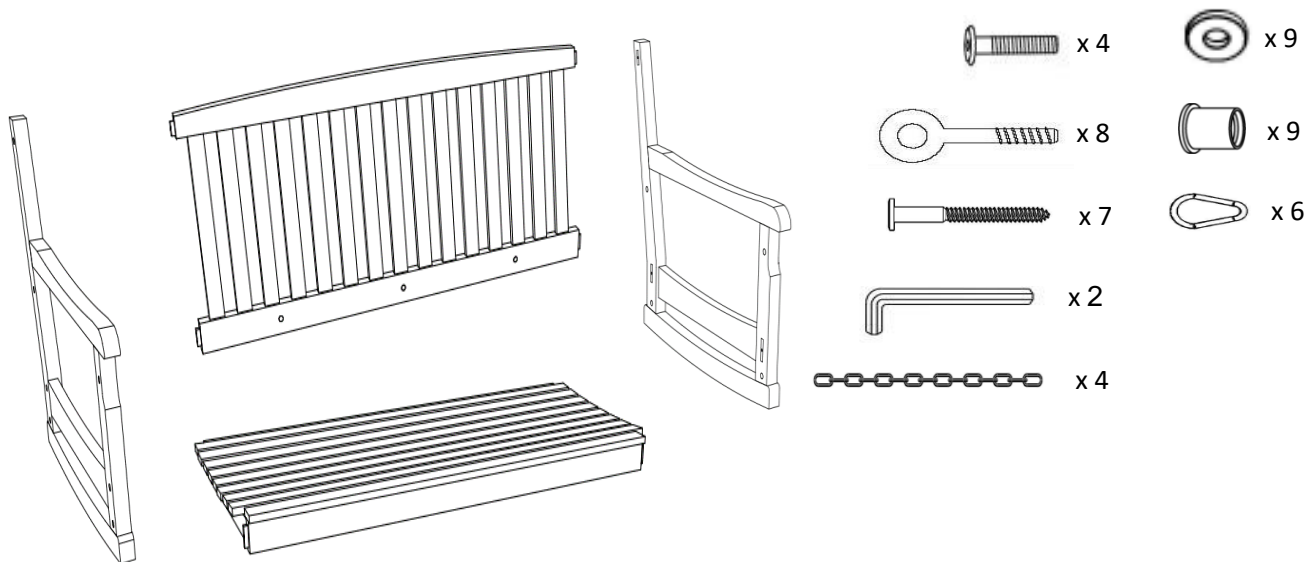

- Read instructions, cover to cover-



- Have 2 adults on hand for assembly-



- Do not assemble on flooring or carpet-



- Assemble on a clean non-marring surface (packing foam)-



- Save all packaging until finished-

Assembly Steps

OVERVIEW

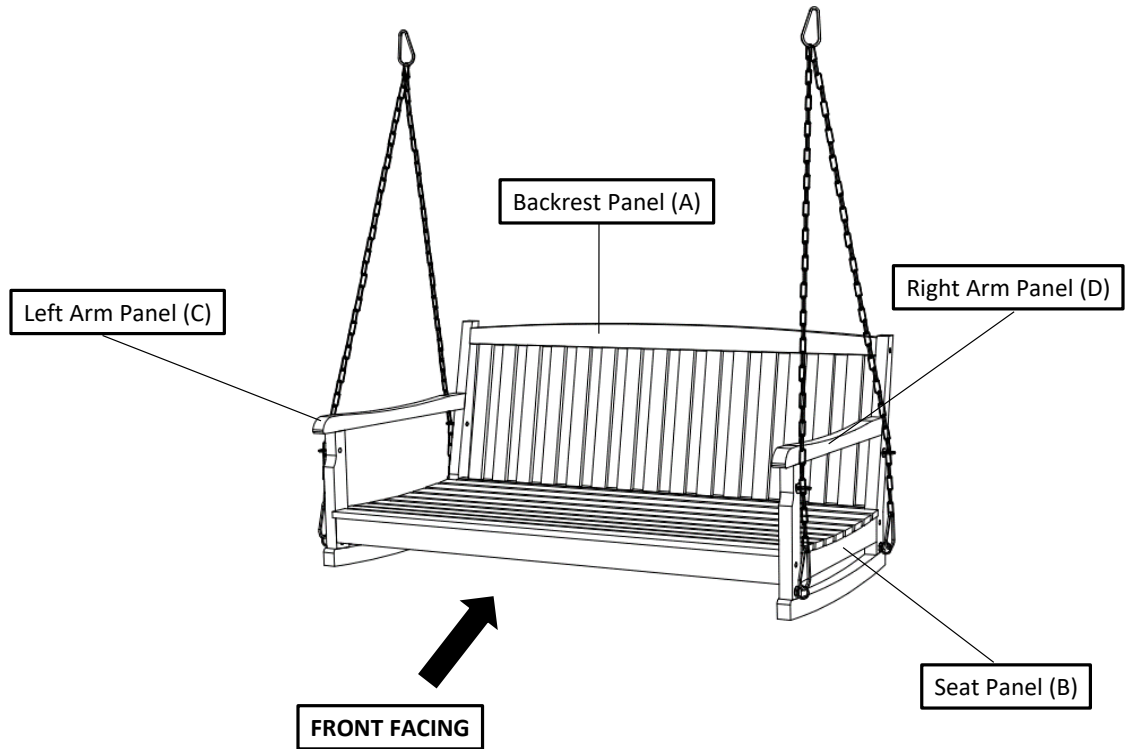

This Swing has multiple parts and may require up to some 30 minutes to assemble. To give you an overview of the Swing parts, the above picture is to help you put the various parts into perspective. Please read through the instructions below to familiarise yourself with the parts and steps before assembly.

Step 1

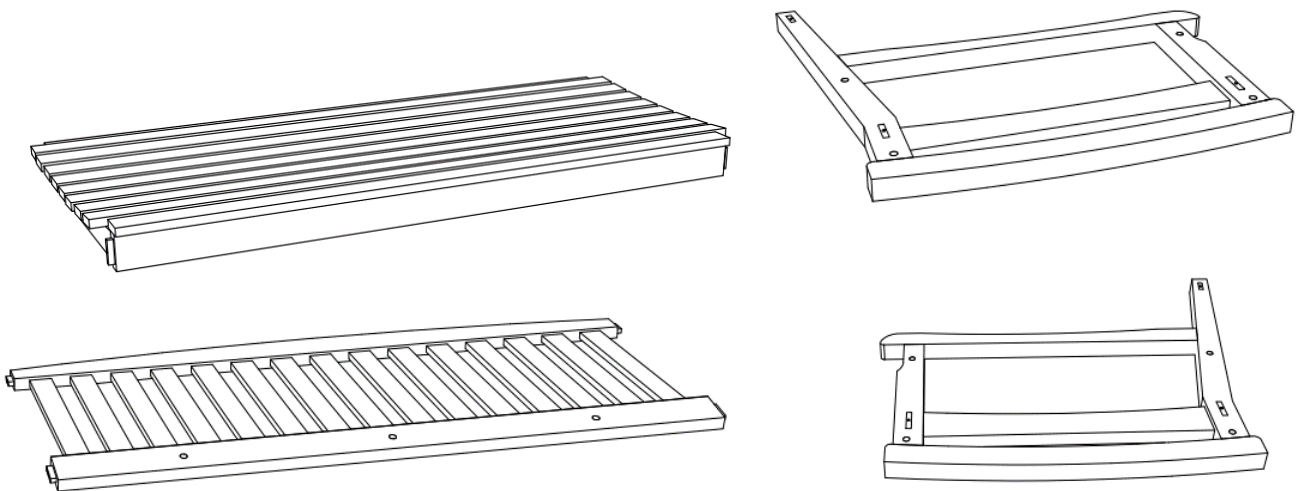

Unpack and place all parts on a clean, non-marring surface.

Step 2

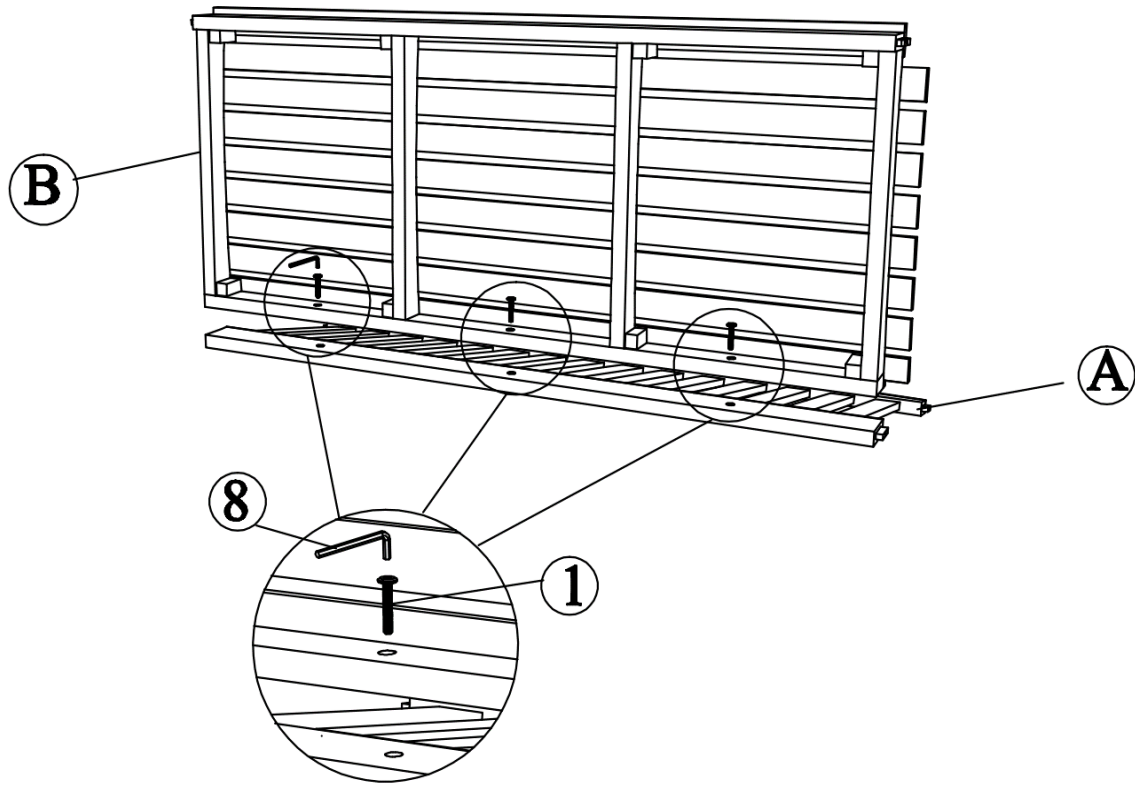

With assistance from your adult partner, attach the Seat Panel (B) to the Backrest Panel (A) using Bolts (1) with the Allen Wrench (8) as shown above.

Do not fully tighten the Bolts.

Step 3

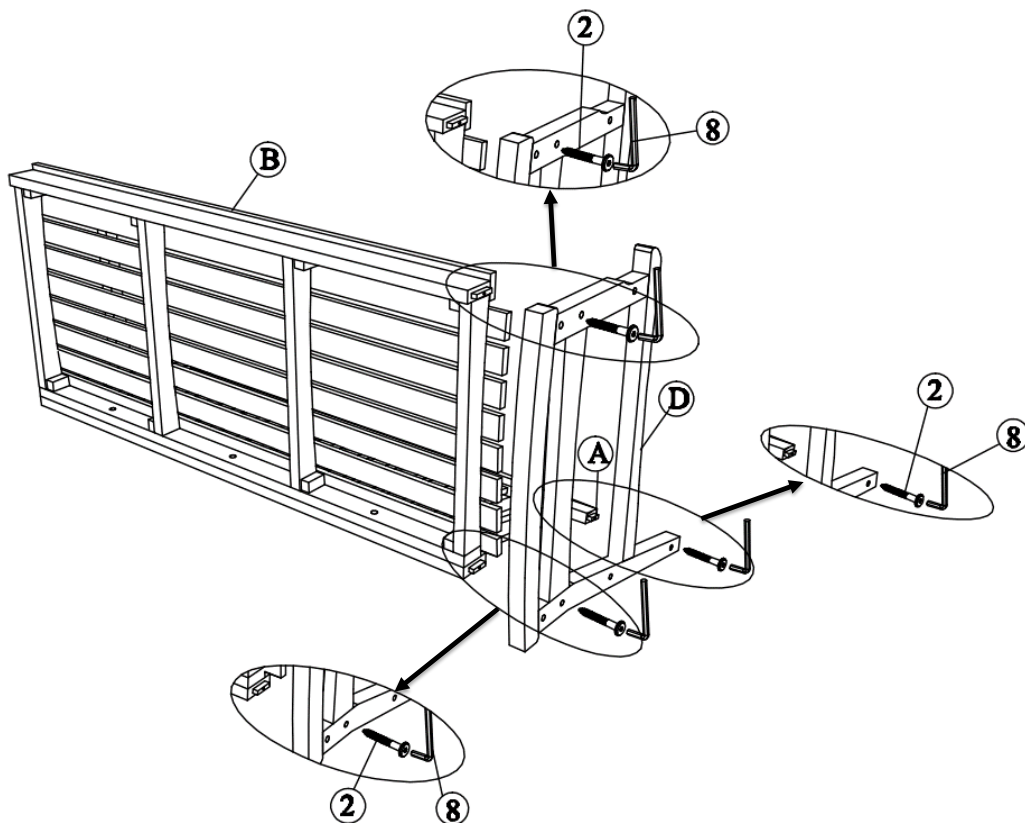

With the assistance from your adult partner, Attach the Right Arm Panel (D) to the Backrest Panel (A) and the Seat Panel (B) of the assembled part in Step 2 using Screws (2) and the Allen Wrench (8) as shown above.

Repeat the same process with the Left Arm Panel (C).

Do not fully tighten the Screws.

Step 4

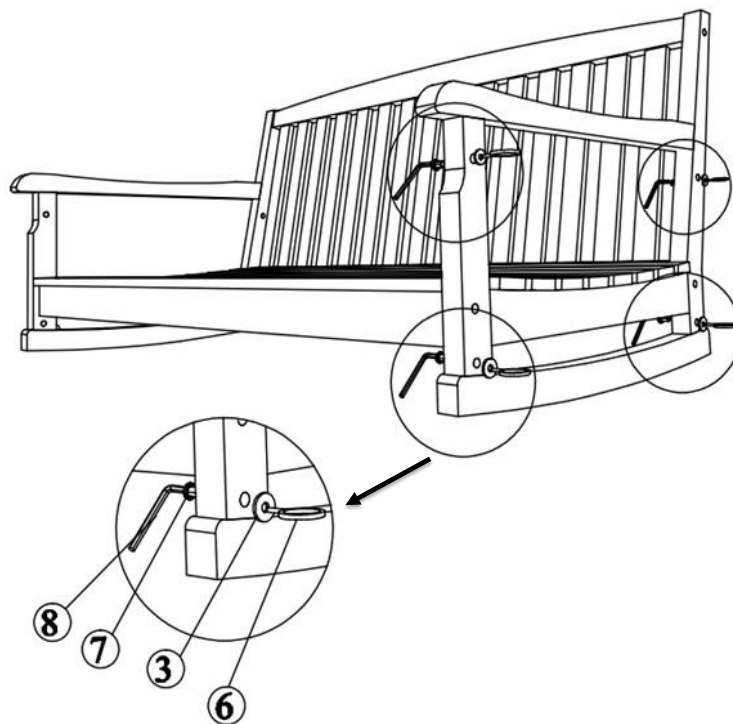

With the assistance from your adult partner, turn the assembled part in Step 3 right side up. Connect the Eye Bolts (⑥) to the Right Arm Panel (D) using Sleeve Nuts (⑦), and Washers (③) with the Allen Wrench (⑧) as shown above.

Repeat the same process with the Left Arm Panel (C).

Do not fully tighten the Bolts.

Step 5

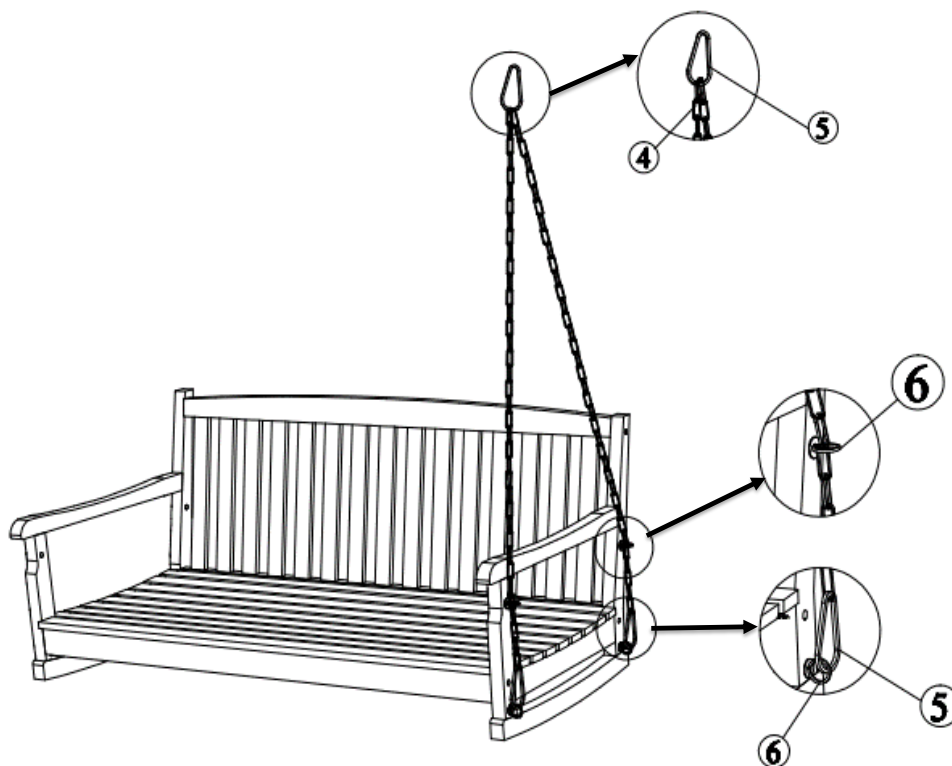

With assistance from your adult partner.

Step 5.1 Unscrew the connection on the Carabiner (⑤) and loop the Chain (④) onto the Carabiner (⑤), then screw the connection shut as shown above.

NOTE: The distance from the Carabiner (⑤) to the back of the Right Arm Panel (D) is shorter than the distance from the Carabiner (⑤) to the front of the Right Arm Panel (D).

Step 5.2 Align the Chain (④) through the holes of the Right Arm Panel (D). Then lock the end of the Chain to the Eye Bolts (⑥) on the Right Arm Panel (D) as shown above.



















Repeat the same process with the remaining Carabiners (⑤) and Chain (④) onto the Left Arm Panel (C).

Step 6



Then carefully sit onto the Swing.
This pressure will help the Swing reach full alignment at all joints.
In a sequential manner, gradually tighten all Bolts and Screws until evenly secured.
Inspect the Swing and make sure all parts are adequately connected.
Your Swing is ready for use.
This Swing can only be used on a flat, level surface.

Care & Maintenance

-   ● Do not put hot items directly on furniture surface
 -   ● Do not clean furniture with harsh cleansers or polish.
 -   ● To obtain the longest lifespan of your outdoor products, minimizing exposure to direct sunlight is recommended.
 -   ● Children should not climb or jump on the furniture.
 -   ● Do not write on furniture without a padded barrier to protect the surface.
 -   ● To obtain the longest lifespan of your outdoor products, avoid extended and lengthy exposure to rain, snow, and direct sunshine. Whenever possible cover the product and /or place under patio or awnings.
 -   ● Not for commercial use. For residential use only .
 -   ● Stains may be removed with mild soap solution and damp cloth.
-
-   ● Dust and pick-up spills using a clean, non-colored, lint-free cloth .