

Important Safety Instructions

1. Read all instructions and safety information before installing your new fan. Review the accompanying assembly diagrams.
2. Before installing the fan, disconnect the power by removing fuses or turning off circuit breakers.
3. Make sure all electrical connections comply with local law and the national electrical code. Please hire a qualified electrician or consult a do-it-yourself wiring handbook if you are unfamiliar with installing electrical wiring.
4. Make sure the installation site is roomy enough to allow fan blades to rotate. There is at least seven feet from the floor to fan blades' tips.
5. If you are mounting the fan on a ceiling outlet box, please use a metal outlet box. Secure the box directly to the building structure. The outlet box and its support must be able to support the rotating fan (at least 50 lbs). Do not use a plastic outlet box. Attach the mounting bracket using the ceiling outlet box's hardware.
6. If you are mounting the fan on a joist, make sure it is strong enough to support the rotating fan (at least 50 lbs).
7. After installing the fan, make sure all the connections are secured so that the fan won't fall.
8. Do not insert anything between fan blades while the fan is operating.
9. Turn the fan off and wait for it to stop before reversing fan's rotating direction.
10. To reduce the risk of electrical shock and personal injury, do not install the fan on a sloped ceiling and do not use this fan with any solid-state fan speed control device, or rheostat. You must install the outlet box using the two steel screws and lock washers coming with the fan.

BEFORE YOU START

Contact a licensed electrician if you are not good at performing electrical work. It's the licensed electrician who installs the fan, if required by the local code. Do not use the fan with a dimmer switch. Turn off power at breaker.

BEFORE YOU START

Contact a licensed electrician if you are not good at performing electrical work. It's the licensed electrician who installs the fan, if required by the local code. Do not use the fan with a dimmer switch. Turn off power at breaker.

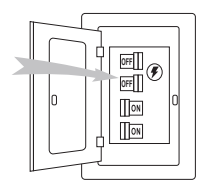



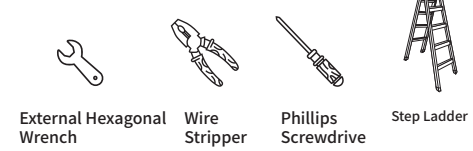

Tools and Materials Required

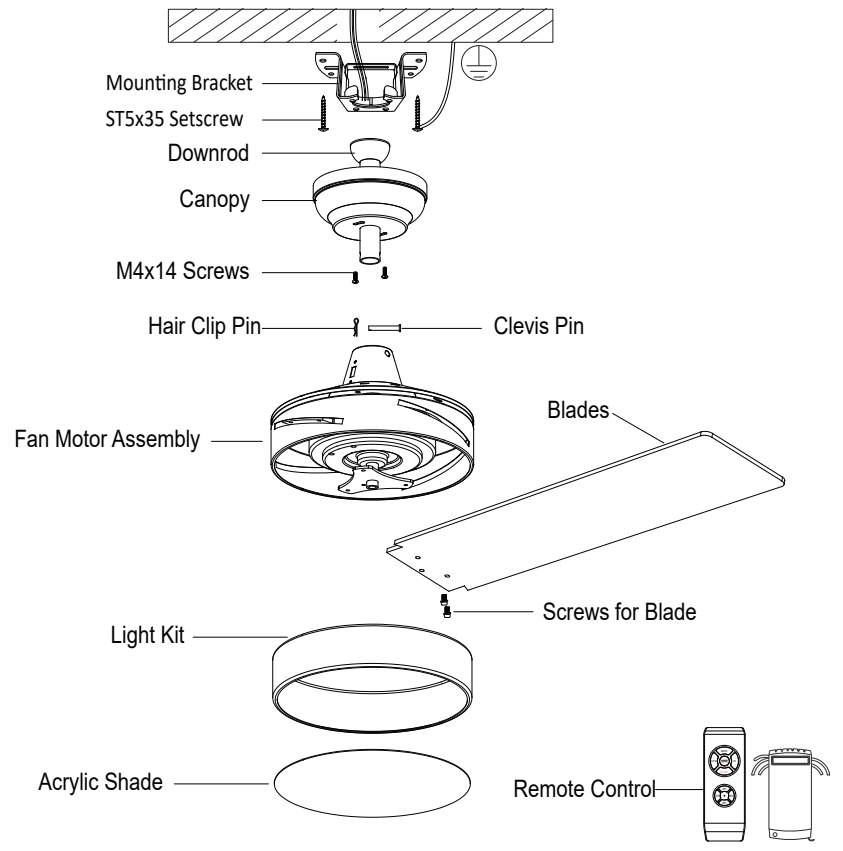

Product Instruction

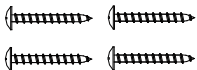

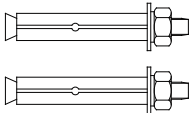
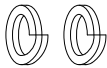
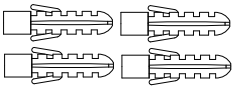
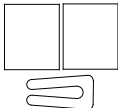
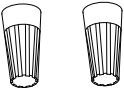
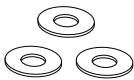
SCREWS BAG

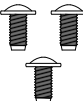
Item no.	Reference Image	Qty.	Item no.	Reference Image	Qty.
1	 ST5x35 Setscrew	×4	6	 Screw Washer	×2
2	 Expansion Screw	×2	7	 Screw Spring Washer	×2
3	 Setscrew Stopper	×4	8	 Balance Pack	×1
4	 Wire Cap	×2	9	 Fabric Washer	×13
5	 #8-32 Setscrew	×2	10	 Screws for Blades	×13

INSTALLING THE FAN

Tools Required: Phillips screwdriver, a pair of pliers, straight slot screwdriver, adjustable wrench, step ladder, and wire cutters.

INSTALLING THE MOUNTING BRACKET

The ceiling fan must be installed in the location where there is 12" (300mm) spacing from the tips of all blades to the nearest objects or walls. REMEMBER to turn off the power before hanging the fan. Follow the instruction below to hang your fan properly:

1. For concrete ceiling, drill two holes in the ceiling and secure the mounting bracket to the ceiling with two $\Phi 0.32$ " (8mm) (distance between the two holes should be appropriate) expansion screws, flat washers nuts provided and tighten with a spanner.

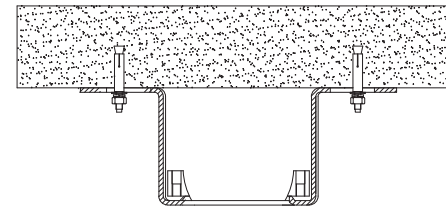

2. For wood ceiling, secure the mounting bracket to the ceiling that is capable of carrying a load of at least 100lbs (45kgs) with two long mounting screws and washers provided. Be sure at least 0.12" (30mm) of the screw is threaded into the support.

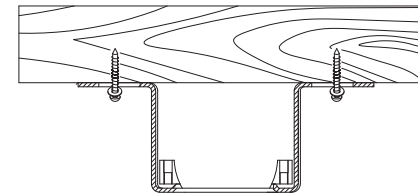

3. For installing the outlet box, secure it directly to the building structure. Use appropriate fasteners and building materials. The outlet box and its support must be able to fully bear the moving weight of the fan (at least 100lbs). Use a UL listed metal outlet box instead of plastic ones. Figure 1 & 2 show the examples of mounting the outlet box.

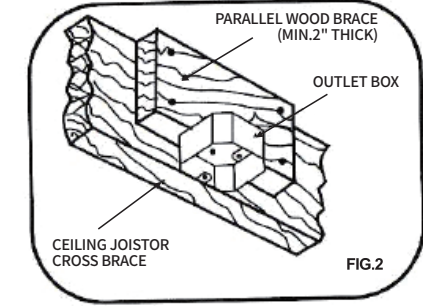
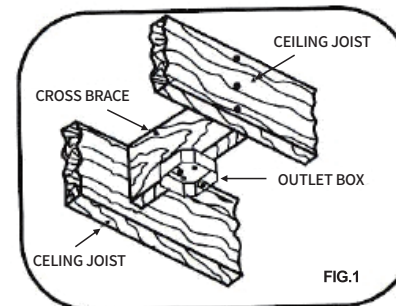

4. Refer to the Fig. on the right to mount when the ceiling is angled (Max. 15°).

NOTE: The hanger must be able to withstand 100lbs (45kg) or more after the installation.

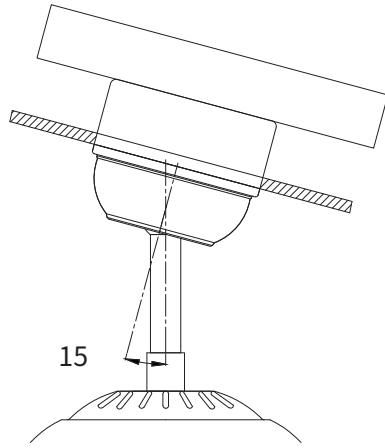

INSTALLING THE BLADE

- 1) Attach blade brackets to blades using the blade bracket screws and metal or fabric washers.
- 2) Assemble the blade assembly with the screws provided.

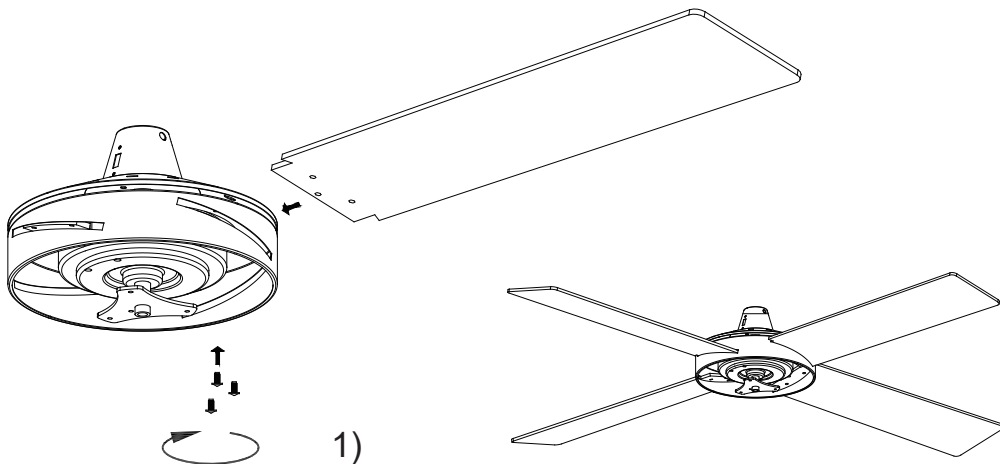

5

INSTALLING THE DOWNROD

REMEMBER to turn off the power before hanging the fan. Follow the steps below to hang your fan properly:

1. Thread the suspender through the suspended clock and coupling cover.
2. Then insert the tail of the suspender from the lifting head of the motor.
3. After the lateral pin is threaded out from the suspended head position, insert R type pin.
4. Tighten the lifting head screws.
5. Hang the fan of the hanging pipe into the hanger.

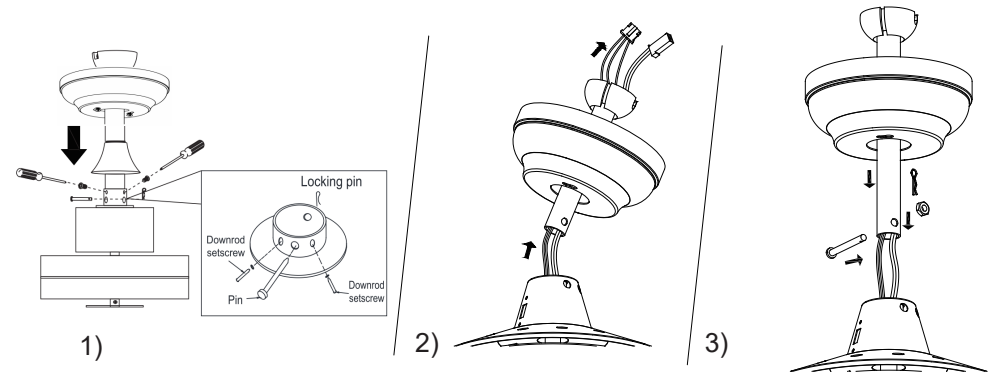

INSTALLING THE FAN TO MOUNTING BRACKET ON CEILING

⚠ WARNING: To avoid possible electrical shock, be sure the electricity is turned off in the main fuse box before wiring.

Carefully lift the fan assembly onto mounting bracket and rotate the fan until the notch on downrod ball "1" engages the ridge on the mounting bracket "2".

This will allow for hands free wiring.

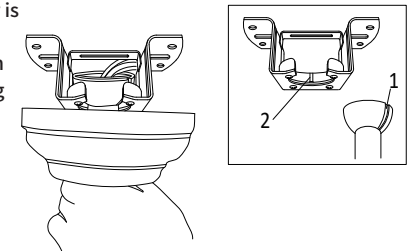

6

MAKE THE ELECTRIC CONNECTIONS

WARNING: To avoid possible electrical shock, be sure the electricity is turned off in the main fuse box before wiring.

1. Connect the fan to the remote control. The fan's 3P plug should insert into the the remote control's 3P plug.
2. Connect the remote control to the house's power line, then connect the remote control's white wire to the house's white wire. Connect the remote control's black wire to the house's black wire, and connect all the fans' green ground wires to the house of ground wires. Secure wires.
3. Connect the fan motor to the lamp: connect the fan motor's 1P white wire to the lamp's 1P white wire. Connect the fan motor's 1P blue wire to the tool's 1P blue wire.

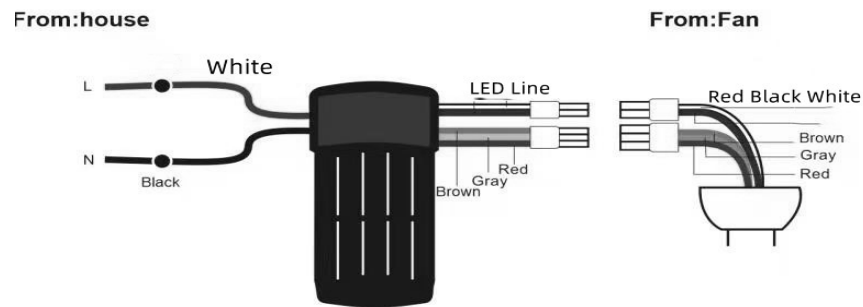
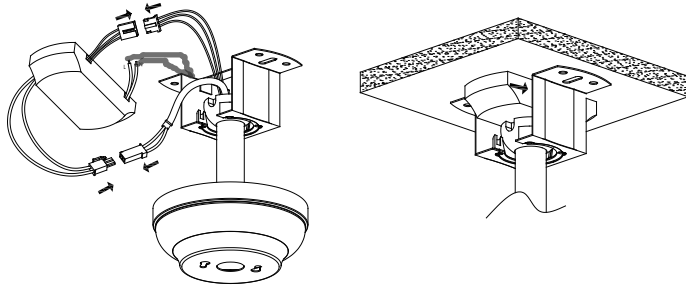

INSTALLING THE LIGHT KIT

1. Remove 3 mounting screws from the light kit.
2. Find the Molex connector from the motor and the Molex connector from the light kit. Slide them together.
3. Install the motor's junction box with 3 screws and tighten light kit.
4. Carefully install the panel shade into the main body and turn it clockwise to lock.

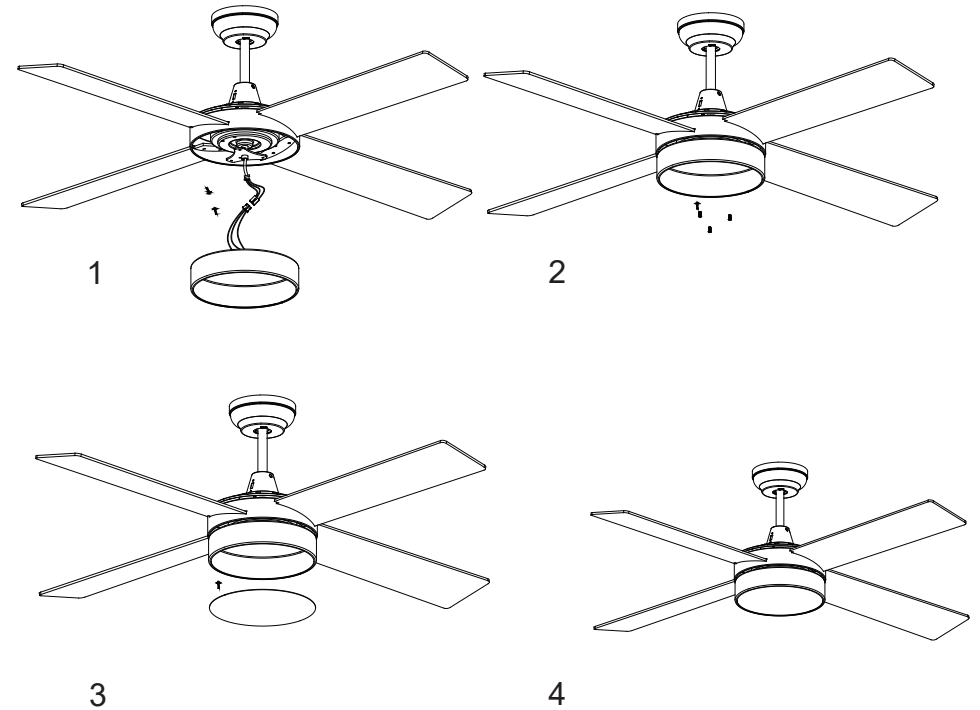

Installation is now finished. Turn on the power switch as Fig 7. Then the fan lights are on. Test and pair your fan immediately using the remote control.

INSTALLING THE CANOPY

Loosen the 2 screws on the bottom of mounting bracket but do not remove them. Raise the canopy up and align the keyholes on the bottom of the canopy with the 2 screws on the bottom of mounting bracket. Rotate the canopy until both screws from the mounting bracket drop into the slot recesses. Tighten screws.

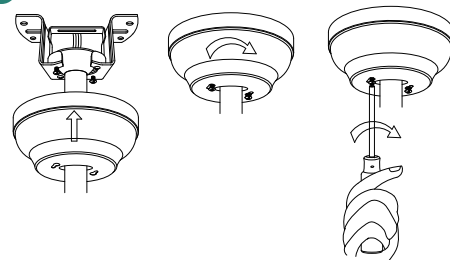

7

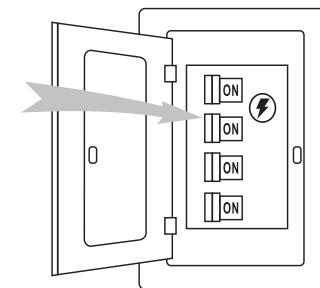

8

OPERATING YOUR FAN

Turn on the power and check the operation of the fan: Kindly remind that the appropriate speed settings of warm or cool weather depend on many factors such as the room size, ceiling height, and the number of fans.

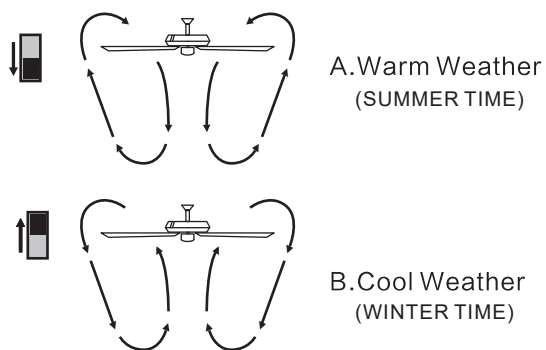

NOTE: Wait for the fan to stop before reversing the direction of the blade rotation

- A. Warm weather-(Forward) A downward airflow creates a cooling effect. This allows you to set your air conditioner on a higher setting without affecting your comfort.
- B. Cool weather-(Reverse) An upward airflow moves warm air off the ceiling. This allows you to set heating unit on a lower setting without affecting your comfort.

REMOTE CONTROL SETTING AND OPERATION

1. Restore electricity to the outlet box by turning the electricity on at the main fuse box.
2. Remove the battery cover from the remote control transmitter, install the battery, and replace the cover.

- Note: 1).** Use two 1.5V battery to replace original one
2). If not used for a long period of time, remove the battery to prevent damage to the remote transmitter, and store the remote transmitter away from excess heat or humidity.
3. Remote control's functions are as follows, including controlling transmitter, fan speed and light.

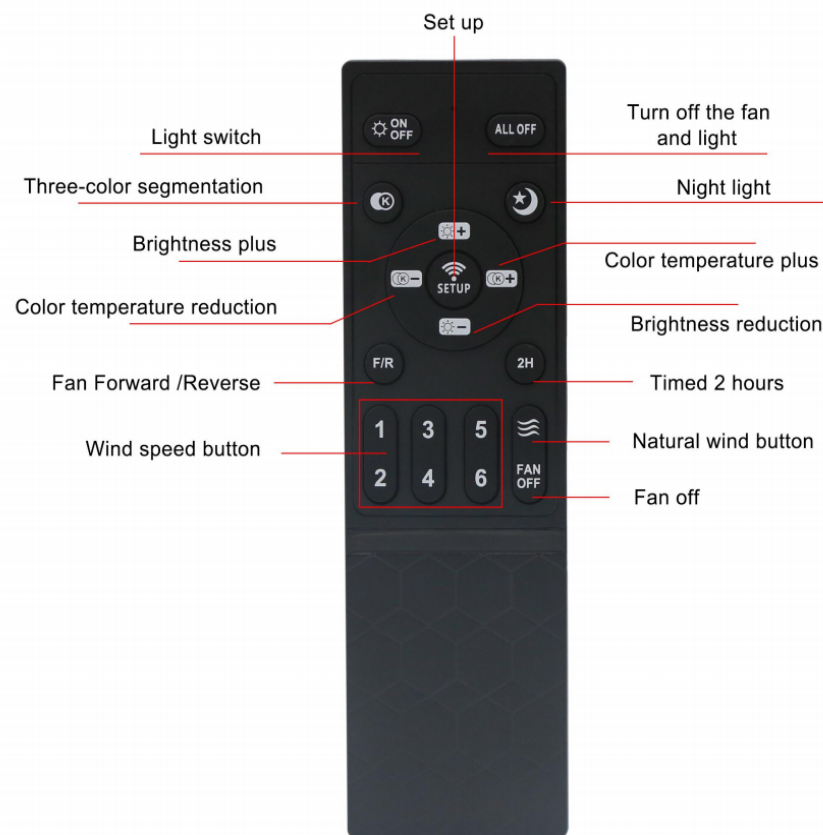

IMPORTANT:PAIRING BETWEEN REMOTE AND RECEIVER

The way to set up: Turn off the power switch or wall switch, Within 3 seconds after power on, press the setup button three times in succession, the light flashes to indicate successful set up.

Clear match : Turn off the power switch or wall switch, press and hold the "SETUP" button and do not let it go, then turn on the power switch or wall switch, and let it go after hearing the beep, unset up is successful.

IMPORTANT NOTES

The first step of pairing must be performed within 30s after turning on the power supply.

- 1.(a)When pairing multiple fans, please ensure the isolation switch or the power supply to the first installed fan is turned off prior to pairing further fans. Please pair one fan at a time. (b)Please ensure the isolation switch is kept "ON". The isolation switch can not act as a light switch as this will impair the remote receiver.
- 2.When the transmitter's functions are disabled, please check the battery orientation and power level. Low battery voltage will affect your transmitter's functions and your fan's operation.Other remote controls nearby using the same frequency may interfere with your fan's receiver.
- 3.Please remove batteries from the transmitter if not used for a long period of time.
- 4.Remote supports 200w maximum lighting.

IMPORTANT REMINDERS

- 1.Note: Receiver must be correctly installed on the fan's mounting bracket.
- 2.When the transmitter cannot control the receiver, please check the battery level.
- 3.When the transmitter cannot control the receiver, please check if similar remote controls your fan nearby and interferes with each other.
- 4.Battery's low power will affect the transmitter's sensitivity and the signal reception accordingly. You must replace the battery if its power is low.
- 5.Please take the battery out of the transmitter to avoid battery leaks when not used for a long time.
- 6.Isolation switch must be connected in the line.
- 7.When a blackout or otherwise circumstances happen, the light will work normally after the power restores.

Please make sure that the fan is powered off before cleaning or maintaining. LED lights are not removable or replaceable, they can only be used with the product.

⚠ WARNING: TO REDUCE THE RISK OF PERSONAL INJURY, DO NOT BEND THE BLADE ARM WHILE INSTALLING, BALANCING THE BLADES, OR CLEANING THE FAN. DO NOT INSERT OBJECTS BETWEEN ROTATING FAN BLADES.

NOISE: This is normal to hear occasional small noises, when it is quiet (especially at night). Because slight power fluctuations and frequency signals superimposed in the electricity for off-peak hot water control may change fan motor noise. Please allow a 24-hour "breaking-in" period, most noises of a

Maintenance and Cleaning

- 1.Check the support connections, brackets, and airfoil attachments twice a year to ensure they are secure, because some connections may loose over time. It is not necessary to remove the fan from the ceiling.
- 2.Clean your fan periodically. Use only a soft brush or lint-free cloth to avoid scratching the finish. The plating is sealed with a lacquer to minimize discoloration or tarnishing.
- 3.(Optional) Apply a light coat of furniture polish to the wood blades.
- 4.(Optional) Cover small scratches with a light application of shoe polish.

Do Not

- 1.Don't use water to clean. Water may damage the motor and the wood, or even possibly cause an electrical shock.
 - 2.Don't apply oil to your fan or motor, as the motor has permanently lubricated sealed ball bearings.
- Note: Power off the fan before maintaining or cleaning the fan.

HOW TO USE BALANCING KITS

NOTE: CEILING FANS TEND TO MOVE DURING OPERATION DUE TO THE FACT THAT THEY ARE MOUNTED ON A RUBBER CROMMET. IF THE FAN WAS MOUNTED RIGIDLY TO THE CEILING, IT WOULD CAUSE EXCESS VIBRATION, MOVEMENT OF A FEW CENTIMETERS IS QUITE ACCEPTABLE AND DOES NOT SUGGEST ANY PROBLEMS

TO REDUCE FAN WOBBLE: PLEASE CHECK THAT ALL SCREWS WHICH SECURE THE MOUNTING BRACKET AND DOWNROD ARE SECURE

BALANCING A WOBBLING CEILING FAN

For your convenience, a balancing kit is included: please follow this procedure when balancing the fan:

1. Check that all blades and blade arm screws are secure.
2. Most fan wobbling problems result from blade levels are unequal. Check this level by selecting a point on the ceiling above one fan blade's tip. Measure this distance. Rotate the fan until the next blade is positioned for measurement. Repeat for each blade. The distance deviation should be equal within 1/8" (0.32cm).
3. Use the enclosed blade balancing kit if the blade wobbling is still noticeable.
4. If the blade wobble is still noticeable, interchanging two adjacent (side by side) blades can redistribute the weight and possibly result in smooth operation.

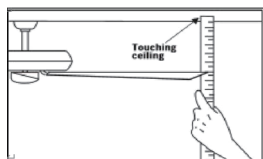

⚠ WARNING: TO REDUCE THE RISK OF PERSONAL INJURY, DO NOT BEND THE BLADE ARM WHILE INSTALLING, BALANCING THE BLADES, OR CLEANING THE FAN. DO NOT INSERT OBJECTS BETWEEN ROTATING FAN BLADES

NOISE

It's normal to hear small occasional noises when in quiet night or days. Please allow a 24-hour "breaking-in" period, most noises of a new fan disappear during the time.

TROUBLESHOOTING

Your fan may occasionally jerk forward or backward upon starting up.

This is normal and does not affect the fan operation.

Try these troubleshooting steps before contacting customer service.

SYMPTOM	POSSIBLE SOLUTIONS
The fan doesn't spin	<ol style="list-style-type: none"> 1. Make sure the fan is getting power. 2. Check the functionality of circuit breaker or fuse panel and wall switch. 3. Confirm fan wires are correctly connected to the house wires. 4. Make sure the blocker of the fan motor is removed. 5. Use your remote to check the power to the breaker and try to work your ceiling fan manually from afar (Normal switch only for the fan power on/off)
The fan's light does not work	<p>Make sure the LED light kit and light bulb are connected well.</p>
The fan is noisy and wobbling	<ol style="list-style-type: none"> 1. Confirm the blade screws are NOT rubbing against the the motor's round plastic part. 2. Confirm the pin wire are NOT connected against the moving part. 3. Confirm the coupling cover is NOT hitting the motor 4. Confirm the down rod is NOT slanted 5. Tighten any loose screws on the light kit, fan blades, motor coupling, down rod, brackets and mounting hardware. 6. Confirm the hanger ball is firmly seated in the mounting bracket. 7. The ceiling beam must meet the minimum tensile test strength of 30KG for installation. 8. Make sure the airfoils and brackets are NOT bent or deformed. 9. Confirm the wire connections are not rattling against each other. 10. Confirm the fan blades are not cracked. If the fan blades are cracked, replace the damaged blades with the set of new blades of same brand as your ceiling fan ensures the compatibility. 11. Change fan blades' positions. 12. Confirm the light kit is NOT slanting and hitting the motor. 13. Confirm all the blades are screwed firmly into blade holders.
The fan or light automatically turns on/off	<ol style="list-style-type: none"> 1. Confirm the circuit breaker is not malfunctioning. 2. Confirm the wire connections are not frayed. 3. Confirm the app does not set the timer or schedule 4. Power off the fan for 10 minutes, then power on again.