

# specifications

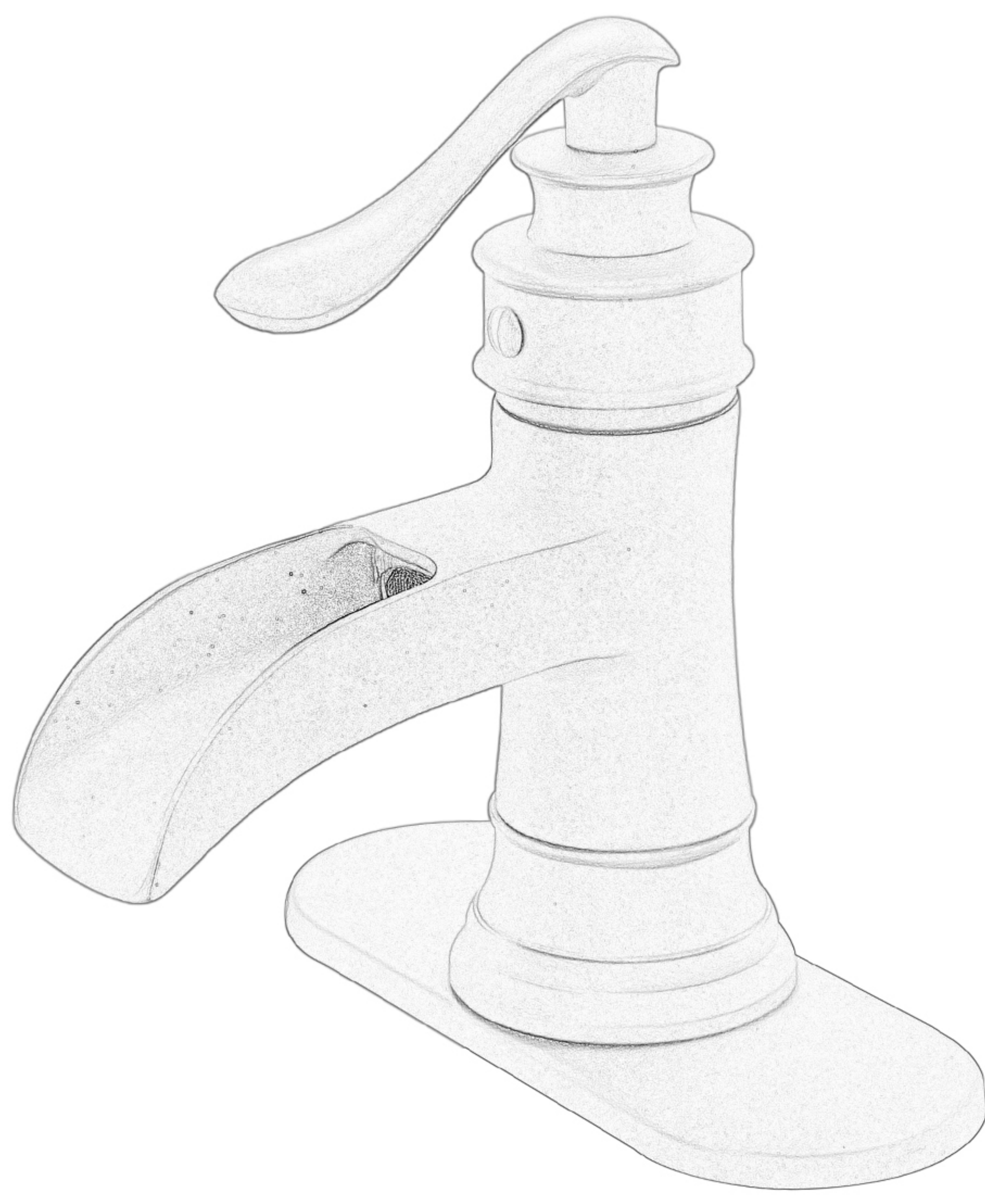

## Single-handle Lavatory Faucet

NOTE : THIS FAUCET IS DESIGNED TO BE INSTALLED THRU 1 HOLE / 3 HOLES.

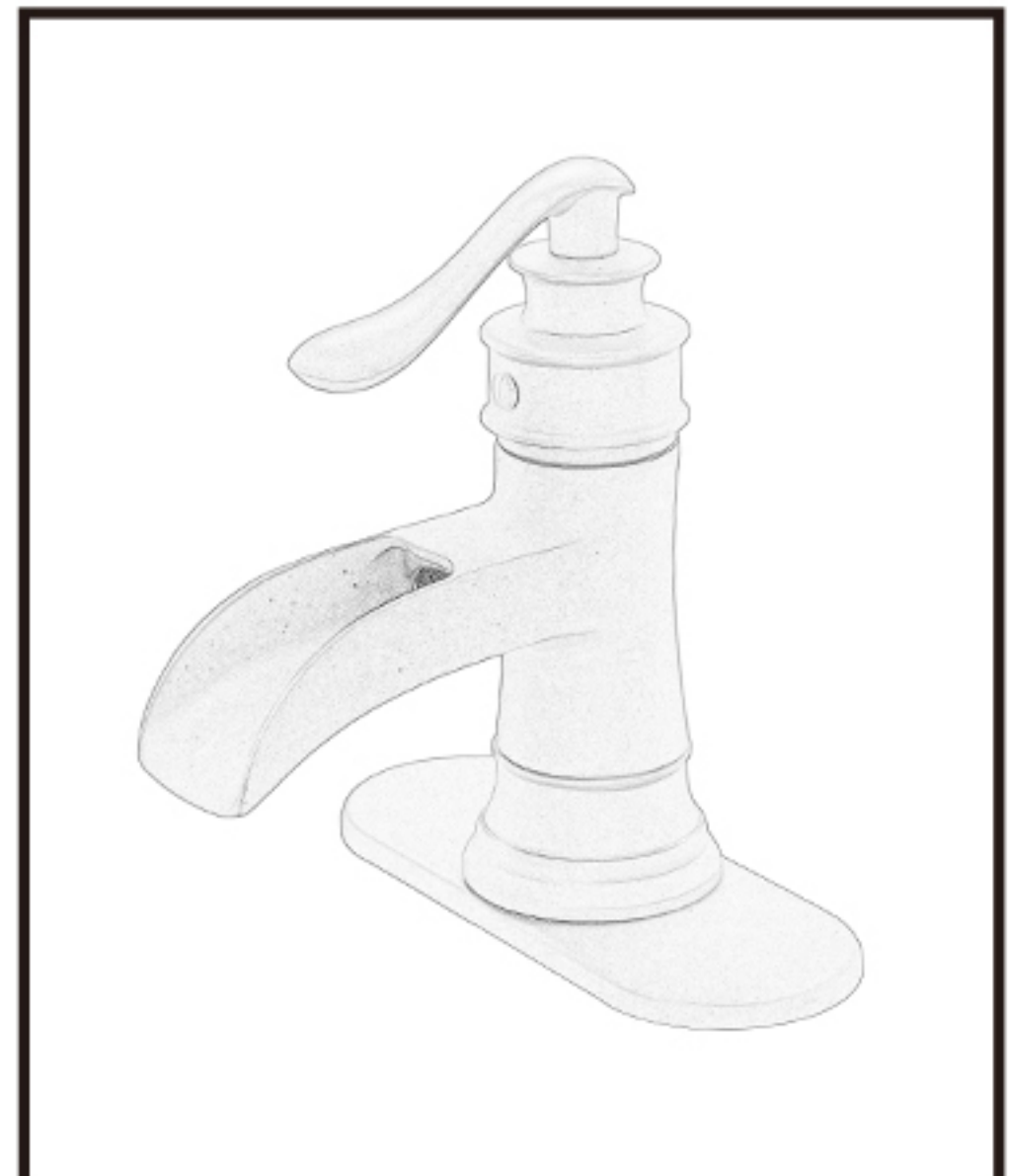

Submitted Model No.: 6556

Specific Features:



## BATHROOM FAUCET

■ Best Water Experience

### Notes before installation:

1. Please check that all components are present.
2. Before installation ensure that all feed lines are clear of debris and on / off valve is present.
3. Ensure water pressure is between 20-125 PSI ( includes combination of hot and cold feed lines ).
4. Pictures in the manual are general in content and may not represent exactly your purchased faucet. If you are having difficulties please contact a professional plumber.
5. If you will be away from home for an extended period you should shut off the main water supply.

### Daily maintenance:

1. Use a soft cloth and vinegar to remove hard-water spots.
2. Check aerator ( if present ) regularly for calcium build up are when water stream is not optimum.
3. DO NOT use caustic cleaning products as the use will break down finish and will void the product warranty.
4. Acceptable cleaners include vinegar or mild non-abrasive liquid detergents.
5. If the water pressure appears to be less than optimum remove, inspect, clean or replace aerator.

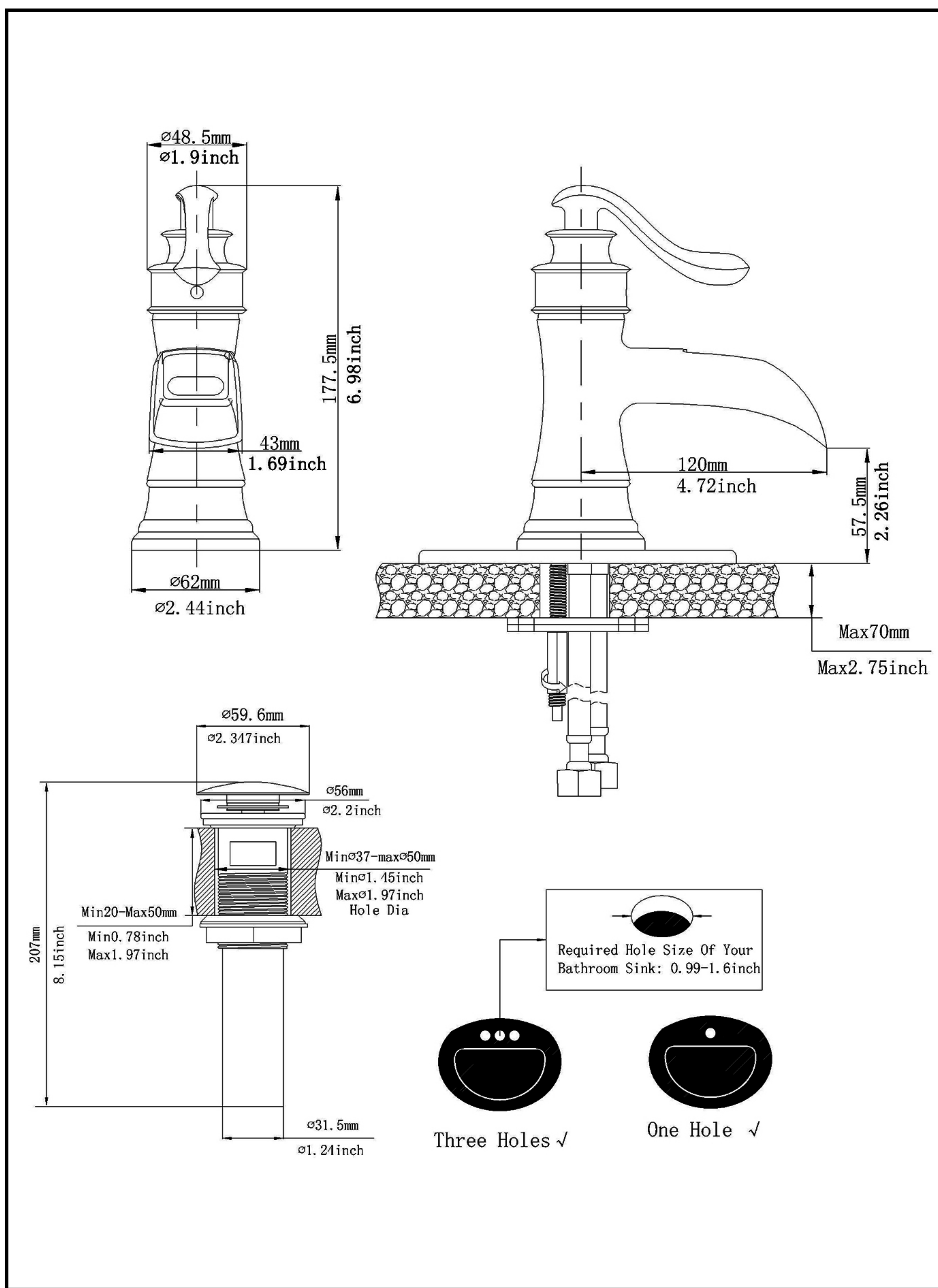

▲ Desianate proper finish suffix

1. Remove the rubber washer , metal washer and locking nut from the faucet.
2. Screw and hand tighten the hot and cold flexible hoses to the faucet . DO NOT use a wrench to tighten hoses as this may damage the hose and / or the hose threads.
3. Install faucet through center hole.
4. Re-install the rubber washer followed by the metal washer and lock-nut. Hand tighten then tighten further using a screw driver to tighten lock-nut screws.

### 1-1 Installation Sketch

With Overflow      Without Overflow

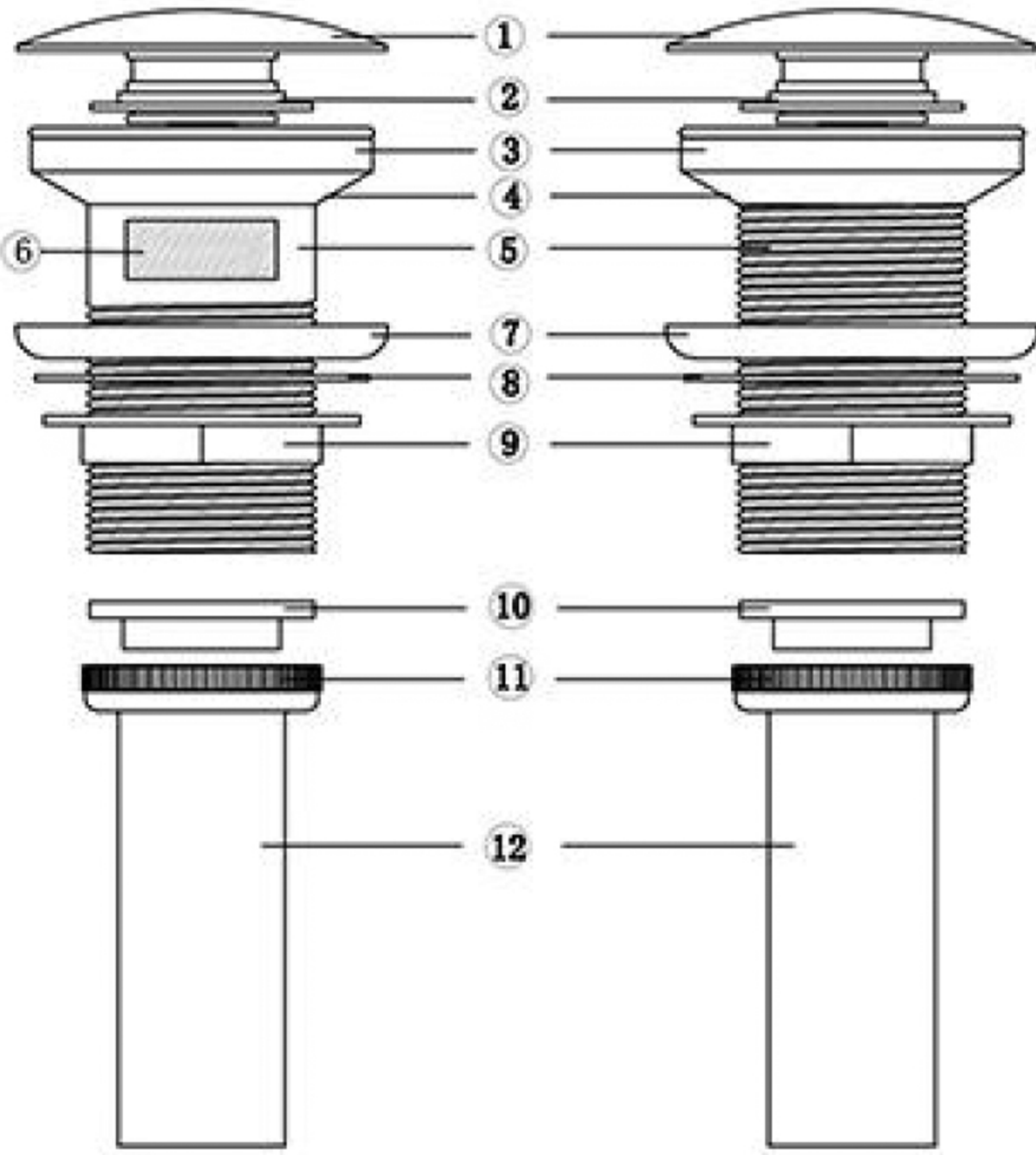

- |                  |                     |
|------------------|---------------------|
| ① Drain Cap      | ⑦ Silicon Gasket    |
| ② Silicon Gasket | ⑧ Plastic Washer    |
| ③ Sponge Gasket  | ⑨ Brass Locking Nut |
| ④ Silicon Gasket | ⑩ Rubber Gasket     |
| ⑤ Drain Bod      | ⑪ Locking Nut       |
| ⑥ Overflow       | ⑫ Tail Pipe         |

### 1-2 Installation Steps

Vessel Sink / Drain Installation (Overflow)

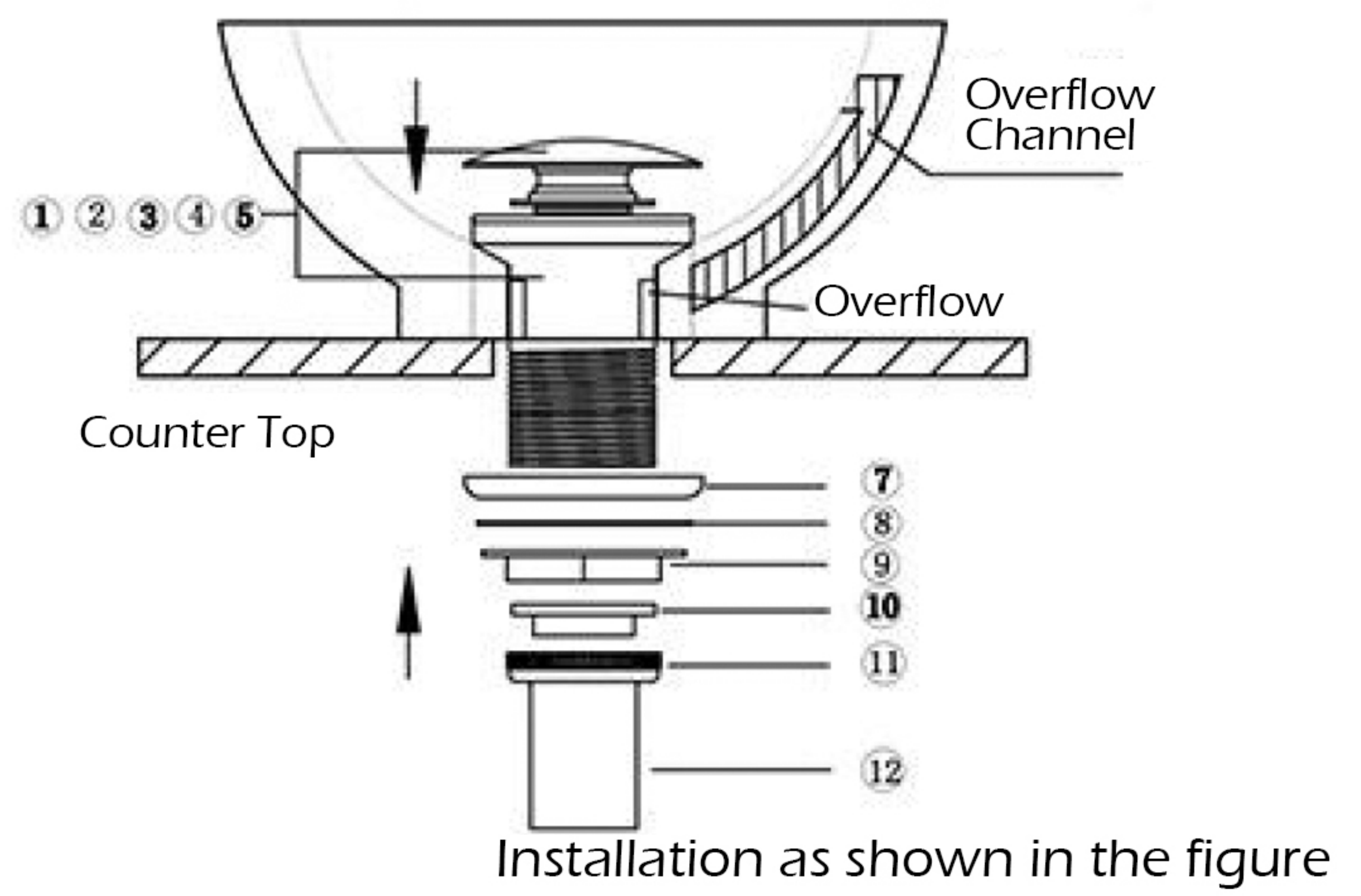

Vessel Sink / Drain Installation (non-overflow)

