

Parts and Damage Replacement Procedure

1. Please inspect your purchase immediately.
2. This procedure covers product purchased from an authorized and was received in its originally sealed carton.
3. If you find a part missing or damaged, you have a 30-day window in which to order a replacement part from the date on your purchase receipt.
4. You have 3 ways to do this. You will need a copy of your purchase receipt.
 - a. By Fax: Fax the parts order form below and along with your receipt.
 - b. By Email: Email the order form and along with your receipt.
 - c. By Mail: Fill out the parts order form below and along with a copy of your receipt send it to
5. Once this order is sent in, you will be notified if the part(s) you are requesting can or cannot be shipped within 7-10 business days.

**A COPY OF YOUR PURCHASE RECEIPT OR INVOICE MUST BE ATTACHED TO THIS ORDER FORM.
NO ORDERS WILL BE PROCESSED WITHOUT PROOF OF PURCHASE.**

NAME: _____
 ADDRESS: _____ (No Post Office Boxes)
 CITY: _____ STATE: _____ ZIP: _____
 PHONE: _____ FAX: _____
 EMAIL: _____

REASON FOR REPLACEMENT/PLEASE CHECK APPROPRIATE BOX.



















- () Damaged /scratched, cracked, broken, crushed, etc.
- () Mechanical malfunction/ drawer glides, swivel mechanisms, lid stays, etc.
- () Missing pieces
- () Unfinished surface
- () Wrong color
- () Other

IF MORE THAN ONE MODEL NUMBER IS LISTED ABOVE, PLEASE SPECIFY THE EXACT MODEL NUMBER OF YOUR ITEM IN THE SPACE PROVIDED BELOW.

Model Number	Part Letter Code	Quantity

ASSEMBLY INSTRUCTIONS

Thank you for purchasing this quality product. Be sure to check all packing material carefully for small Hardware which may have some loose inside the carton during shipment. Identify and count all Hardware. Identify and count all Hardware and compare with the Hardware List Below.

PARTS LIST				HARDWARE LIST				
No.	Description	Sketch	Q'ty	No.	Description	Sketch	Size	Q'ty
A	Headboard Panel		1pc	1	Allen Bolt		Ø5/16"x45mm	8pcs
B	Left/ Right H/B Post		2pcs	2	Spring Washer		Ø5/16"	12pcs
C	Footboard Panel		1pc	3	Flat Washer		Ø5/16"x19mm	12pcs
D	H/B Cross Bar Support		1pc	4	Thread Bolt		Ø5/16"x82mm	8pcs
E	Bed Side Rails		2pcs	5	Cuved Washer		Ø5/16"	8pcs
F	Slats		4pcs	6	Hex Nut		Ø5/16"x18mm	8pcs
G	Slat Support Legs		8pcs	7	Screw		Ø4x32mm	16pcs
H	Right Bun Foot		1pc	8	Open Wrench		Ø5/16"	1pc
I	Left Bun Foot		1pc	9	Allen Key		4mm	1pc
				10	Allen Bolt		Ø5/16"x38mm	4pcs

Step 1:

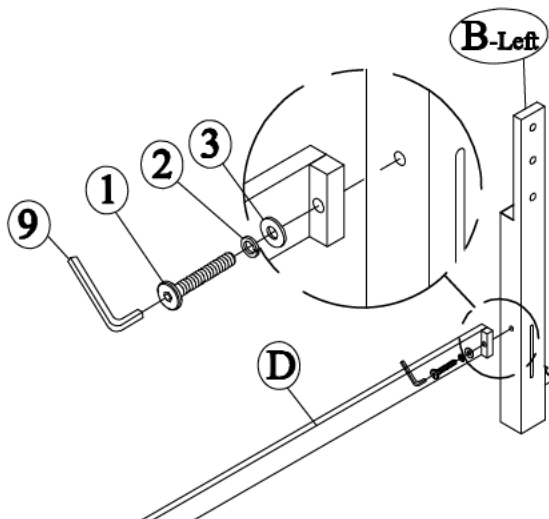

Step 2:

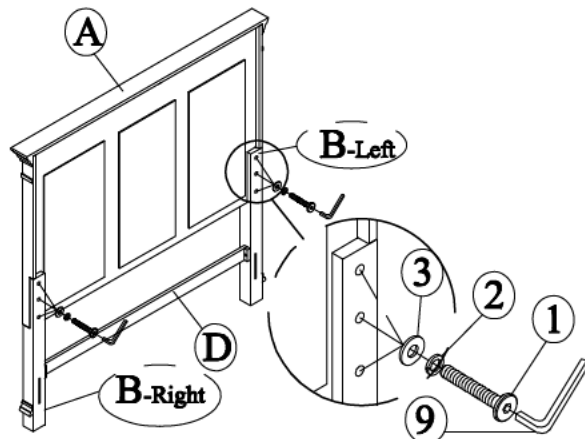

ASSEMBLY INSTRUCTIONS

Thank you for purchasing this quality product. Be sure to check all packing material carefully for small Hardware which may have some loose inside the carton during shipment. Identify and count all Hardware. Identify and count all Hardware and compare with the Hardware List Below.

Step 2:

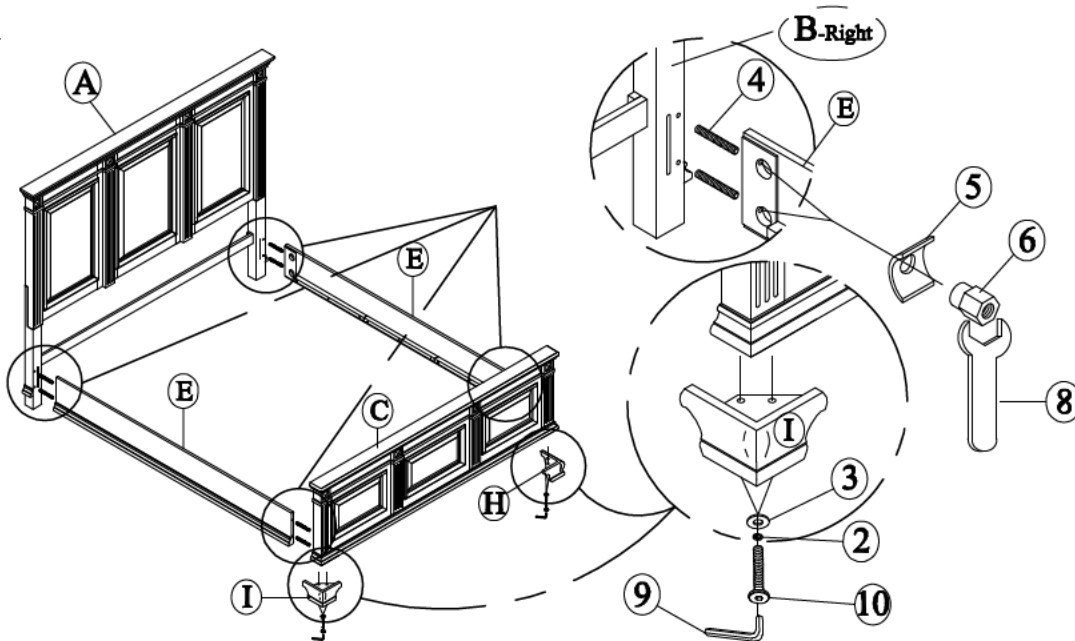

Step 3:

