

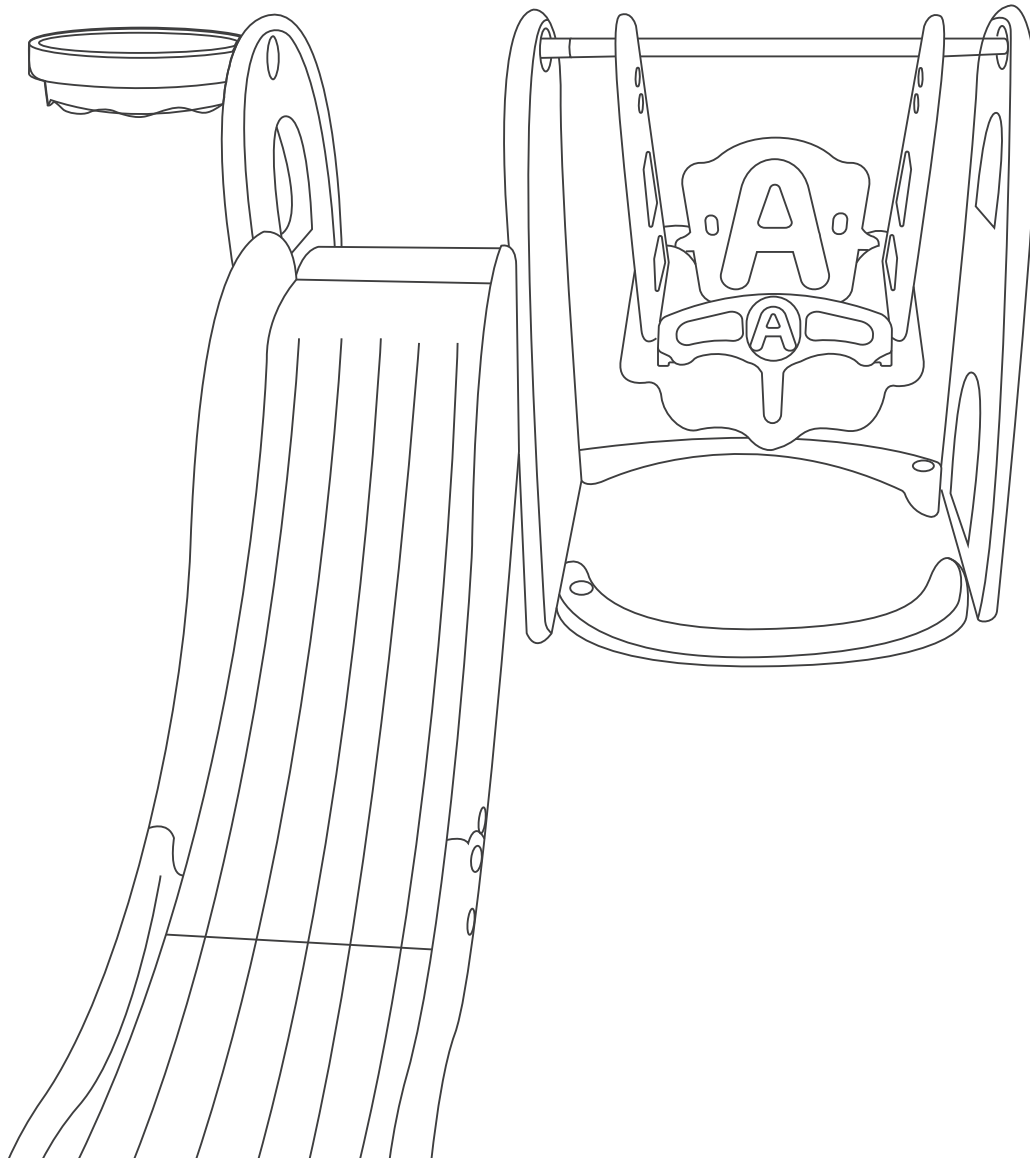

IN240100179V01_US_CA

331-005



INSTRUCTIONS D'ASSEMBLAGE ASSEMBLY INSTRUCTION

EN: **WARNING:** Certification Age: 18+ months; Max weight: 20 kg.

FR: **ATTENTION:** Âge de certification: 18+ mois; Poids maximum: 20 kg.

EN: **IMPORTANT, RETAIN FOR FUTURE REFERENCE: READ CAREFULLY.**

FR: **IMPORTANT: A LIRE ATTENTIVEMENT ET A CONSERVER POUR VOUS Y
REFRERER ULTERIEUREMENT**

WARNING

- Only allowed for adults to install, keep children away.
- To be used under the direct supervision of an adult.
- Keep away from fire! Keep away from water!
- This product contains small parts and a packaging bag inside. Keep away from small children when unassembled.
- Once installed, adult supervision is required when in use.
- This product is for domestic household use. Place safety mats around the equipment when using it. Children must be under adult supervision to ensure safety.
- Maximum load: 20kg.
- Place this equipment on a level surface, at least 2m from walls, fences, electrical wires and other obstructions.
- Ensure there is at least 200mm of space between the swing and floor.
- Do not install this equipment on concrete, asphalt or other hard surfaces.
- Keep away from direct sunlight.
- Keep this manual safe for future reference.
- Do not modify (e.g., adding accessories) this equipment, unless recommended by the manufacturer.

Maintenance

Periodically check the main parts (cross beams, suspensions, anchors, etc) to ensure they are tight and are in good working condition. Follow these steps when checking this equipment:

- a) Ensure all nuts and bolts are tight.
- b) Oil all metallic moving parts to prevent rust.
- c) Check coverings for bolts and sharp edges - replace when needed.
- d) Check swing seats, chains, ropes and other attachments for any damages or deterioration.
- e) Replace defective parts by following the manufacturer's instructions.
- f) Keep all instructions and parts relating to this product for future reference.
- g) If any problem occurred, please sent it to qualified maintainer.
- h) Clean your toy with a clean damp cloth.

AVERTISSEMENT

- Installation par des adultes uniquement, tenir les enfants à l'écart.
- À utiliser sous la surveillance directe d'un adulte.
- Loin du feu ! Loin de l'eau !
- Ce produit présente de petites pièces et un sac d'emballage en son sein. Garder hors de portée des jeunes enfants lorsqu'il n'est pas assemblé.
- Une fois installé, la surveillance d'un adulte est requise lors de l'utilisation.
- Ce produit est destiné à un usage domestique. Posez des tapis de sécurité autour de l'équipement lorsque vous l'utilisez. Les enfants doivent être sous la surveillance d'un adulte pour en assurer la sécurité.
- Charge maximale : 20kg.
- Installez cet équipement sur une surface plane, à au moins 2m des murs, clôtures, fils électriques et autres obstructions.
- Prévoyez un espace d'au moins 200 mm entre la balançoire et le sol.
- N'installez pas cet équipement sur du béton, de l'asphalte ou d'autres surfaces dures.
- Tenir à l'écart de la lumière directe du soleil.
- Conservez ce manuel en lieu sûr pour vous y référer ultérieurement.
- Ne modifiez pas (par exemple, en ajoutant des accessoires) cet équipement, sauf si cela est recommandé par le fabricant.

Entretien

Inspectez périodiquement les pièces principales (traverses, suspensions, ancrages, etc.) afin de vous assurer qu'elles sont bien serrées et qu'elles sont en bon état de fonctionnement. Procédez comme suit lorsque vous vérifiez cet équipement :



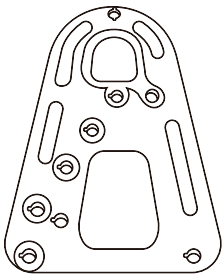

- a) Assurez-vous que tous les écrous et les boulons sont bien serrés.
- b) Huiler toutes les pièces métalliques mobiles pour éviter la rouille.
- c) Vérifiez l'absence de boulons et d'arêtes vives sur les revêtements - remplacez-les si nécessaire.
- d) Vérifiez que les sièges de balançoire, les chaînes, les cordes et les autres accessoires ne sont pas endommagés ou détériorés.
- e) Remplacer les pièces défectueuses en suivant les instructions du fabricant.
- f) Conservez toutes les instructions et les pièces relatives à ce produit pour pouvoir vous y référer ultérieurement.
- g) Si un problème survient, veuillez l'envoyer à un technicien qualifié.
- h) Nettoyez votre jouet avec un chiffon propre et humide.

PACKING DETAILS: TOTAL 2 BOXES



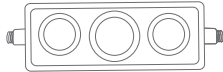
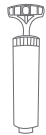

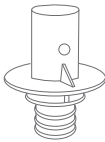
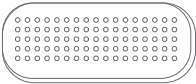

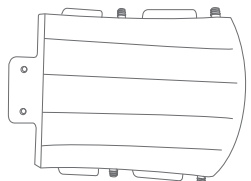
BOX-1/2

NO.	PARTS	QTY
L		3

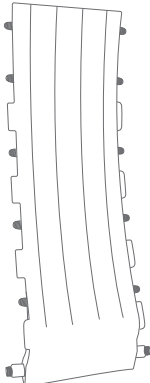
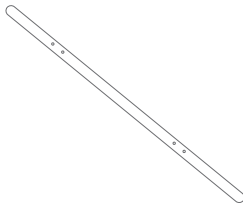
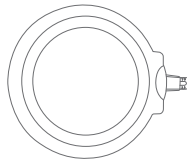

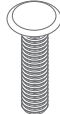
BOX-2/2

NO.	PARTS	QTY
G		4
H		1
I		2
J		2
K		1
M		2
N		2
O		1

BOX-2/2

NO.	PARTS	QTY
P		1
Q		1
R		1
S		1
T		2
U		22
V		18
W		2

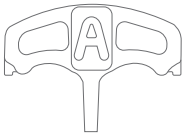
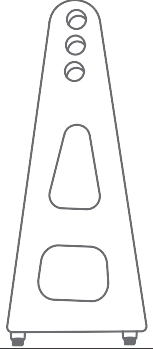
BOX-2/2

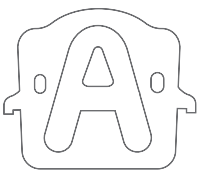
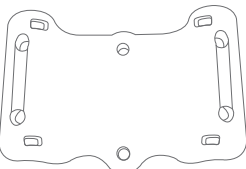
NO.	PARTS	QTY
A		3
B		1
C		2
D		6
E		1
F		1

A x 2+1



C x 2

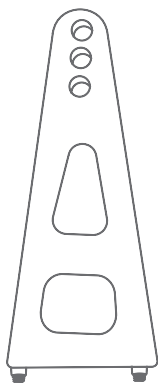

D x 4+2



B x 1

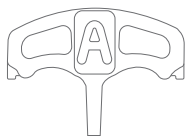

E x 1

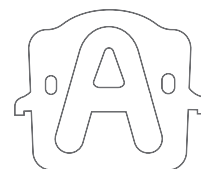

F x 1

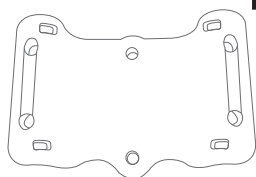

G x 4

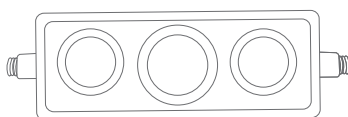

H x 1



I x 2



J x 2

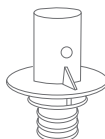

K x 1

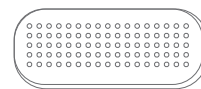

L x 3

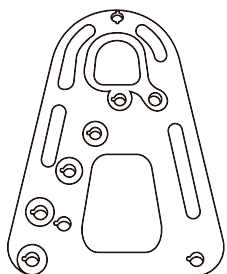

M x 2

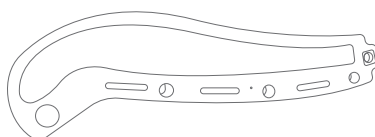

N x 2



O x 1

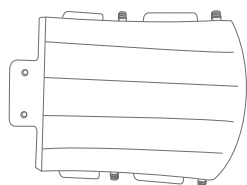

P x 1

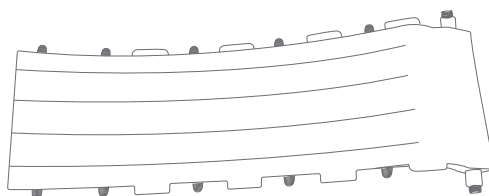

Q x 1



R x 1

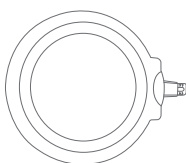

S x 1



T x 2

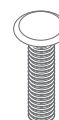

U x 20+2



V x 17+1



W x 2



O x 1

P x 1

T x 2

K x 1

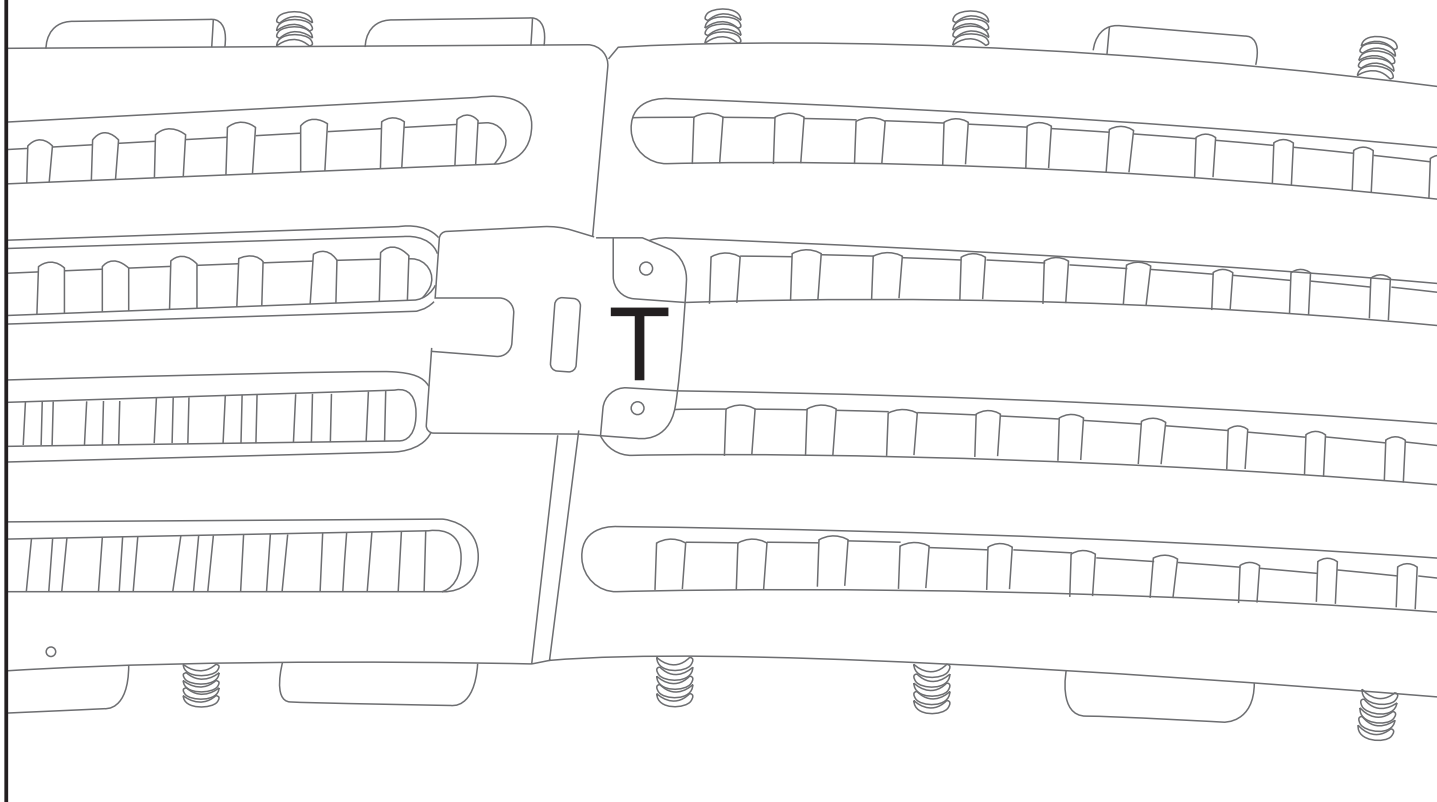

M x 1

N x 1

A x 1

U x 7

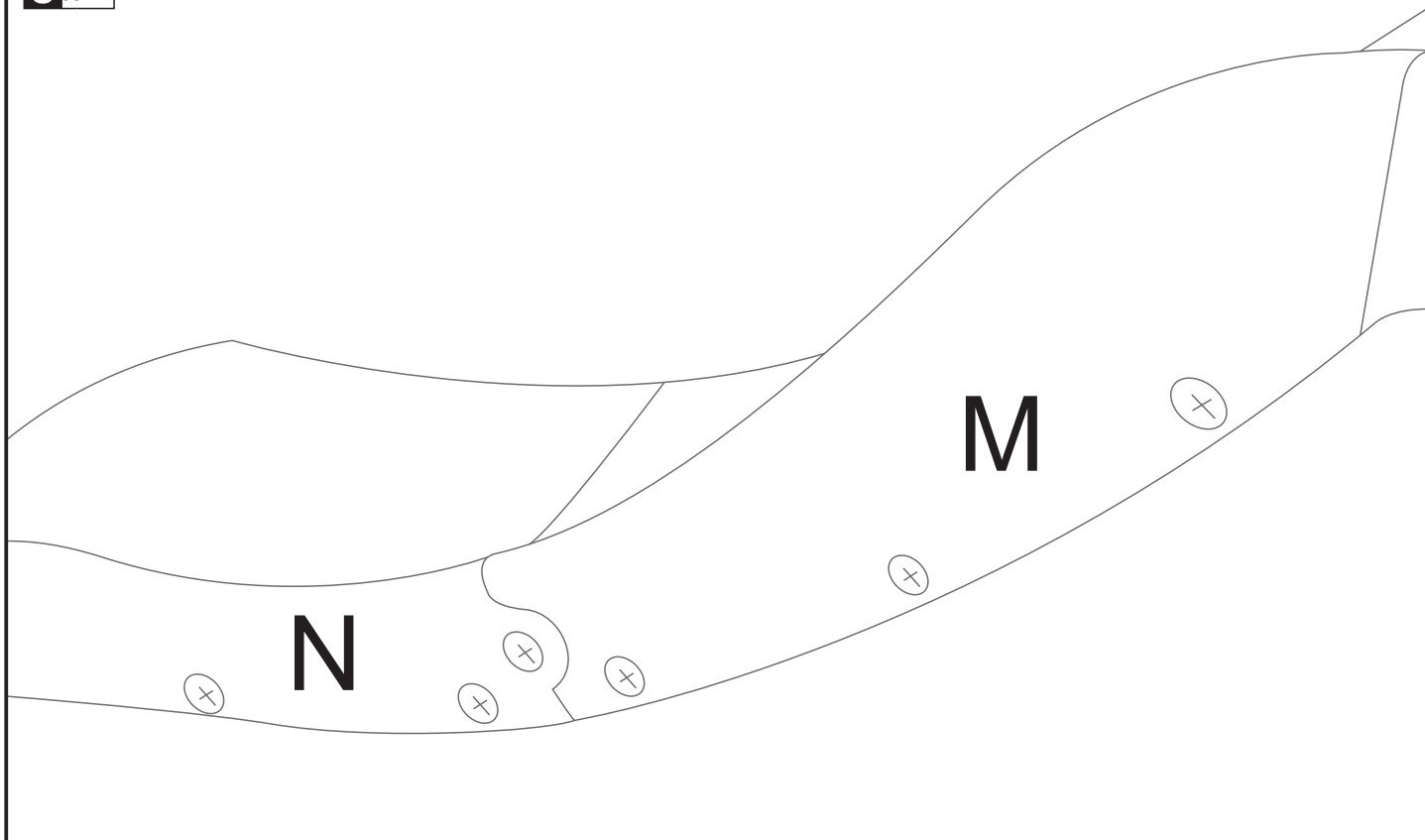

M x 1

N x 1

A x 1

U x 7

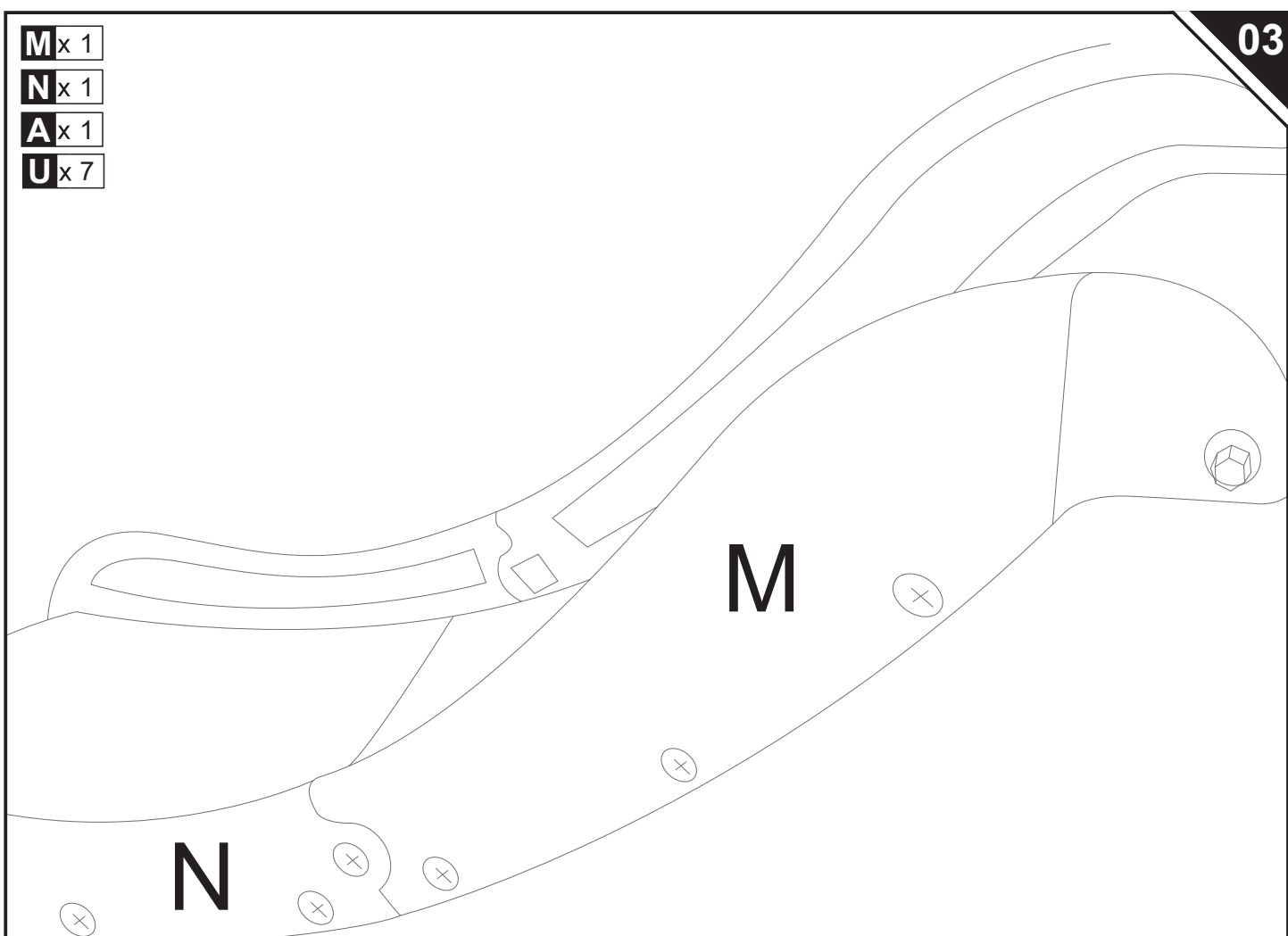

G x 4

L x 1

V x 5

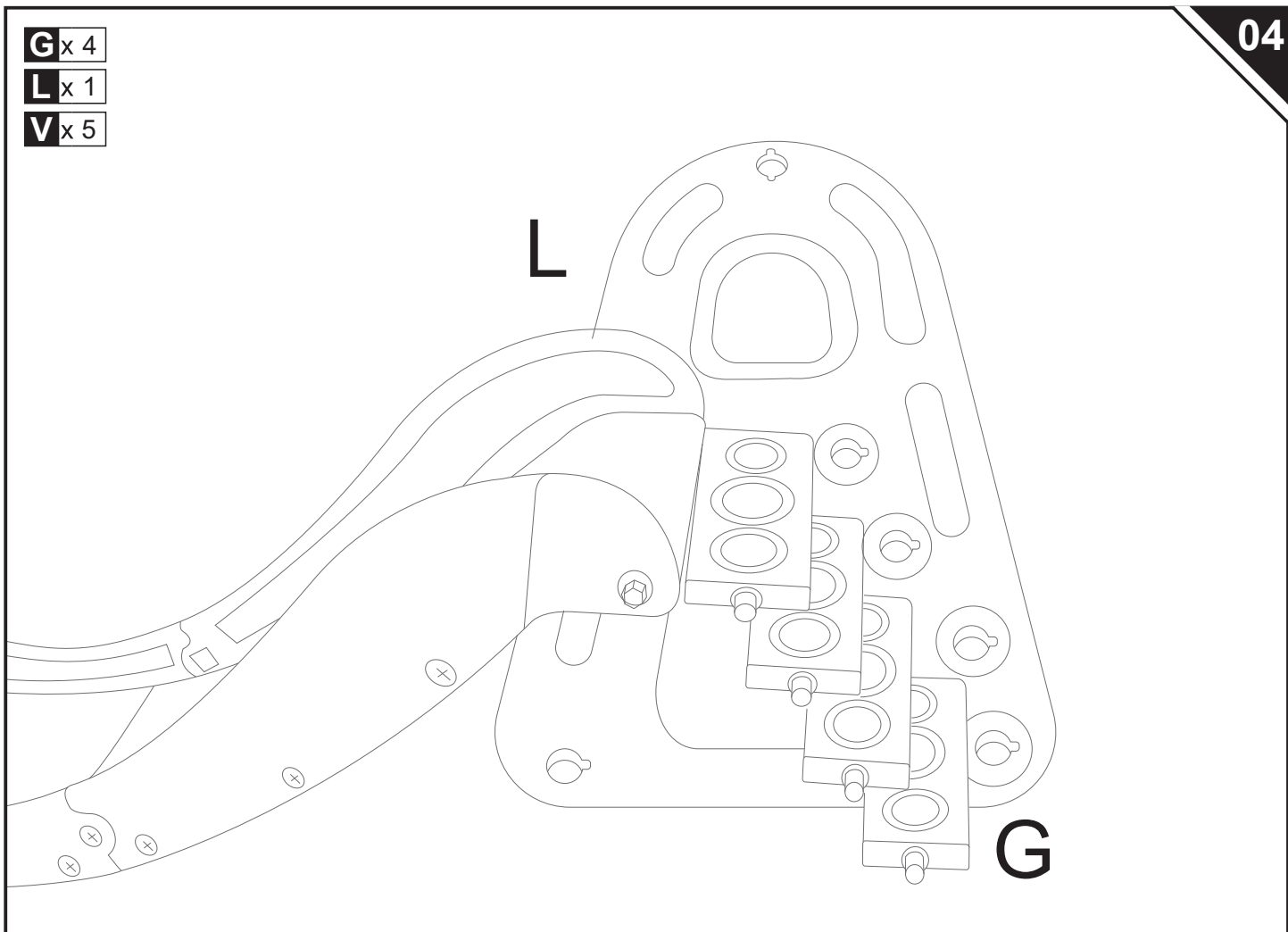

L x 1

V x 5

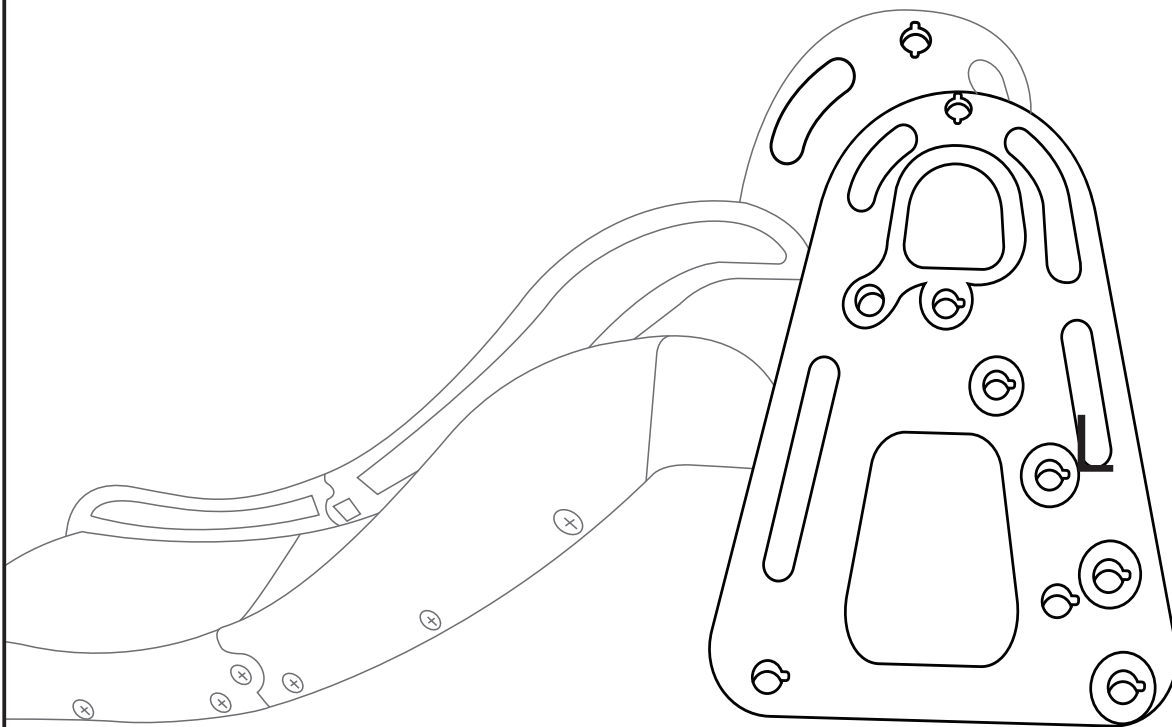

B x 1

C x 2

E x 1

F x 1

U x 6

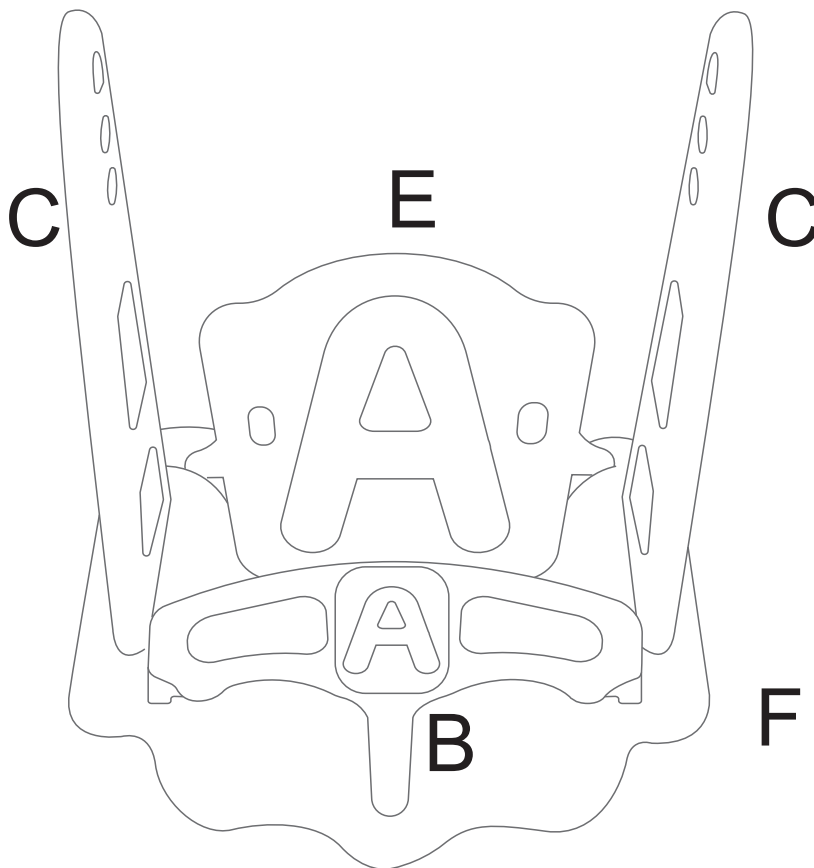

D x 4

J x 2

Q x 1

V x 1

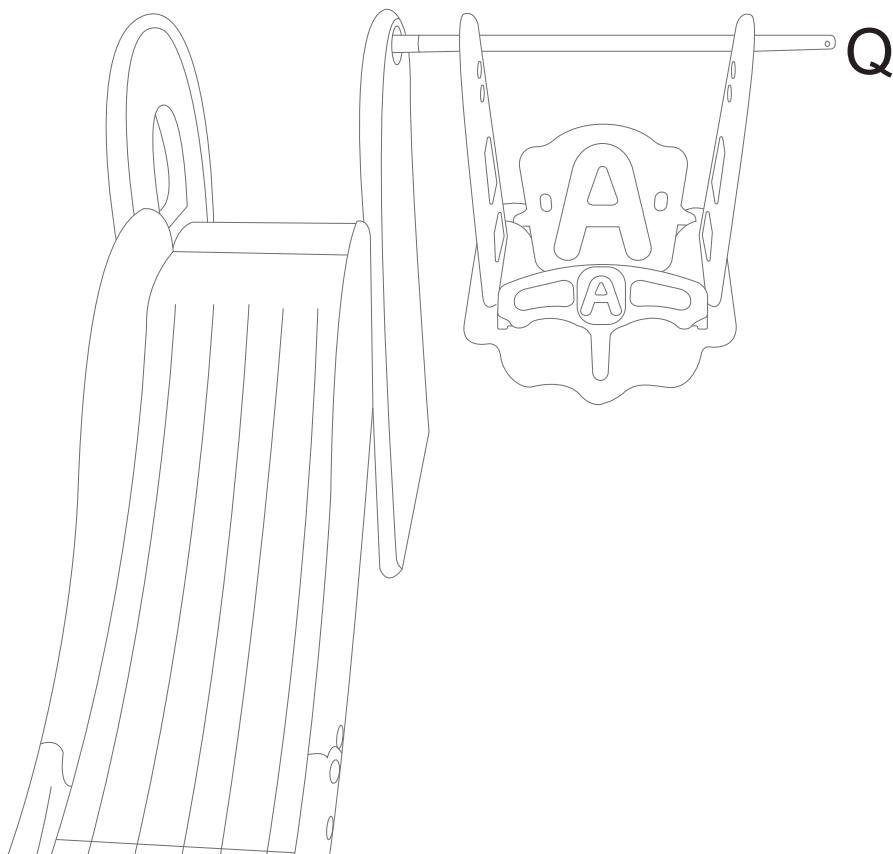

I x 2

W x 2

V x 2

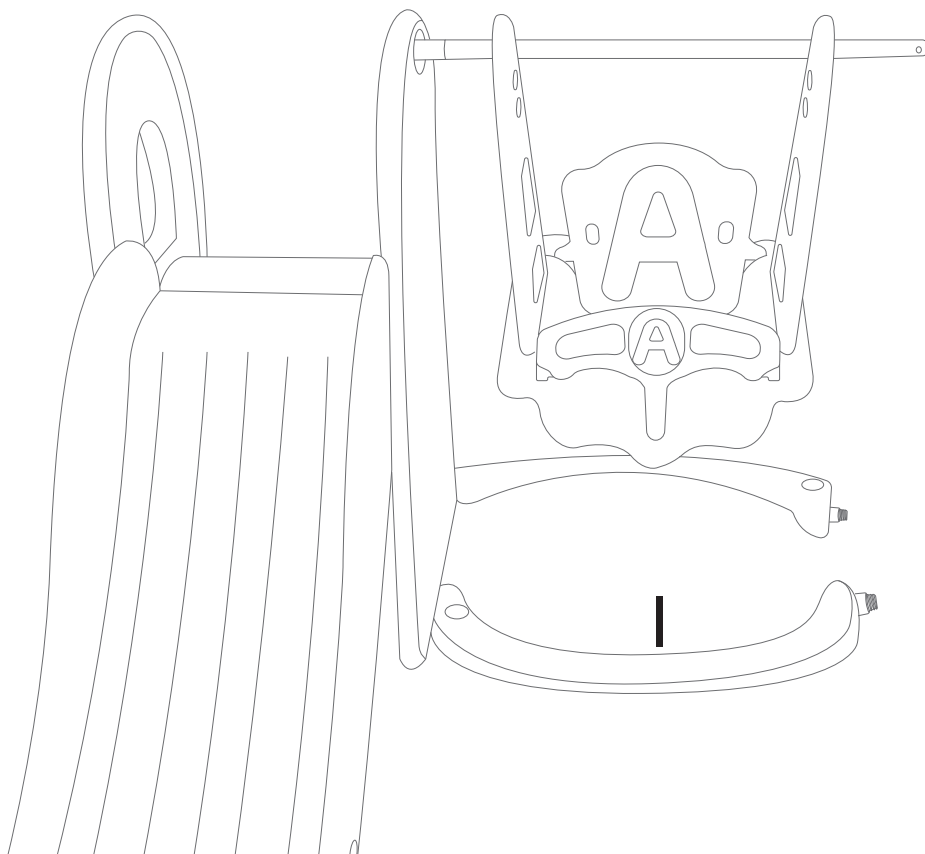

L x 1

V x 4

R x 1

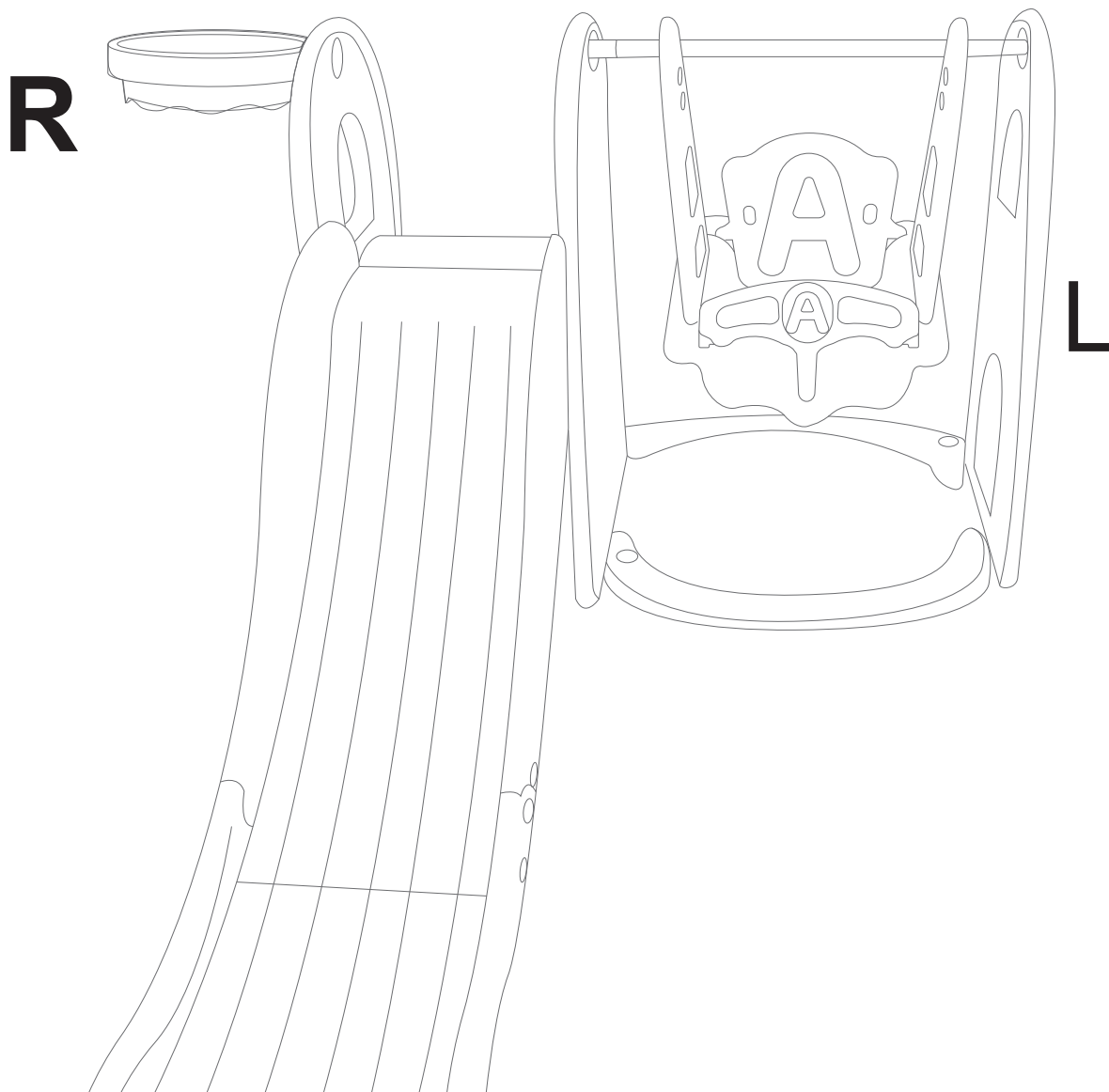

US

If you have any questions, please contact our customer care center.
Our contact details are below:



001-877-644-9366



customerservice@aosom.com

Imported by Aosom LLC
27150 SW Kinsman Rd Wilsonville, OR 97070 USA
MADE IN CHINA

CA

If you have any questions, please contact our customer care center.
Our contact details are below:

Si vous avez la moindre question, veuillez contacter notre centre d'assistance à la clientèle.
Nos coordonnées sont les suivantes:



416-792-6088



customerservice@aosom.ca

Imported by Aosom Canada Inc.
7270 Woodbine Avenue, Unit 307, Markham, Ontario Canada
L3R 4B9
MADE IN CHINA

Importé par Aosom Canada Inc.
7270 Woodbine Avenue, unité 307, Markham, Ontario Canada
L3R 4B9
FABRIQUÉ EN CHINE