

ASSEMBLY INSTRUCTIONS

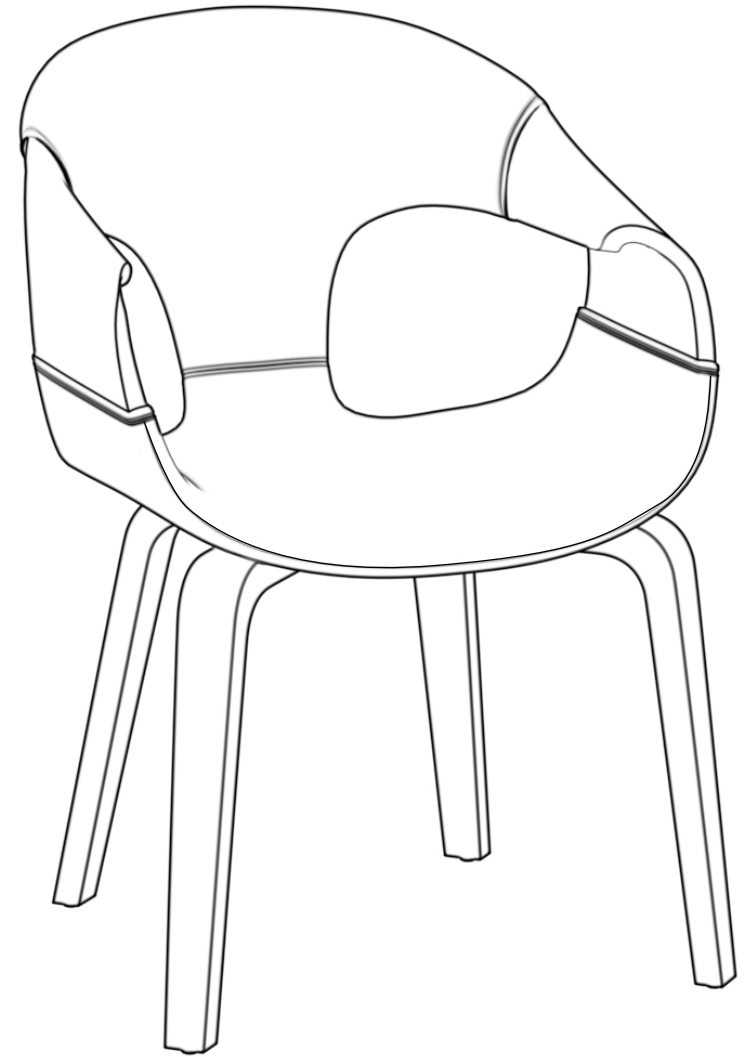

DINING CHAIR

Be sure to keep spare parts.

**If screws or nails of a product are damaged or lost,
or screws or nails of a subsequent product are
damaged or aged, spare parts can be used to replace them.**

1

Ax1



Bx1

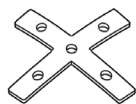

Dx1

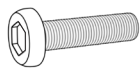

Ex5

Please install 4 screws **E** to **50%** in sequence

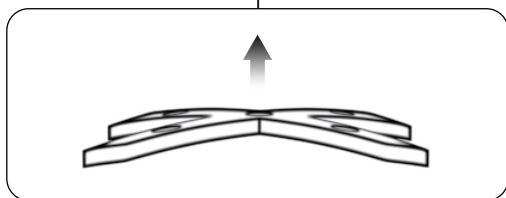
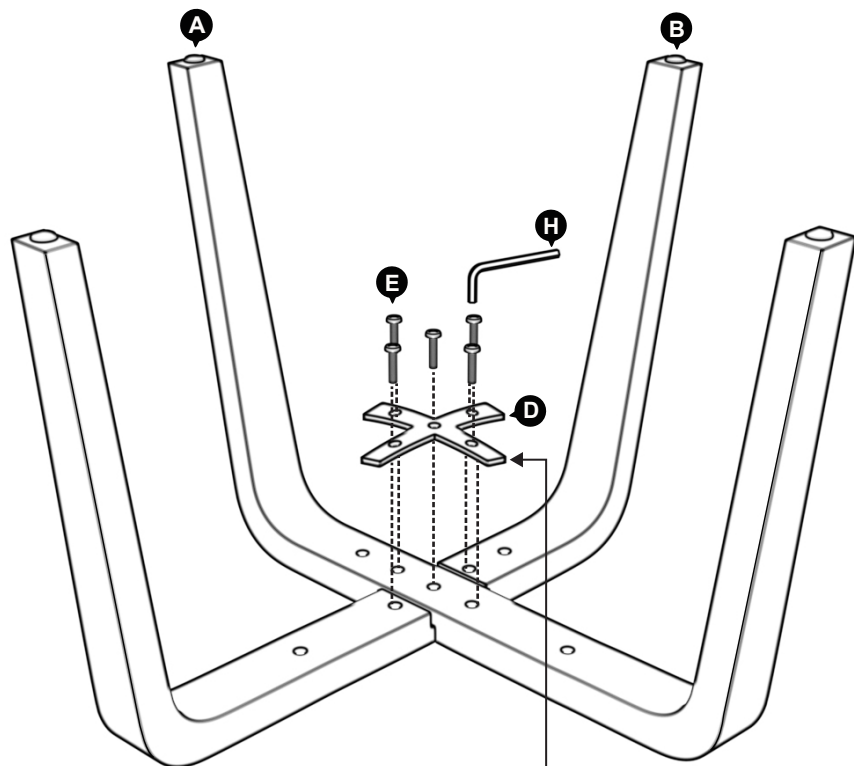

Note: This side is facing up!

2

Cx1

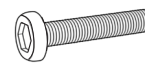

Fx4



Gx4

Please install 4 screws **A** to **50%** in sequence

After installing the screws in **Step 1** and **Step 2**
tighten the screws to **100%**

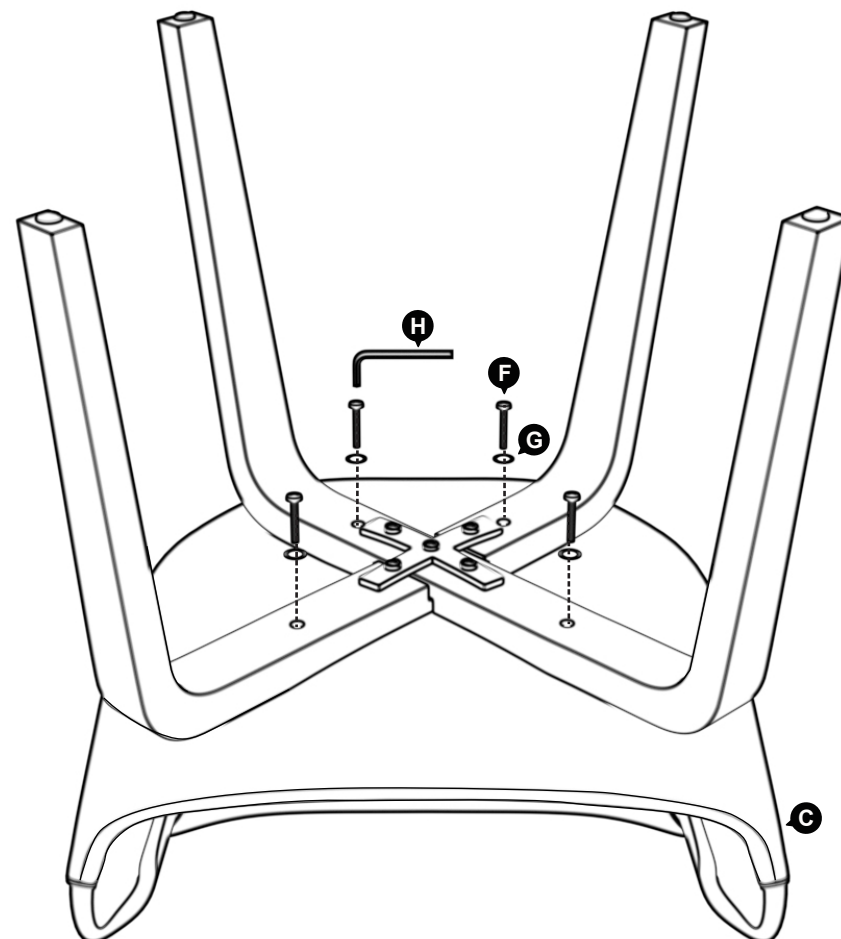

If you feel that the chair is not balance you can adjust the foot nails to level according to your needs

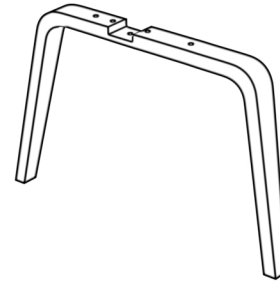
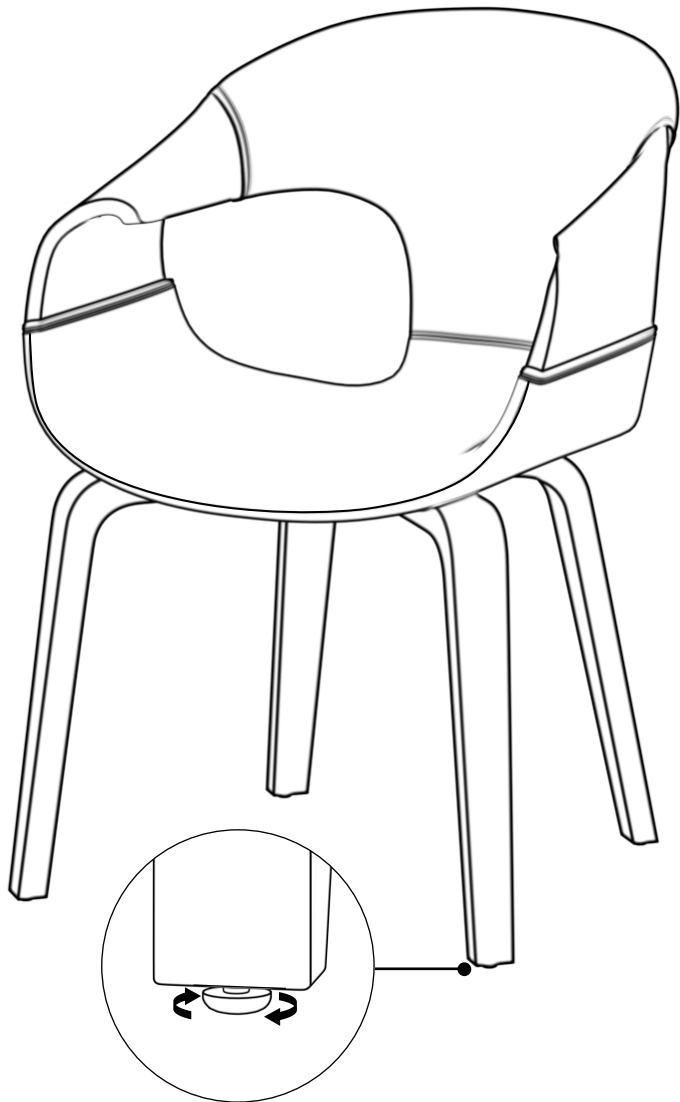

Ax1

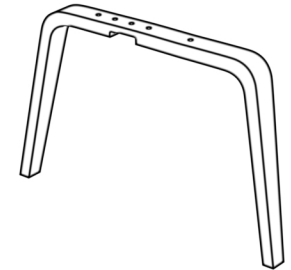

Bx1

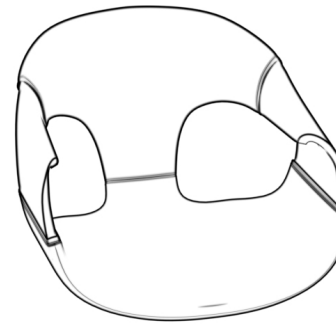

Cx1

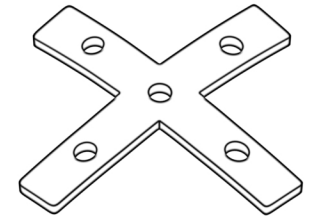

Dx1

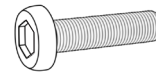

Ex5+1extra
(M6*35mm)

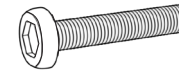

Fx4+1extra
(M6*40mm)



Gx4



Hx1