

Adjustable Sliding Door and Window Security Lock Bar (Chrome)

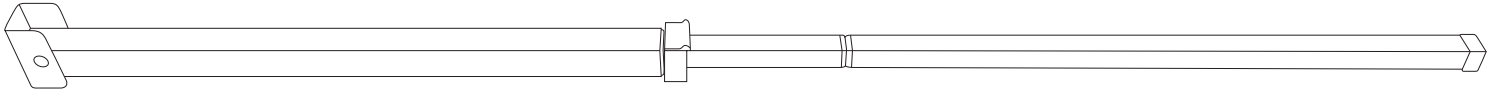

Introduction

The SecurityMan SECURITYBARPC is a heavy duty security bar made from high grade iron that can secure just about any patio sliding door. The SECURITYBARPC is fully adjustable with an easy to use drop down arm that assures full contact when in place.

Features

- Heavy duty security bar for sliding doors and windows
- Add extra security to your patio doors and windows
- Adjustable between 19" to 51"
- Anti-lift lock kids prevention
- Easy to use

Package Contents

- SECURITYBARPC
- Extension bar
- Lift lock (2 parts; metal plate & chrome saddle mount)
- Threaded screw rod (for extending the bar)
- 2x End caps (black, plastic)
- 2x Threaded end caps (for extending the bar)
- 5x flathead screws
- QSG

Specifications

- Application: For sliding patio doors and windows
- Adjustable length: 19" to 51" inch (19" to 33.25" on 2 bars, 36.5" to 51" on 3 bars)
- Size: Outer bar 1.0" x 1.0" / inner bars .75" x .75" inner (2 parts)
- Anti lift lock: Yes
- Force: 350lbs max pressure
- Gauge: 1/16" (thickness)
- Material: High grade iron tube
- Color: chrome
- Weight (net / gross): 1.90lbs / 2.90lbs

Product basics

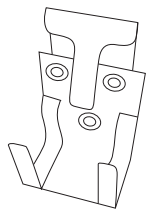
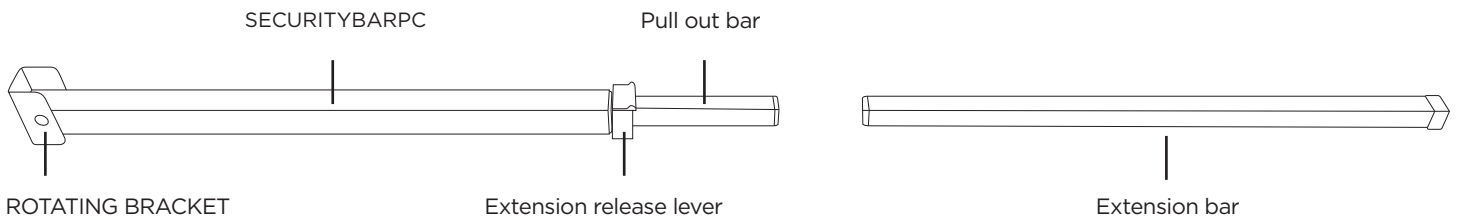

Lift lock: Metal plate & chrome saddle mount

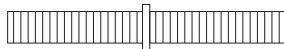

Threaded screw rod (for extending the bar)

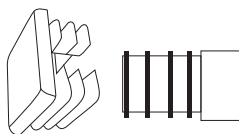

2x End caps

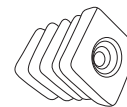

2x Threaded end caps (For extending the bar)



5x Flathead screws

Setup

Before you begin drilling holes please measure the distance of the door/window opening and determine whether or not you need to add the extension bar to the SECURITYBARPC. If the extension bar is needed, attach one end of the pre-drilled end caps to the end of the SECURITYBARPC and then screw the bars together using the threaded screw rod. If the extension is not needed please go ahead and attach the sealed caps to the end of the bar.

1. Place the rotating bracket (Approx. 3ft from the floor for sliding door) against the inside of the sliding door frame and mark where the holes will go. Then drill 1/16" holes and attach bracket to wall using the included screws.
2. Place the opposite end of the bar into the lift lock and saddle catch (lift lock behind the saddle catch), extend the bar to the inside edge of sliding door/window, place a Torpedo Level (not included) on top of the bar to ensure it is level, and then mark where the holes will go. Then drill 1/16" holes and install the screws through saddle catch and Lift lock and into the door.

CAUTION: PLEASE MAKE SURE THAT THE DRILL AND SCREWS DO NOT PENETRATE THE GLASS.

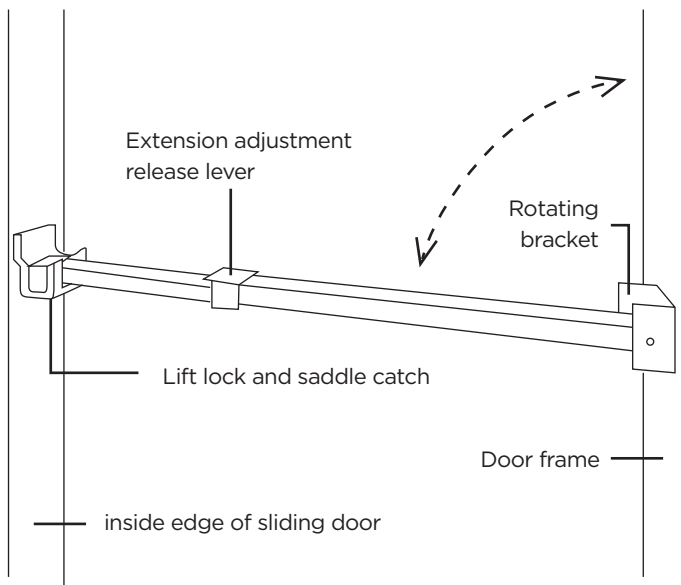

TO STORE

Press the lift lock toward the sliding door/window, lift up the bar and then pivot the bar to a vertical position.

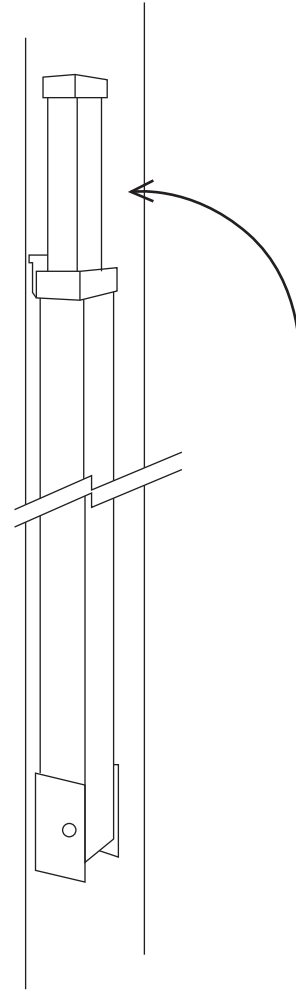

Warranty:

SecurityMan warrants that this product will be free from defects in materials and workmanship for one year or otherwise specified on the product packaging. This limited warranty shall commence from the date of purchase. SecurityMan Products warranty is not transferable and is limited to the original purchaser. If the product is found to be defective then, as your sole remedy and as the manufacturer's only obligation, SecurityMan will repair or replace the product. This warranty shall not apply to products that have been subjected to abuse, misuse, abnormal electrical or environmental conditions, normal wear and tear or any condition other than what can be considered normal use.

Copyright Notice

This manual is furnished under license and may be used or copied only in accordance with the terms of such license. Except as permitted by such license, no part of this publication may be reproduced, stored in a retrieval system, or transmitted, in any form or any means, electronic, mechanical, recording, or otherwise, including translation to another language or format, without the prior written permission of SecurityMan. The content of this manual is furnished for informational use only, is subject to change without notice, and should not be construed as a commitment by SecurityMan. SecurityMan assumes no responsibility or liability for any errors or inaccuracies that may appear in this book. All other product names, trademarks and registered trademarks in this document are the properties of their respective holders.

SecurityMan®

4601 E. Airport Drive, Ontario, CA 91761, USA

Tel: 888-977-3777 or 909-230-6668 Fax: 909-230-6889

Email: info@securitymaninc.com Website: <http://www.securitymaninc.com>

Copyright 2019 by SecurityMan v2.2

If you encounter any difficulty in the operation of this product after reading the manual, please feel free to contact us. You can reach us by phone at 1-888-977-3777 from 8:30 AM to 5:30 PM Monday through Friday (Pacific Standard Time) or by email techsupport@securitymaninc.com. We will be happy to answer your questions and help you in any way we can.

For Customer Service: 888-977-3777