

ASSEMBLY INSTRUCTIONS

30 INCH BATH VANITY (COMBO)

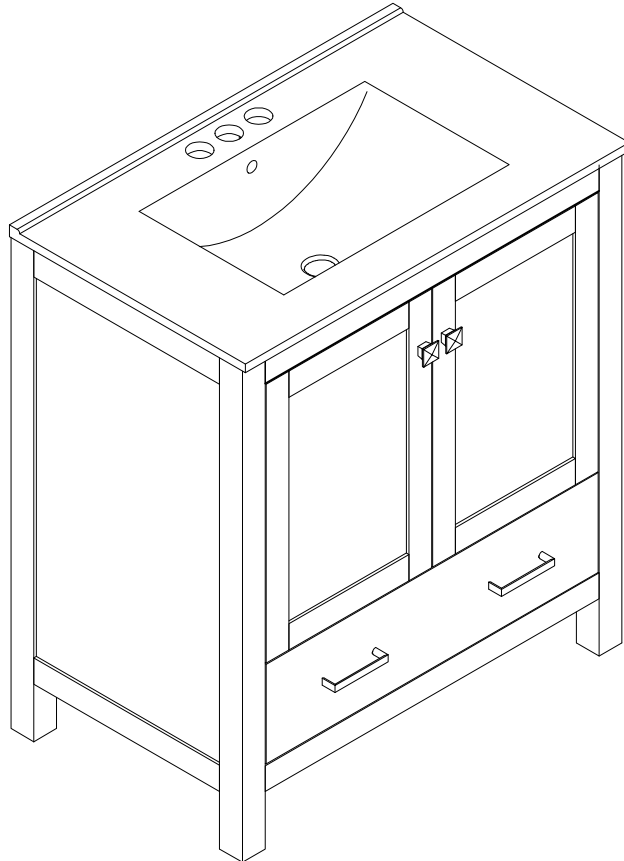

Thank you for purchasing this quality product. Be sure to check all packing material carefully for small parts which may have come loose inside the carton during shipment. Separate, identify and count all parts and hardware. Compare with the parts list to be sure all parts are present.
"DO NOT TIGHTEN SCREWS UNTIL COMPLETELY ASSEMBLED"

*** Use of power tool to assemble this product will invalidate any claim and damage this product making unsafe !!!**
*** Please assemble on a clean soft surface to avoid damage.**

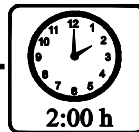
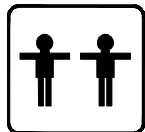

Tools Required

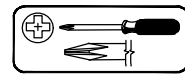

(Not included)

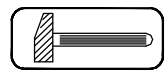

(Not included)

IMPORTANT:

PLEASE READ INSTRUCTION BEFORE STARTING THE ASSEMBLY

Before Installation

Important - Please read these instructions fully before starting assembly

Thank you for purchasing this quality product. Be sure to check all packing materials carefully for small parts, which may have come loose inside the carton during shipment. Identify and count all items according to the PARTS LIST and/or HARDWARE LIST shown below. Check you have all the components and tools listed on the following pages.

- . We recommend that you assemble this product with the assistance of another person; this will make the assembly easier, and will help eliminate damage to the product or injury to persons during assembly.
- . Please do not over tighten screws or bolts until the assembly is completed.
- . Keep children and animal away from the work area, small parts could choke if swallowed.
- . Please put all parts on a non-abrasive floor before assembly, and follow the assembly steps to assemble your newly purchased product correctly and efficiently.

If you find that you have any trouble with assembly or missing or damaged parts please contact the seller.

Cam Lock Assembly Instructions

		Diagram A Insert Cam Bolt into hole as shown in diagram A.
		Diagram B Make sure not to insert the Cam Bolt too deep as shown in figure B as this will cause the Cam Lock to be misaligned and unable to interlock properly.
		Diagram C Also avoid inserting the Cam Bolt too close to the surface of the hole as shown in figure C, as this will cause the Cam Lock to be too loose, and not interlock properly.
		Connect the panels together.
		ARROW SIGN Insert the Cam Lock so the side opening fits over the head of the Cam Bolt.
		To tighten the Cam Lock, turn it clockwise on half a turn with a flat screwdriver. <i>*Do not use an automatic screwdriver as it may bend or break if too much power is imposed.</i>

**Slides Must Be Separated Before Assembly.
After Separated, Set Aside Until Needed for Assembly.**

Las diapositivas deben separarse antes del montaje.
Después de la separación, déjelo a un lado hasta que sea necesario.

Les glissières doivent être séparées avant l'assemblage.
Après la séparation, mettez de côté jusqu'au moment de l'assemblage.

**Pay attention when connecting !
The sliding module must be at the front end.**

**STEP 1 : Extend Slide
Extender la diapositiva**

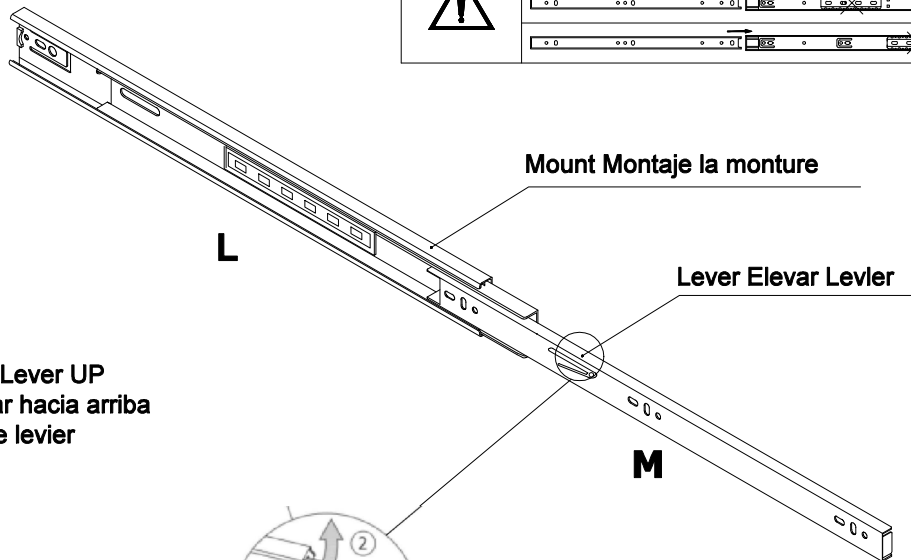
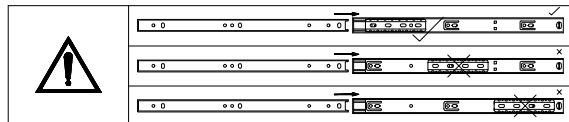

**STEP 2: Push Lever UP
Empujar hacia arriba
Lever le levier**

**Push lever for the left of drawer ,
press the lever for the right of drawer.**

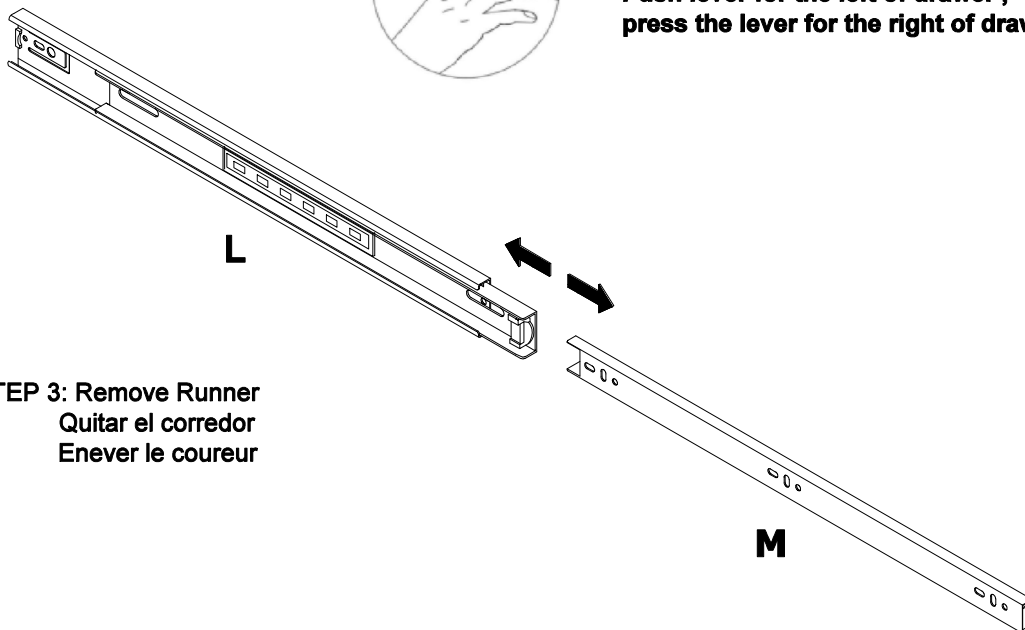



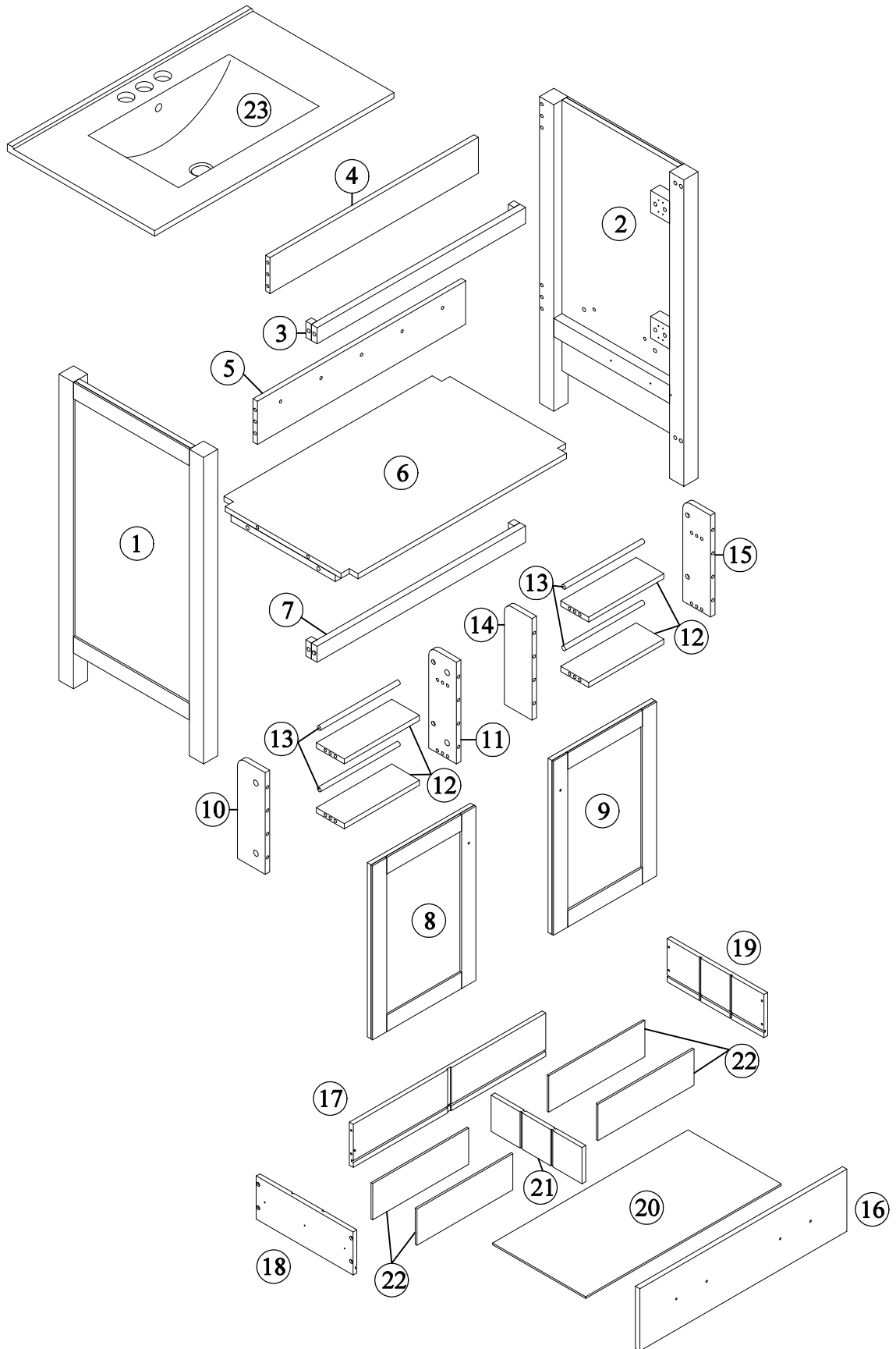

**STEP 3: Remove Runner
Quitar el corredor
Enlever le coureur**

Detail View - CABINET



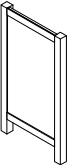
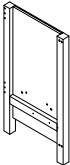
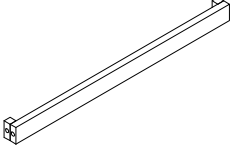
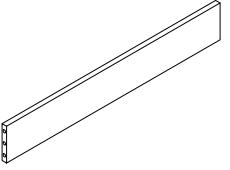
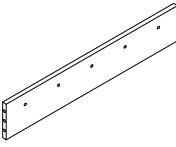
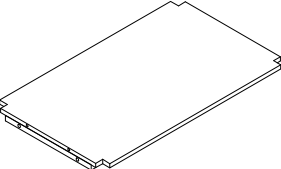
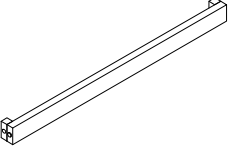
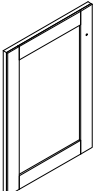
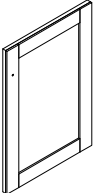
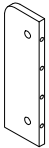

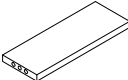
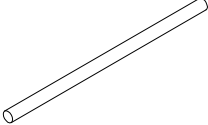
Identifying the Hardware-Identify the hardware using the illustrations below.





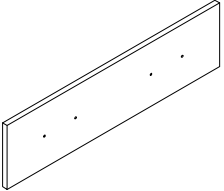
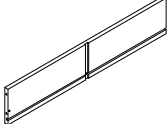

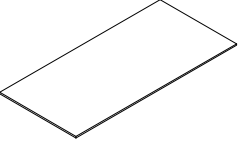
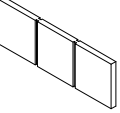
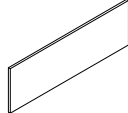
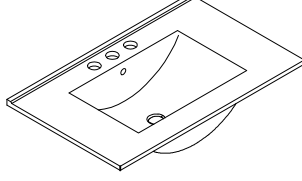

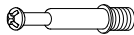

Part List -

<p>1</p>  <p>Side Panel (L) - 1pc</p>	<p>2</p>  <p>Side Panel (R) - 1pc</p>
<p>3</p>  <p>Front Bar Top - 1pc</p>	<p>4</p>  <p>Rear Panel Top - 1pc</p>
<p>5</p>  <p>Rear Panel Bottom - 1pc</p>	<p>6</p>  <p>Frame Mid - 1pc</p>
<p>7</p>  <p>Front Bar Bottom - 1pc</p>	<p>8</p>  <p>Door (L) - 1pc</p>
<p>9</p>  <p>Door (R) - 1pc</p>	<p>10</p>  <p>Panel Left Side Door (L) - 1pc</p>
<p>11</p>  <p>Panel Right Side Door (L) - 1pc</p>	<p>12</p>  <p>Panel Mid Door - 4pcs</p>
<p>13</p>  <p>Round Bar Door - 4pcs</p>	<p>14</p>  <p>Panel Left Side Door (R) - 1pc</p>

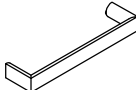
Part List -

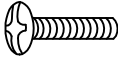
<p>15</p>  <p>Panel Right Side Door (R) - 1pc</p>	<p>16</p>  <p>Drawer Face - 1pc</p>
<p>17</p>  <p>Drawer Rear (L)- 1pc</p>	<p>18</p>  <p>Drawer Side(L) - 1pc</p>
<p>19</p>  <p>Drawer Side(R) - 1pc</p>	<p>20</p>  <p>Drawer Bottom - 1pc</p>
<p>21</p>  <p>Drawer Mid - 1pc</p>	<p>22</p>  <p>Drawer divide - 4pcs</p>
<p>23</p>  <p>Sink - 1pc</p>	

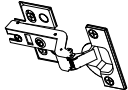
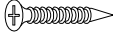
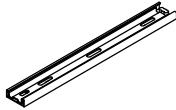
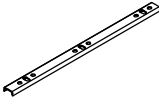
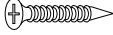
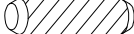
Hardware List -

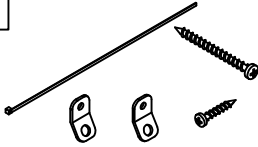
<p>A</p>  <p>ø13x1/4"x28mm</p>	<p>B</p>  <p>ø1/4"x16x1mm</p>	<p>C</p>  <p>ø6x35mm</p>
<p>Hex-Head bolts (8pcs)</p>	<p>Washer (8pcs)</p>	<p>Three in one bolts (35pcs)</p>
<p>D</p>  <p>ø14.5x12mm</p>	<p>E</p>  <p>ø8xø4x32mm</p>	<p>F</p> 
<p>Three in one lock (35pcs)</p>	<p>Round head screw (8pcs)</p>	<p>Handle (2pcs)</p>
<p>G</p> 	<p>H</p>  <p>ø5/32"x22mm</p>	<p>I</p>  <p>ø5/32"x28mm</p>
<p>Handle (2pcs)</p>	<p>Handle screw (2pcs)</p>	<p>Handle screw (4pcs)</p>
<p>J</p> 	<p>K</p>  <p>ø7xø3.5x15mm</p>	<p>L</p>  <p>ø300x35mm</p>
<p>Damping hinge (4pcs)</p>	<p>Flat head screw (24pcs)</p>	<p>Slide rails (2pcs)</p>
<p>M</p>  <p>ø298x18mm</p>	<p>N</p>  <p>ø6xø3x12mm</p>	<p>O</p>  <p>ø8x30mm</p>
<p>Slide rails (2pcs)</p>	<p>Flat head screw (12pcs)</p>	<p>Wood dowel (30pcs)</p>
<p>P</p>  <p>4mm</p>	<p>Q</p> 	
<p>Allen key (1pc)</p>	<p>Anti fall hardware (1set)</p>	

STEP: 1

C

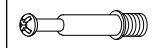

8PCS

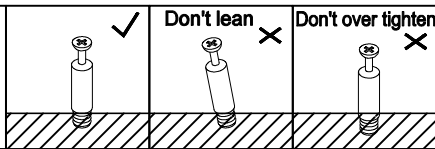
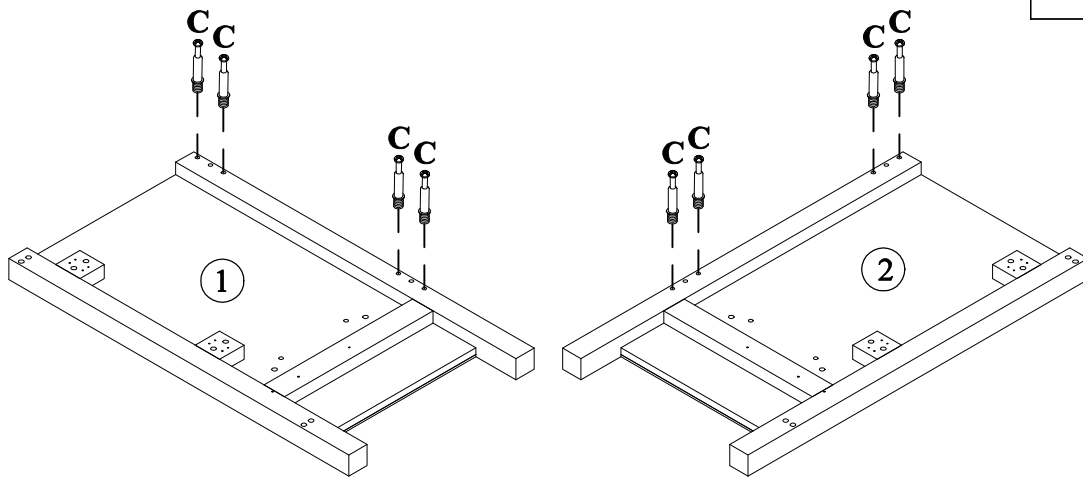

STEP: 2

L



2PCS

N



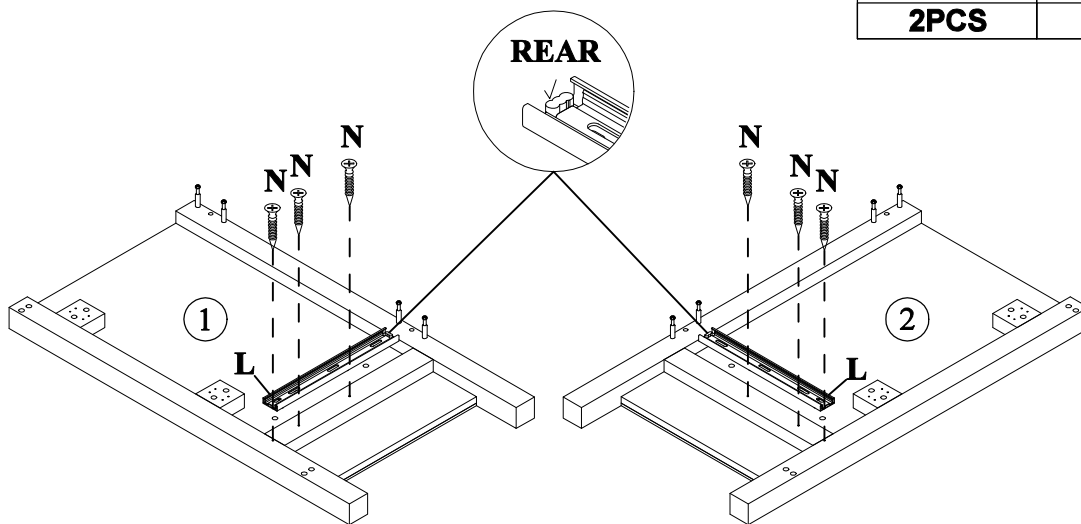

6PCS

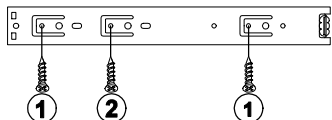

POSITION OF SCSEW



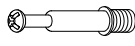

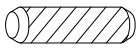

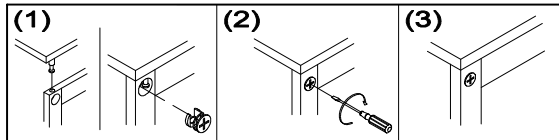
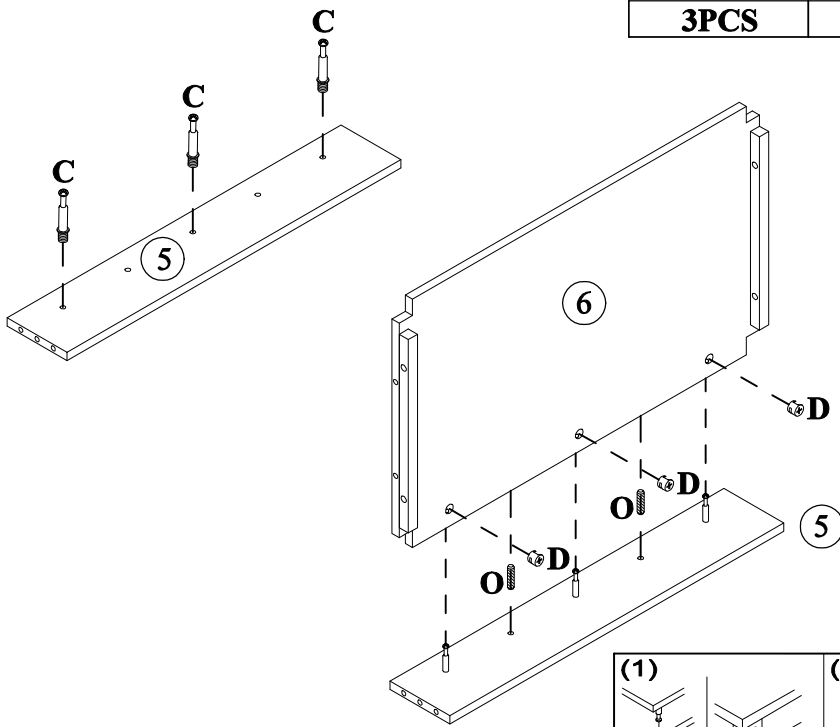
STEP: 3

C		D		O	
	3PCS		3PCS		2PCS

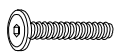

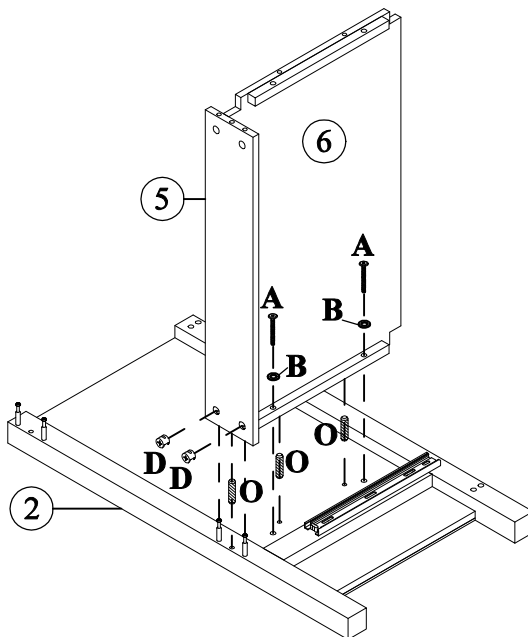

STEP: 4

A		B		D		O	
	2PCS		2PCS		2PCS		3PCS



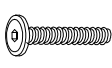

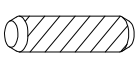
STEP: 5

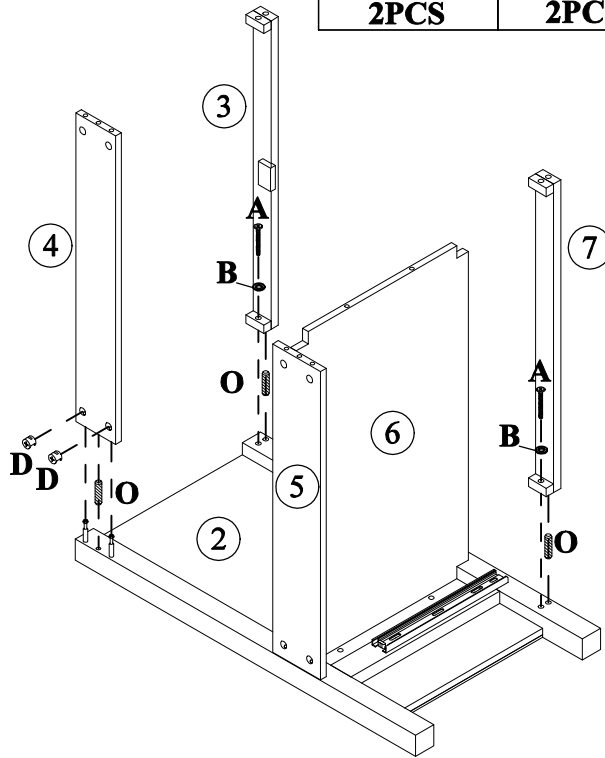
A	B	D	O
			
2PCS	2PCS	2PCS	3PCS



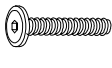

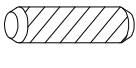

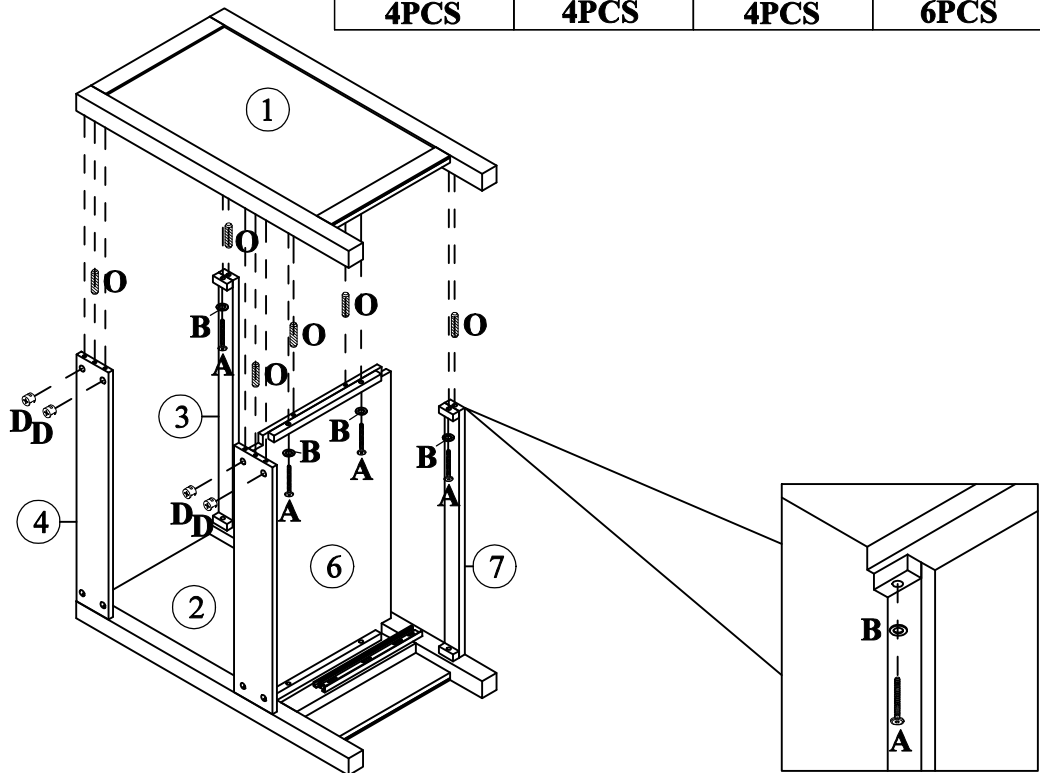
STEP: 6

A	B	D	O
			
4PCS	4PCS	4PCS	6PCS

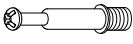



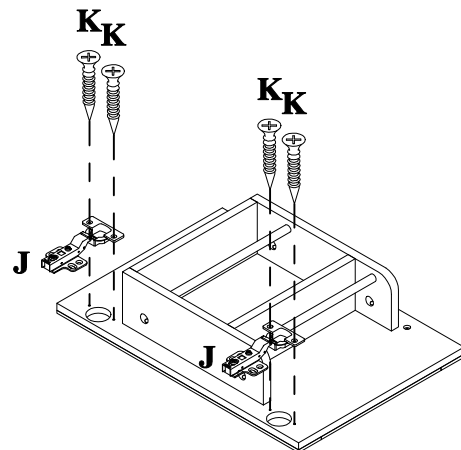
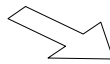
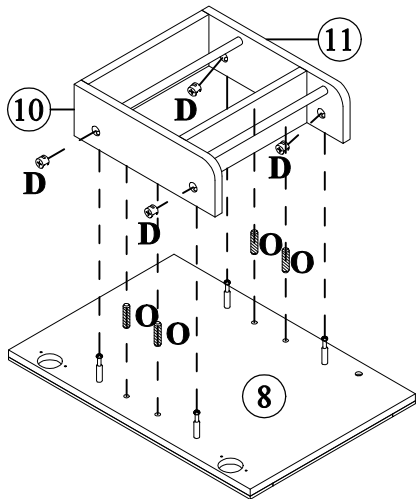
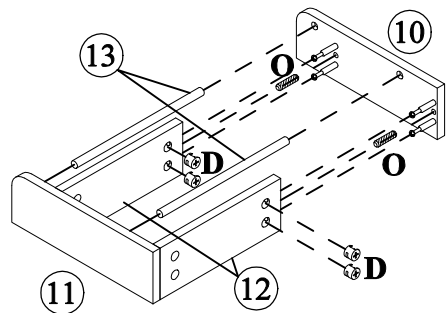
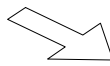
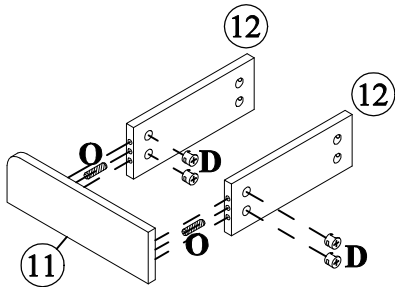
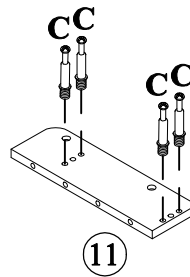
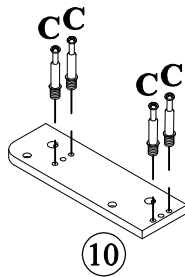
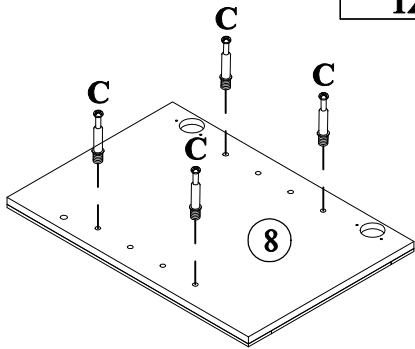

STEP: 7

C 	D 	O 	J 	K 
12PCS	12PCS	8PCS	2PCS	4PCS

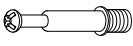

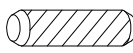

STEP: 8

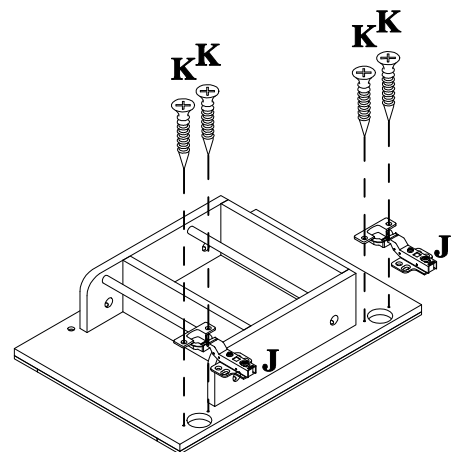
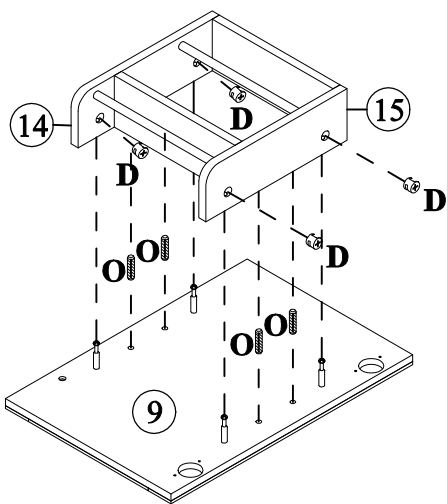
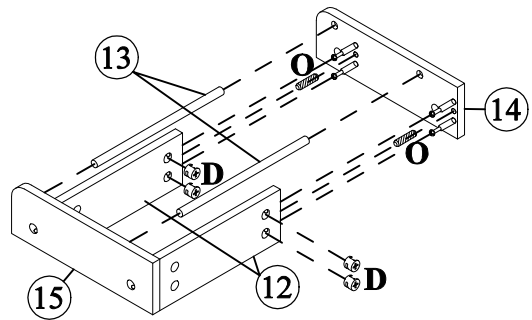
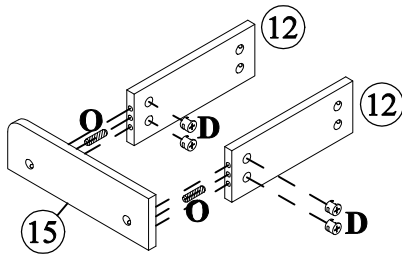
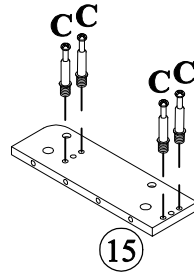
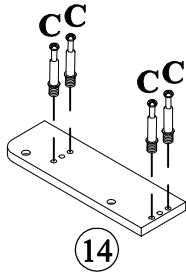
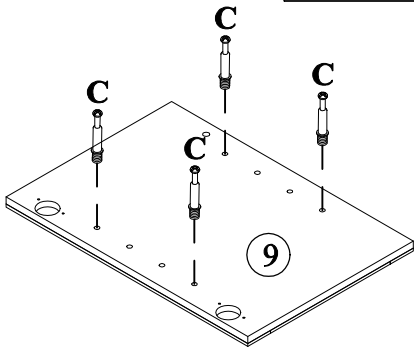
C	D	O	J	K
				
12PCS	12PCS	8PCS	2PCS	4PCS



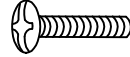

STEP: 9

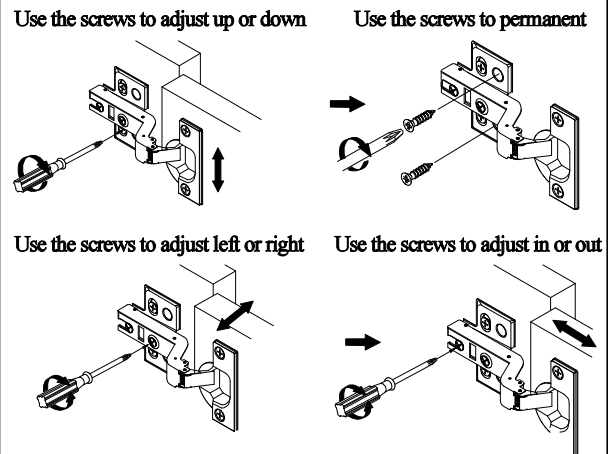
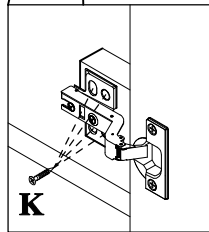
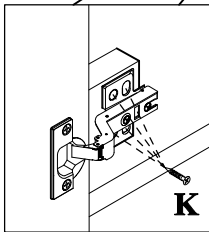
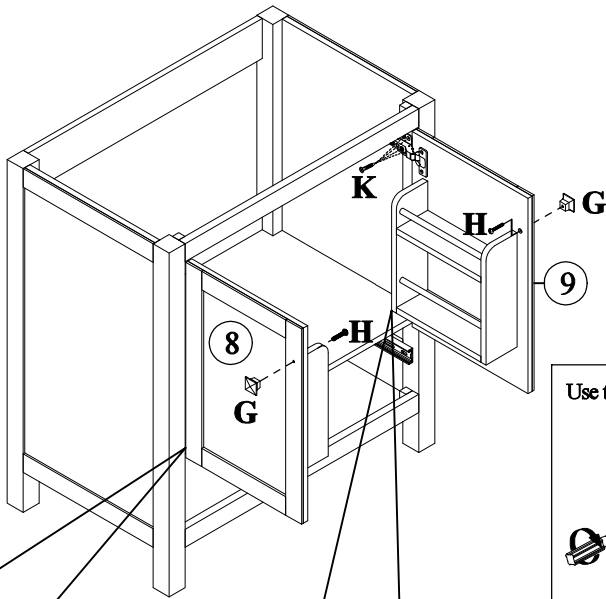
G		H		K	
2PCS		2PC		16PCS	

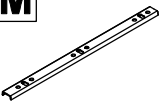

STEP: 10

M		N	
2PCS		6PCS	

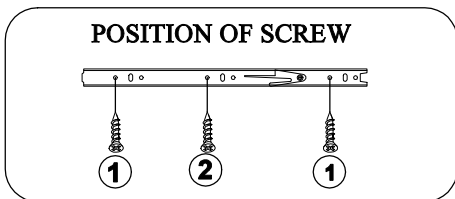
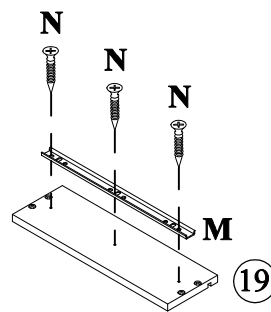
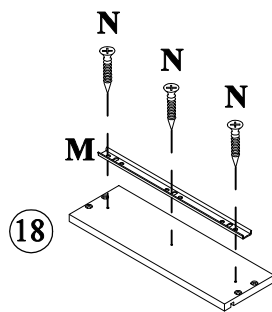

STEP: 11

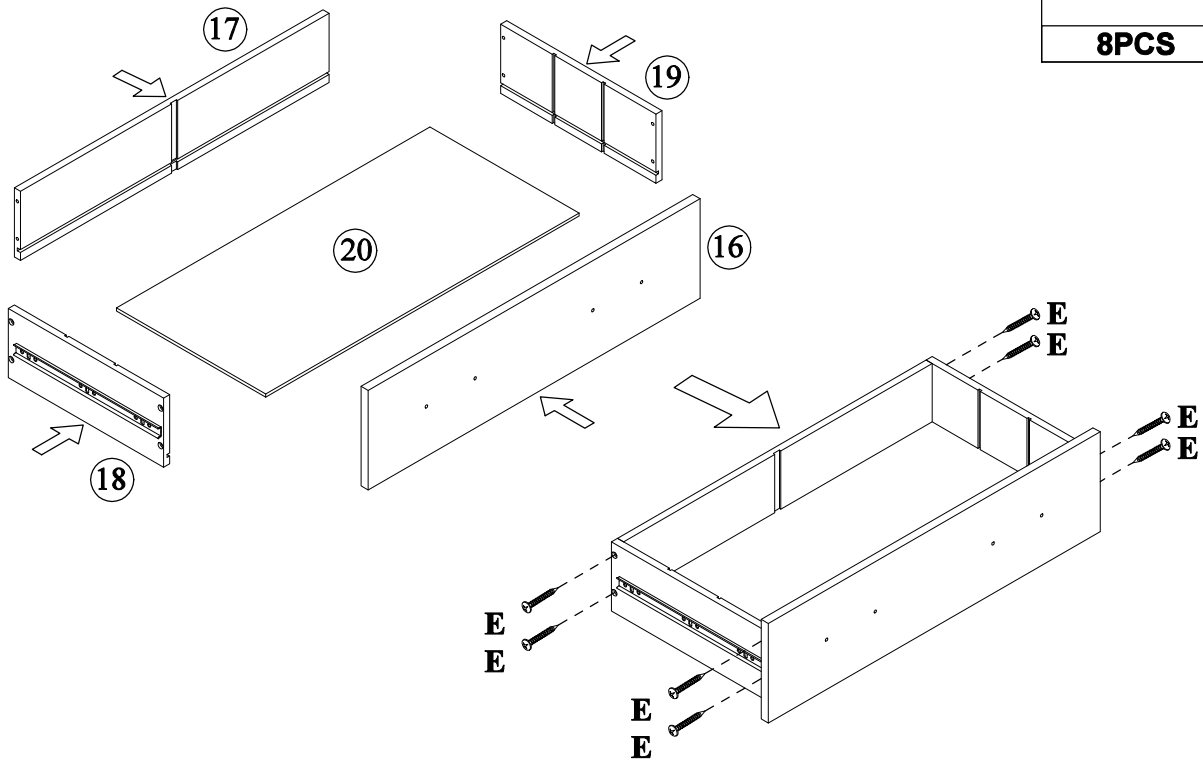

E



8PCS

STEP: 12

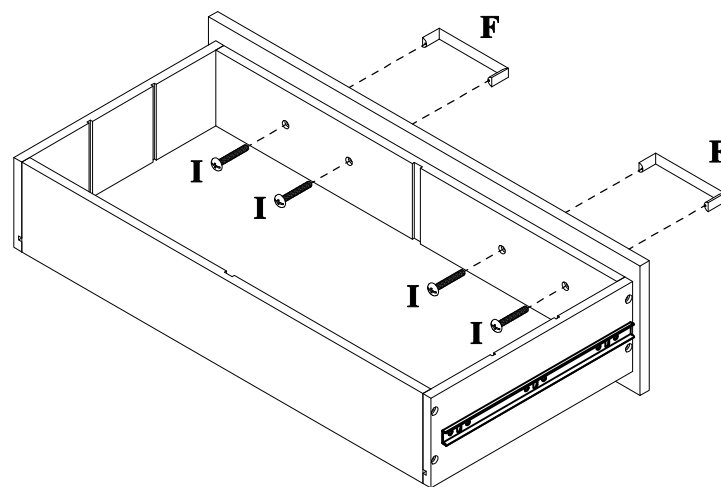

F

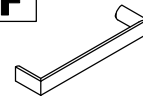

2PCS

I

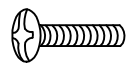

4PCS

STEP: 13

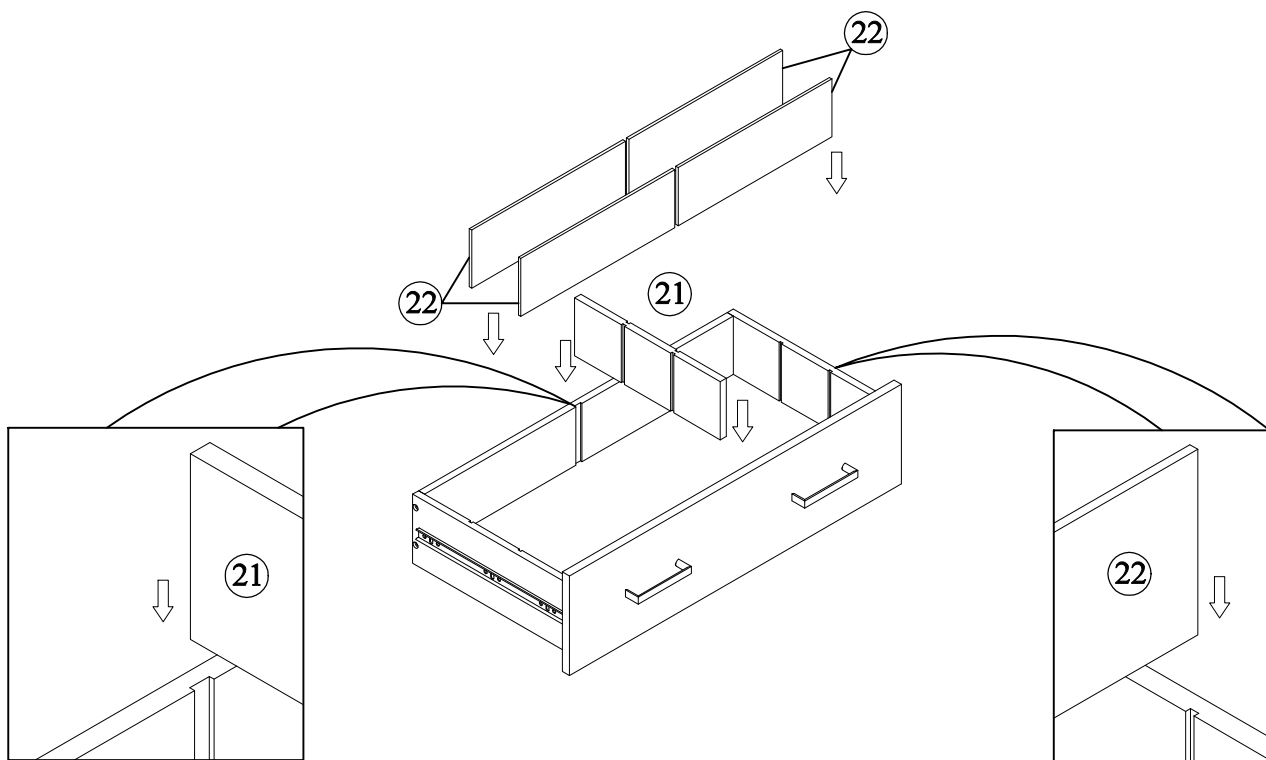

STEP: 14

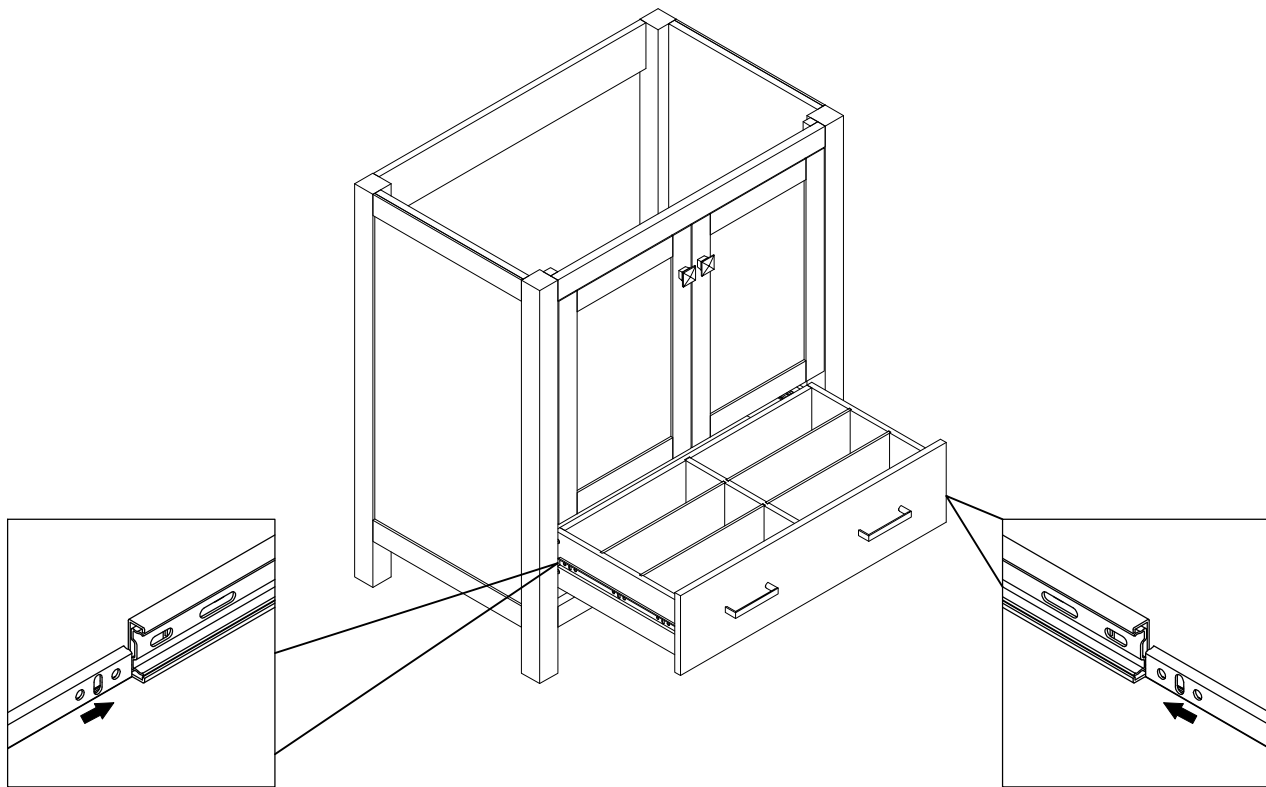

STEP: 15

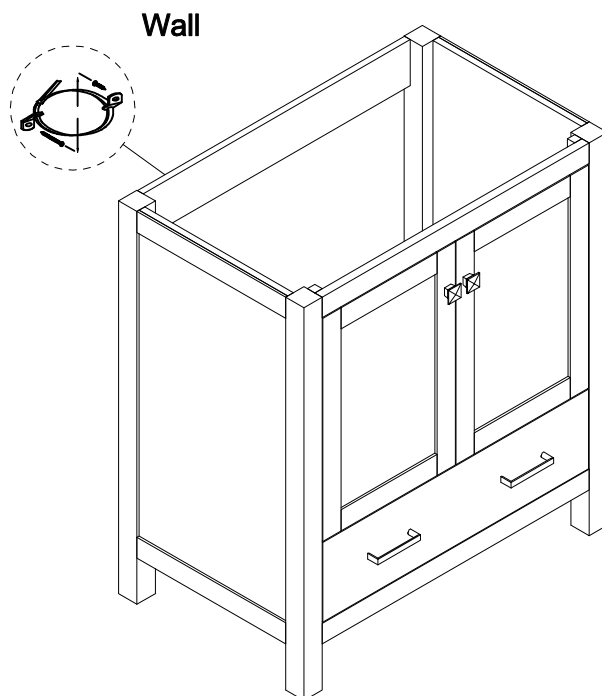
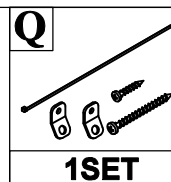

STEP: 16

Install the sink on the cabinet with glue.
Let stand for 24 hours

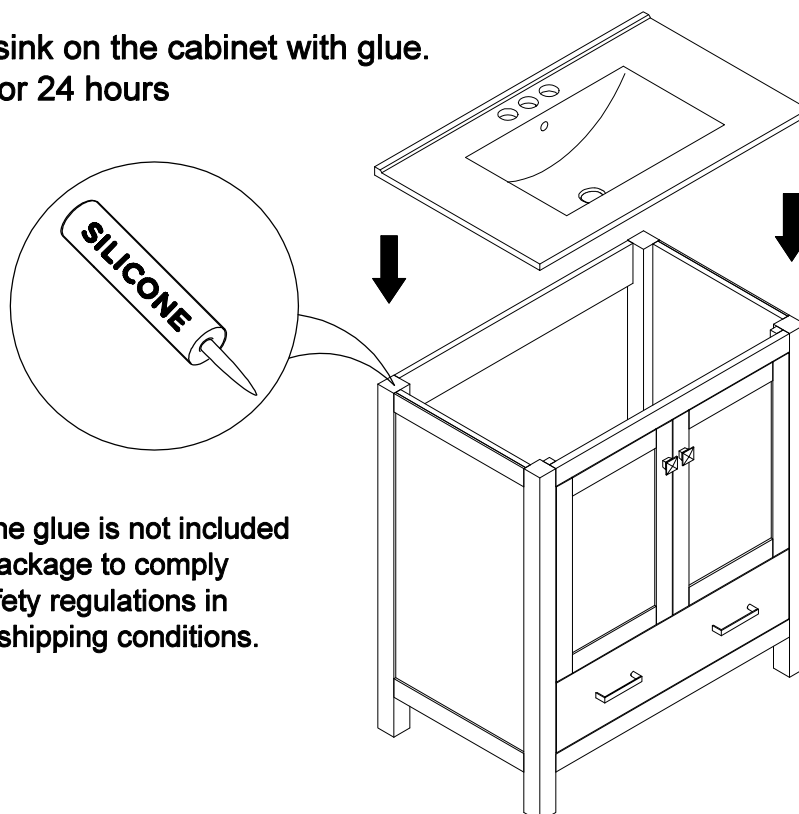

*Silicone glue is not included
in the package to comply
with safety regulations in
certain shipping conditions.

STEP: 17

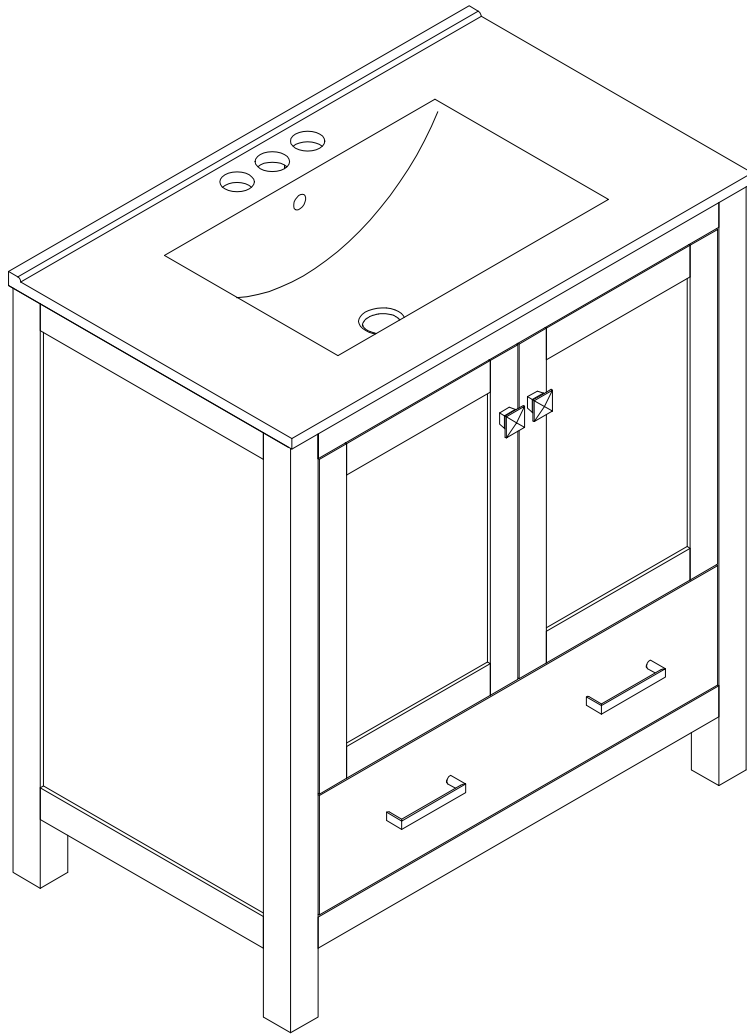

HINGE ADJUSTMENTS



1 Sideways / Tilt adjustment

Turn the screw
clockwise to move the door further away from
the side of the cabinet
anticlockwise to move the door closer to the
side of the cabinet

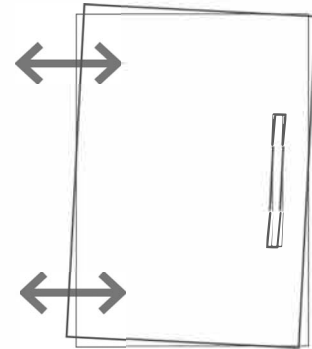

2 4 Height adjustment

While supporting the weight of the door, turn the
screws
clockwise to move the door up
anticlockwise to move the door down



3 Forward and back adjustment

If the gap between the back of the door and the
cabinet is too small, and the door may not close
fully. Turn the screw
clockwise to decrease the gap between the
door and the cabinet
anticlockwise to increase the gap between the
door and the cabinet

