

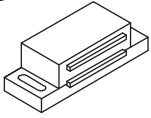







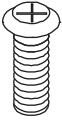

UESR'S MANUAL

Lockers

LJJ-LK-003

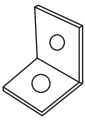
Hardware List

| | | | |
|---|---|---|---|
| A  | B  | C  | D  |
| Magnet (3pcs) | Magnet screw (6pcs) | Knob (3pcs) | Knob screw (3pcs) |
| E  | F  | G  | H  |
| Spring pins (6pcs) | Plastic anchor (1pc) | Screw (20pcs) | Cable tie (1pc) |
| I  | J  | K  | L  |
| Eyelet screw (1pc) | Short screw (1pc) | Bracket (1pc) | Cap (20pcs) |

Panel List

- 1**

Left side panel (1pc)

2

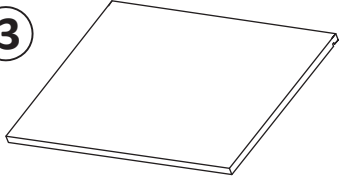
Right side panel (1pc)
- 3**

Top panel (1pc)

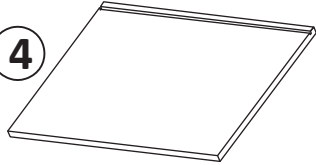
4

Bottom panel (1pc)

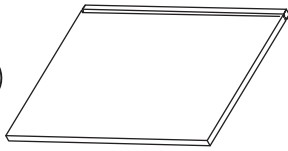
5

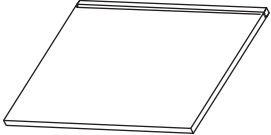
Second-shelf panel (1pc)
- 6**

Third&Fourth-shelf panel (2pcs)

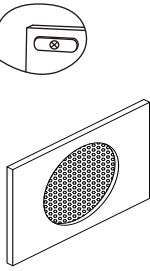
7

Door panel (3pcs)

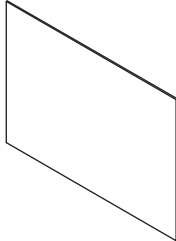
8

Back panel (4pcs)

Exploded Views

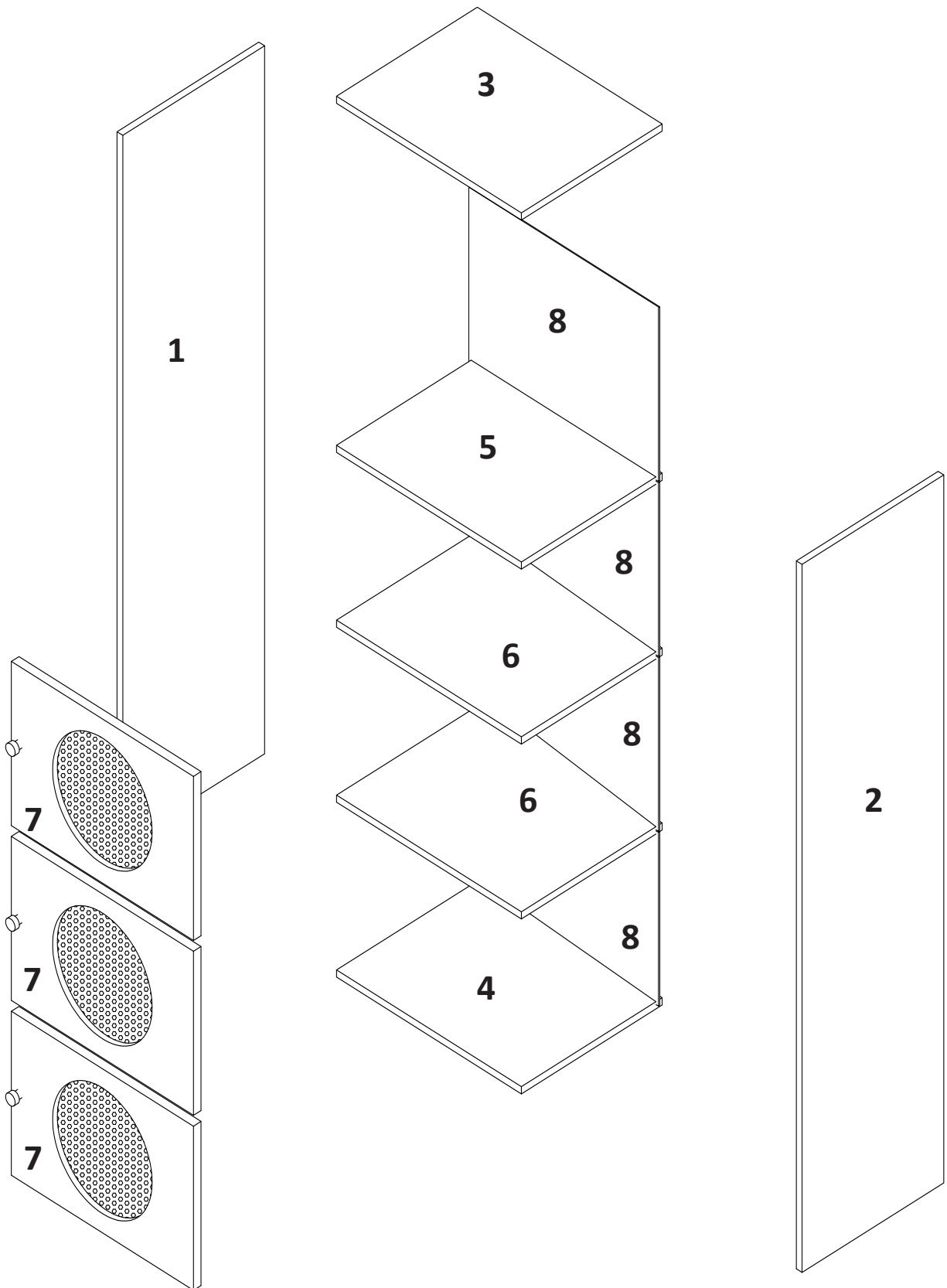

Step 1

1. Attach magnets (A) to the second - shelf panel (5) and third & fourth-shelf panels (6) with magnet screws (B).
2. Attach knobs (C) to doors (7) using knob screws (D).
3. Insert spring pins (E) into doors (7) as shown.

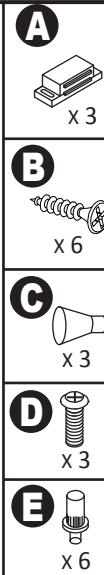
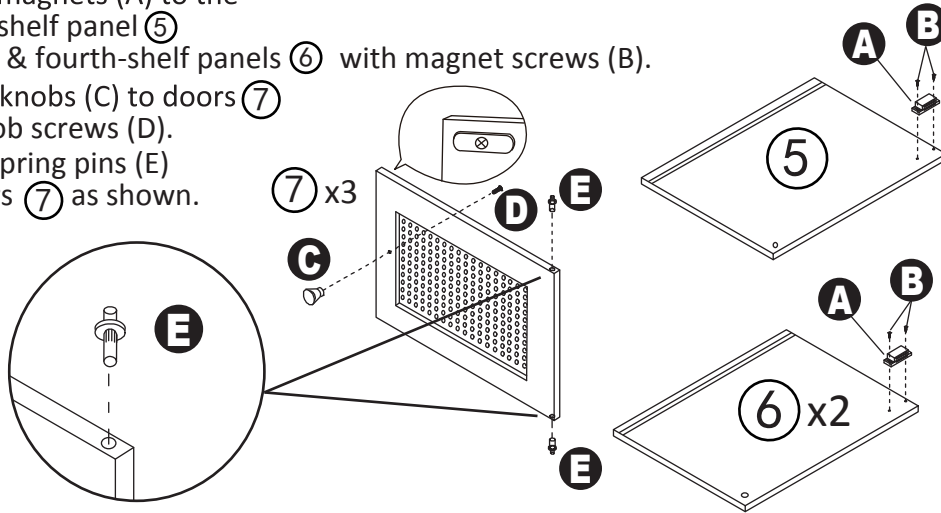

Step 2

1. Connect top panel (3), second -shelf panel (5), third & fourth-shelf panels (6) and bottom panel (4) to left side panel (1) with screws (G).
2. Slide back panels (8) into the grooves of the unit.

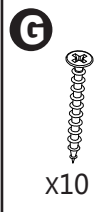
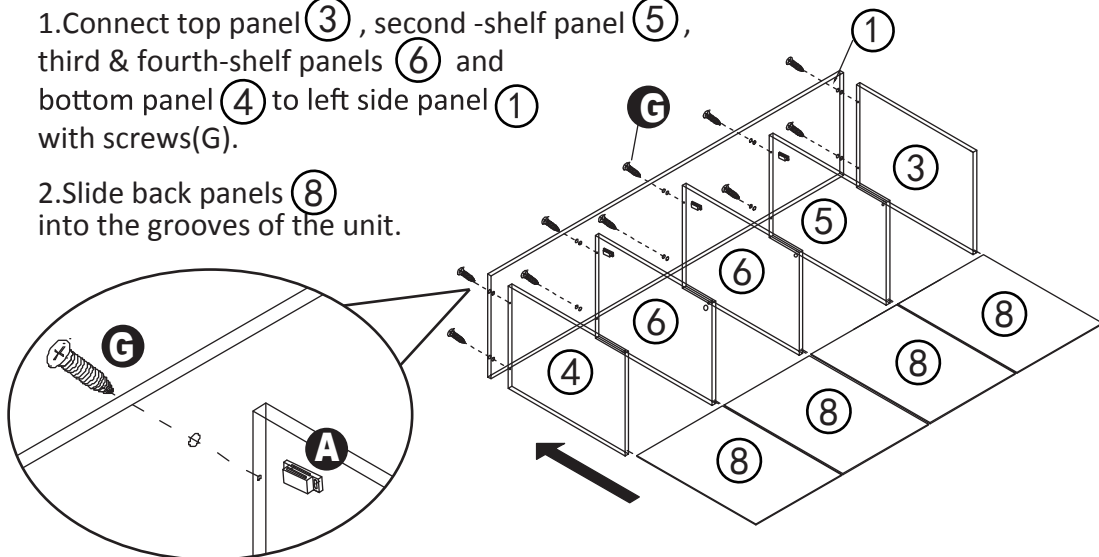

Step 3

1. Connect right side panel (2) to unit with screws (G).

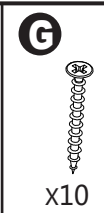
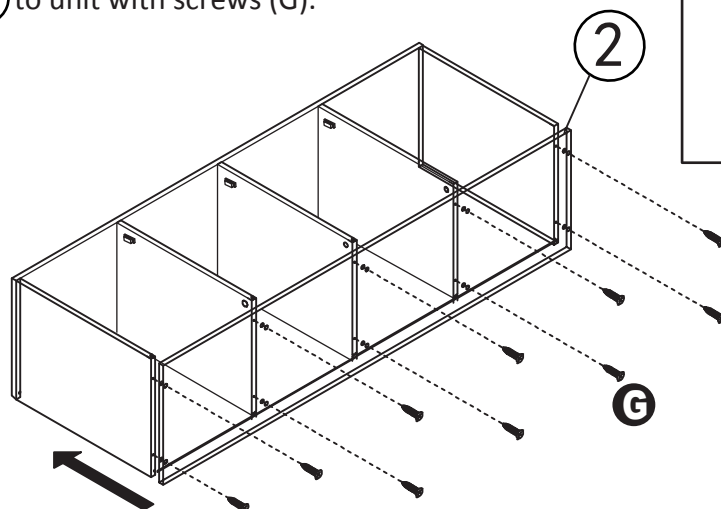

Step 4

1. Insert doors (7) into unit by placing one end of spring pins (E) into holes, gently compress other spring pins (E) so that it will slide into remaining holes.

TO ATTACH DOORS

Push door spring pins (E) down. Align with pre-drilled hole in unit. Release.

Push

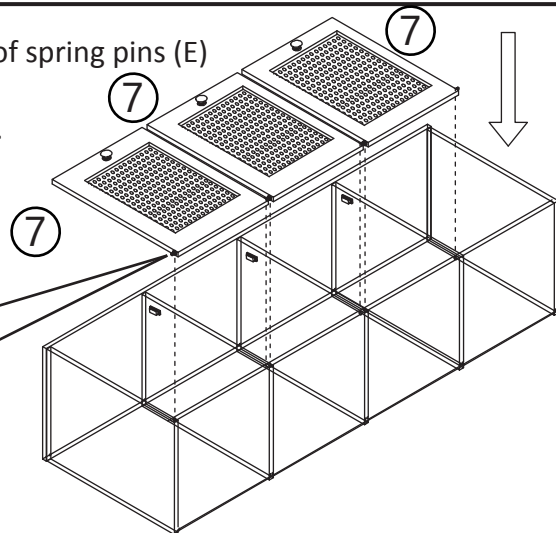
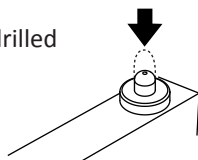

Step 5

1. Cover the screw holes with caps (L).

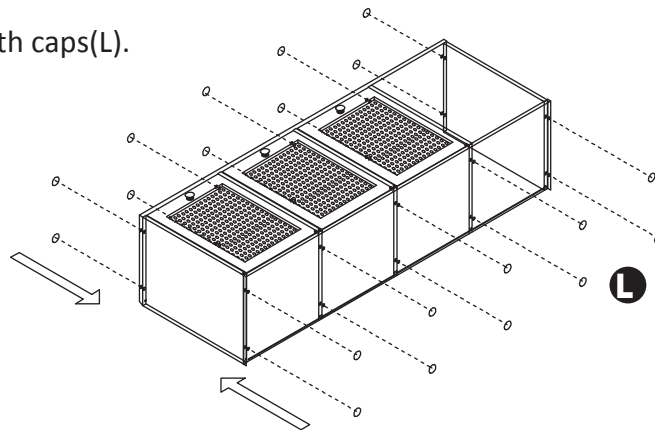

L



x 20

Step 6

1. Connect bracket (K) to unit as shown using short screw (J).
2. Drill hole slightly smaller than plastic anchor (F) into drywall and gently tap plastic anchor into hole.
3. Insert eyelet screw (I) into plastic anchor (F) and fasten unit to wall using cable tie (A).

