

# Office Chair

User Manual



## Product specification

Product Name: Office Chair  
Size: 74\*33\*58 cm/ 29.1\*13\*22.8 inches

Net Weight: 18.6 kg/ 41 lbs  
Gross Weight: 20.6 kg/ 45.4 lbs

## ATTENTION







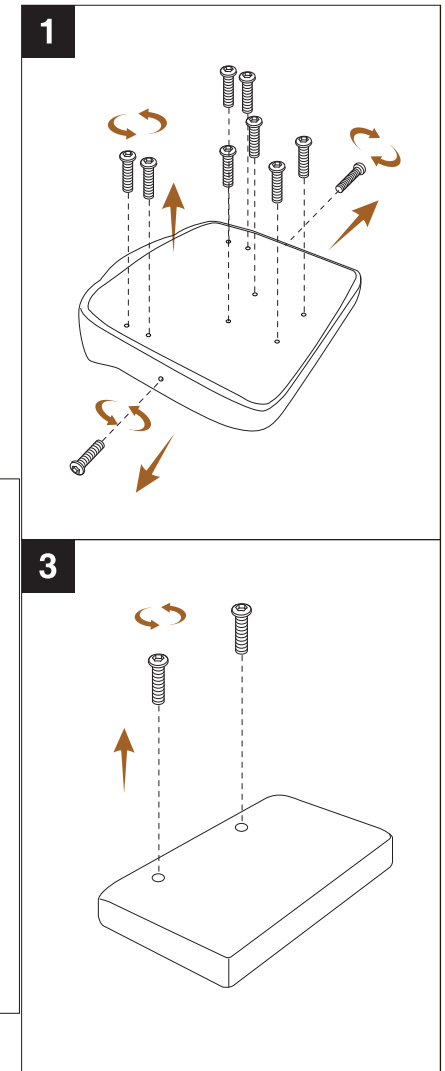
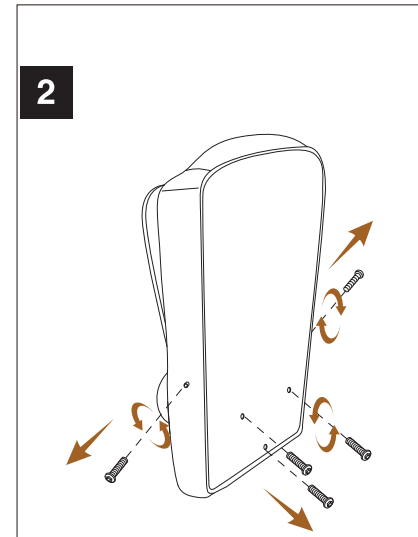





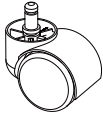
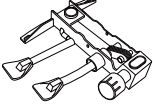
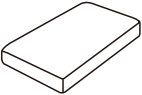

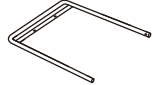
Some screws are pre-installed on the chair and are NOT included in the hardware pack.

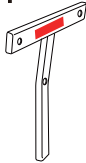
Please check the screw number according to the instruction manual and look for it on the chair!

**Please remove the pre-installed screws before installation**

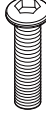

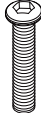
## PACKING LIST

|  |   |   |  |  |
|--|---|---|--|--|
| A*1<br>           | B*1<br>            | C*1<br>            | H*5<br>           | D*1<br>           |
| R*1<br>            | Y*2<br>            | T*1<br>            | F*1<br>           | L*1<br>           |
| G-R*1<br>          | G-L*1<br>          | S*1<br>            | P*4<br><br>6*20mm | J*4<br><br>8*40mm |
| Q*1<br><br>5*10mm | K*3<br><br>6*40mm | N*6<br><br>6*30mm | M*4<br>           |  |
|  |   |   |  |  |

## INSTALLATION

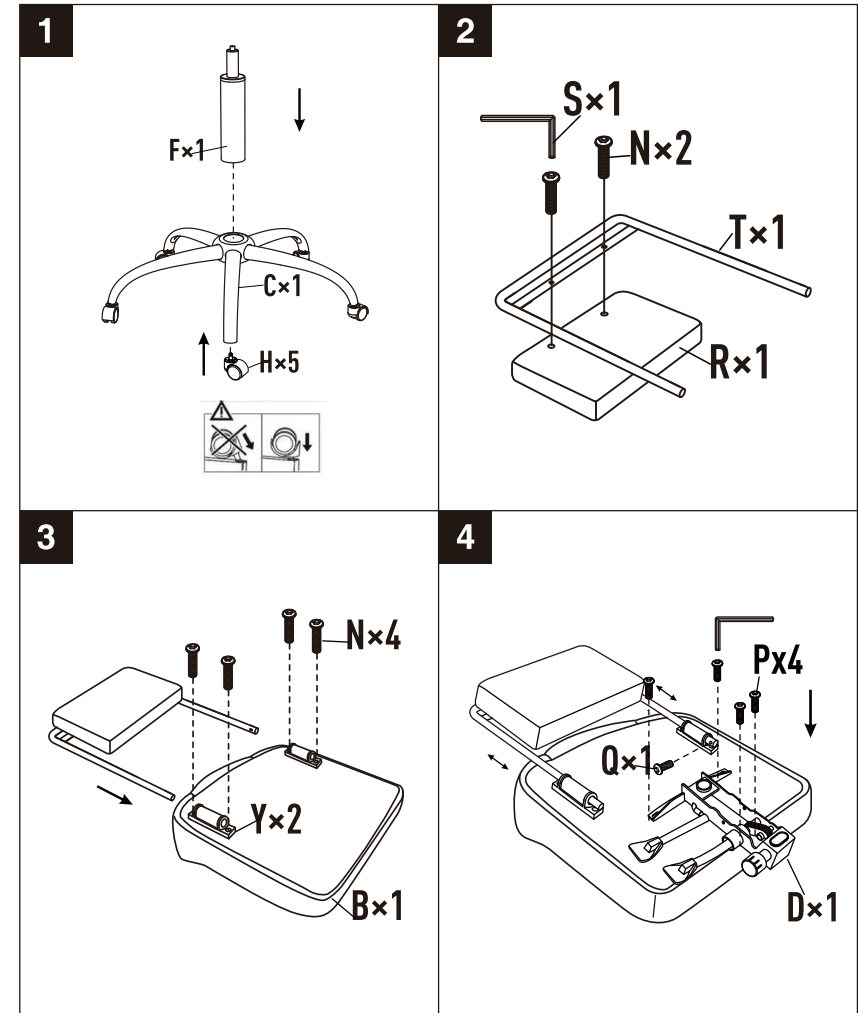

**Note:** All screws have been preassembled to the accessories. Please remove them from the accessories before assembling.

## INSTALLATION

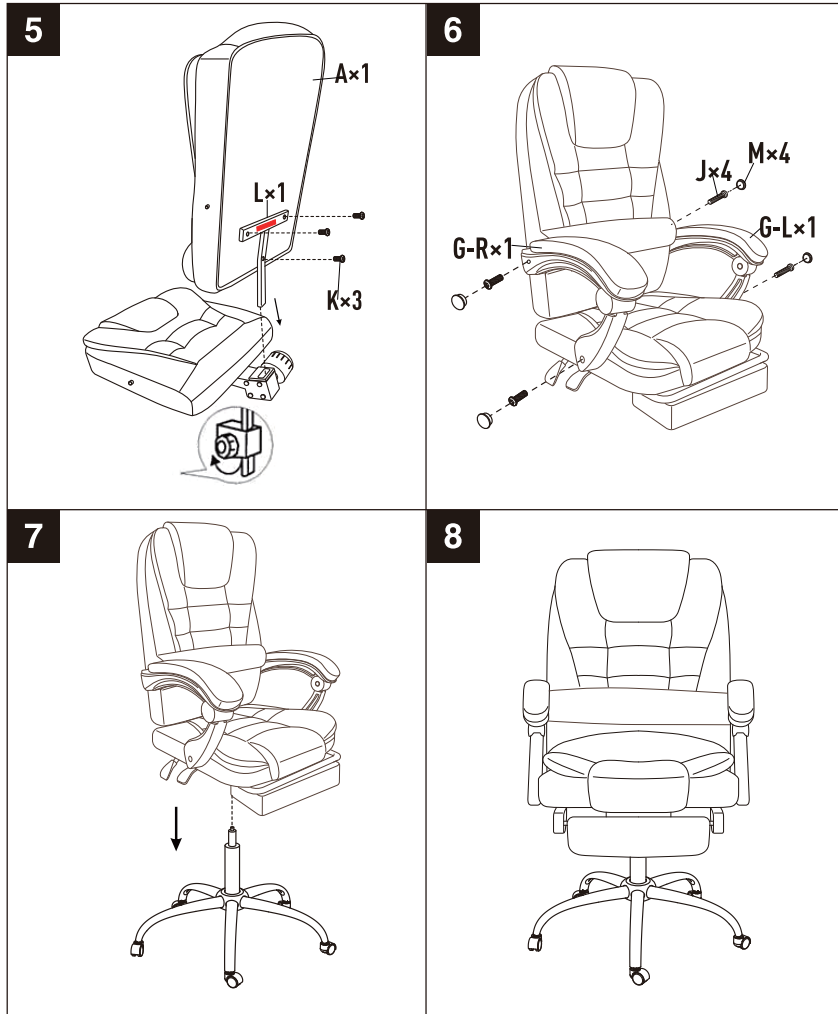

**Note:** All screws have been preassembled to the accessories. Please remove them from the accessories before assembling.

## TROUBLESHOOTING

| Fault conditions                    | Possible causes   | Exclusion method  |
|-------------------------------------|---|---|
| The product is shaking and unstable | <ol style="list-style-type: none"> <li>1. Wrong screw installation</li> <li>2. The screw is broken</li> <li>3. Check that the screws are not tightened in place</li> </ol>  | <ol style="list-style-type: none"> <li>1. According to the instruction manual, install the correct screw in the correct position</li> <li>2. To replace, use the included spare screws</li> <li>3. Tighten the loose screws</li> </ol>                            |
| The light strip is off              | <ol style="list-style-type: none"> <li>1. Not plugged in</li> <li>2. The lighting pattern is not saved correctly</li> </ol>   | <ol style="list-style-type: none"> <li>1. Confirm that the product is powered on normally</li> <li>2. Please read the instructions of the remote control carefully (page 6), and follow the operation</li> </ol>  |
| Audio doesn't work                  | <ol style="list-style-type: none"> <li>1. Bluetooth connection failed</li> <li>2. Bluetooth connection error</li> </ol>   | <ol style="list-style-type: none"> <li>1. Turn on your phone's bluetooth to connect</li> <li>2. Turn off the phone's Bluetooth and reconnect (Bluetooth name: HuaBox)</li> </ol>  |
| Remote control not working          | <ol style="list-style-type: none"> <li>1. The remote control gasket is not pulled out and cannot work</li> <li>2. The battery is in poor contact or the battery is installed backwards</li> <li>3. The battery is dead</li> </ol> | <ol style="list-style-type: none"> <li>1. Check whether the remote control gasket is pulled out</li> <li>2. Check whether the battery is installed incorrectly and adjust</li> <li>3. Replace the new battery to make the remote control work normally</li> </ol> |