

## WARRANTY

We strive to offer high-quality products, and we also try our best to satisfy each and every customer that orders from us with product or service as needed. We provide 30 days warranty starting from the time you receive the item. Each customer must provide a record of their order such as the order number, or item receipt for any items that are out of the warranty period you may also still receive replacement parts by purchasing them with our company if they are available.

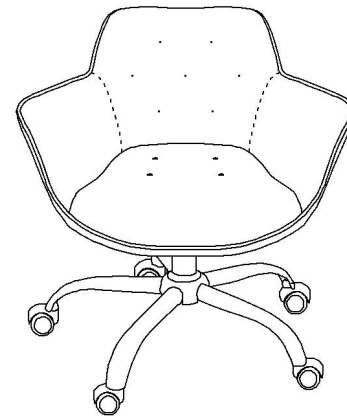

---

### NOTE:

This brochure contains IMPORTANT safety info. Please read and keep for future reference.

---

# MAINTAINANCE AND WARNING

- Keep furniture away from heat.
- Do not clean furniture with harsh cleansers or polish. Do not use detergents, Solvents, abrasives, spray packs or leather cleaner. Use non-color mild soap with warm water clean spills(Mix 1:10 soap to water)
- Do not place furniture under direct sunlight, material will possibly fade over time.
- Do not use on site dry Cleaning machine.
- Children should not climb or jump on the furniture.
- Do not write on furniture without a padded barrier to protect the surface.
- To obtain the longest lifespan of your outdoor products, avoid exposure to rain or snow, and direct sunshine for long time. Whenever possible cover the product and/or place under patio or awnings.
- Not for commercial use, For residential use only.



Weight Limitation

**220LBS**

# PARTS LIST

A\*1(Seat)

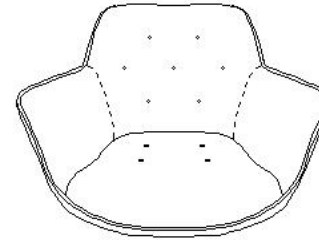

D\*1(Spider base)

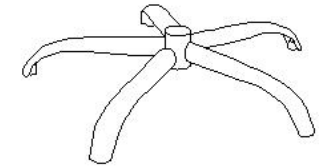

B\*1(Bottom machanism)

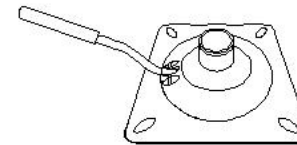

E\*5(Casters)

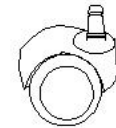

C\*1(Gas lift)



F\*1(Plastic cover)



Estimated Duration Of Assembly

**5-10 MINUTES**

# HARDWARE LIST

G\*4  
M6\*18mm

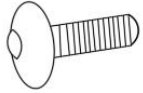

H\*4  
M6\*16mm

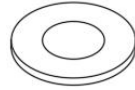

I\*4  
M6



J\*1  
M5



## SPARE

G\*1  
M6\*18mm

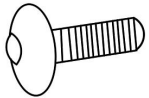

H\*1  
M6\*16mm

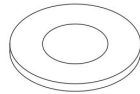

I\*1  
M6



Be sure to check all packing material carefully for small parts, which may have come loose inside the carton during shipment.

# ASSEMBLY INSTRUCTIONS

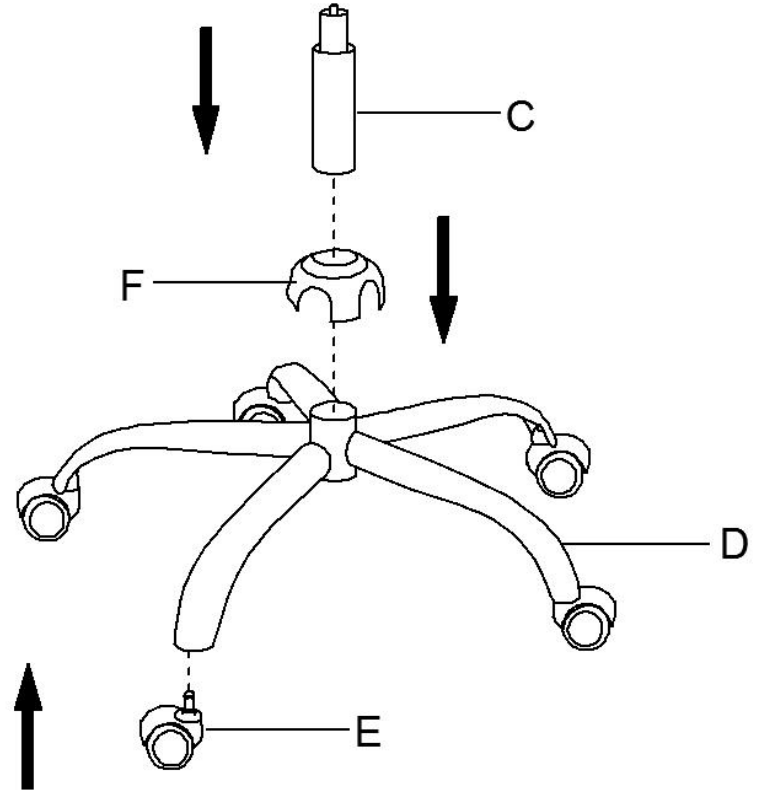

**STEP 1:** Insert caster E to bottom of the spider base D, attach the metal cover F on top of the base then insert the gas lift to the center hole of the base.

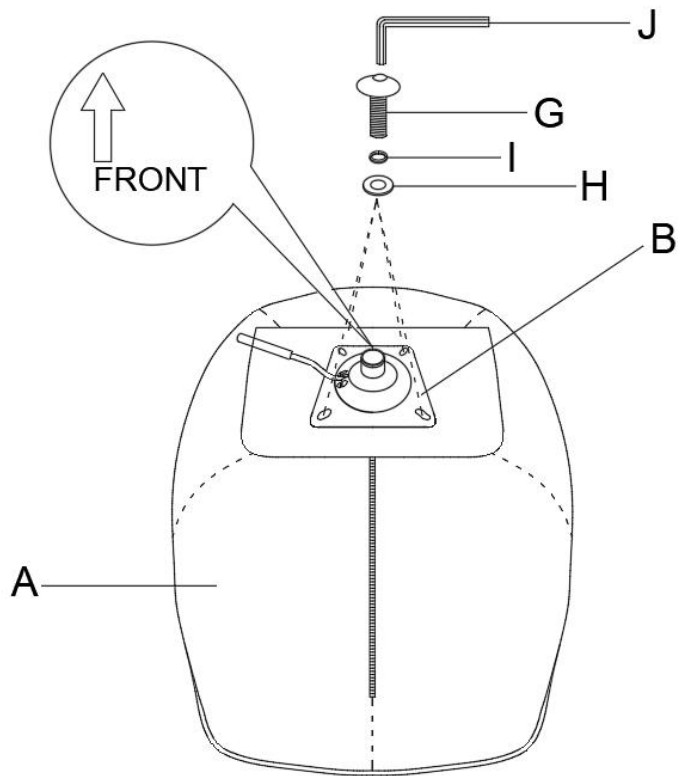

**Attention: Do not fully tighten the bolts until all the bolts align with the holes; please be sure you align the hole first !**

**STEP 2:**Use bolt G ,Spring washer I , flat washer H and allen key J to attach mechanism B to bottom of the seat A,make sure the holes on under seat align with metal plate,then fasten bolts to secure.

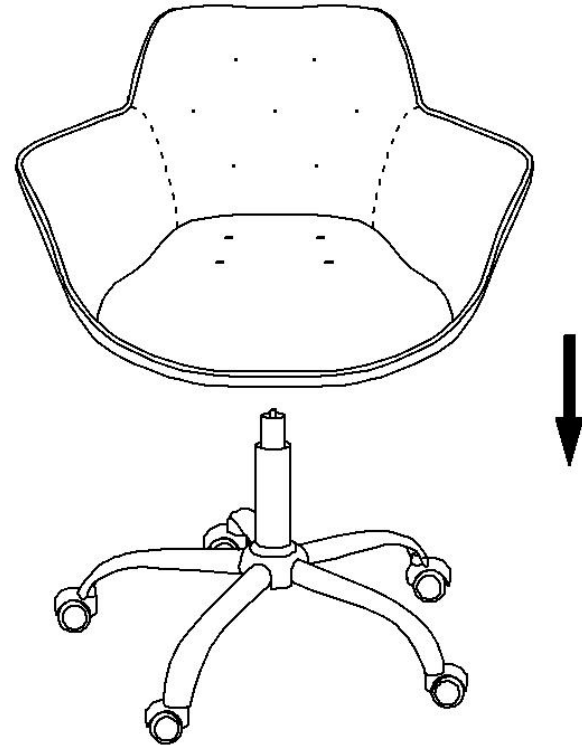

**STEP 3:**Set the chair seat A upright and align top of gas lift C and center hole of metal plate B,push down to secure.