

CONSOLE TABLE

Assembly Instructions - Please keep for future reference

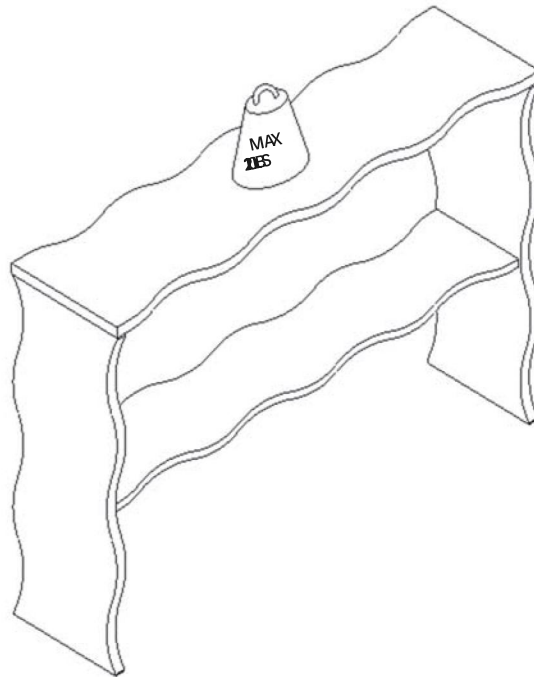

Dimensions

Width-47.24inch

Depth-11.81inch

Height-32.28inch

Important-Please read these instructions fully before starting assembly



Safety and Care Advice

Important – Please read these instructions fully before starting assembly

- Check you have all the components and tools listed on the following pages.
- Remove all fittings from the plastic bags and separate them into their groups.
- Keep children and animals away from the work area, small parts could choke if swallowed.
- Make sure you have enough space to layout the parts before starting.

- During assembly do not stand or put weight on the product, this could cause damage.
- Assemble the item as close to its final position (in the same room) as possible.
- Assemble on a soft level surface to avoid damaging the unit or your floor.
- Parts of the assembly will be easier with 2 people.



power drill is set on a low torque setting.

- To reduce the likelihood of damaging your product please ensure that your

Care and maintenance

- Only clean using a damp cloth and mild detergent, do not use bleach or abrasive cleaners.
- From time to time check that there are no loose screws on this unit.
- This product should not be discarded with household waste. Take to your local authority waste disposal centre.

Handy Hints

- Assemble all parts and bolts loosely during assembly, only once the product is complete should you fully tighten the bolts
- Regularly check and ensure That all bolts and fittings are tightened properly.

WARNING

In order to help prevent overturning – please follow these instructions











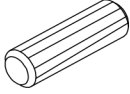
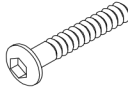
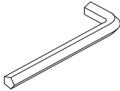
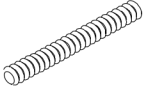

To help prevent product toppling over please follow the below steps:-

Use the anti tip stap or wall fixing method provided (if applicable)
Do not allow children to climb or hang on the furniture
Pls do not place heavy items on the top and shelf.
Do not place heavy items on top of the furniture, unless the furniture has been designed for this purpose

Components - Fittings

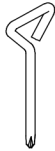
Please check you have all the panels listed below

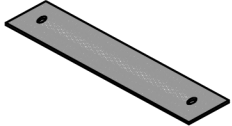
Note: The quantities below are the correct amount to complete the assembly. In some cases more fittings may be supplied than are required.

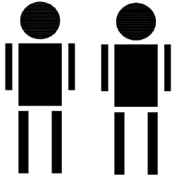
<p>A</p>  <p>35MM x8+2</p>	<p>B</p>  <p>∅14.5 x8+2</p>	<p>C</p>  <p>∅8*30 x12+1</p>	<p>D</p>  <p>M6*60 x8</p>	<p>E</p>  <p>M4 x1</p>
<p>F</p>  <p>M8*70 x4</p>	<p>G</p>  <p>M8 x4</p>	<p>H</p>  <p>M8 x4</p>	<p>I</p>  <p>x1</p>	<p>J</p>  <p>∅50 x4</p>
<p>K</p>  <p>∅22 x8</p>	<p>L</p>  <p>x1</p>	<p>M</p>  <p>∅7*25 x1</p>	<p>N</p>  <p>∅4*50 x1</p>	<p>O</p>  <p>180*25 x1</p>
<p>P</p>  <p>∅3.5*15 x1</p>	 <p>Person x2</p>			

Step 1

Connect the male camlock as directed in the assembly instructions using a screwdriver.

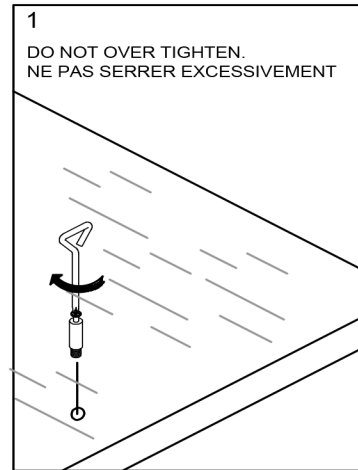

Step 2

Push the male camlock into the entry hole.

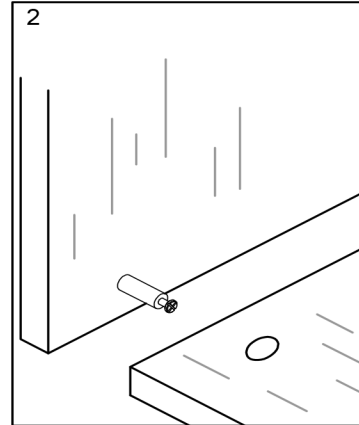

Step 3

Insert the female camlock as shown in the instruction.

Note: ensure that the arrow on the top of the camlock points towards the entry hole for the male camlock.

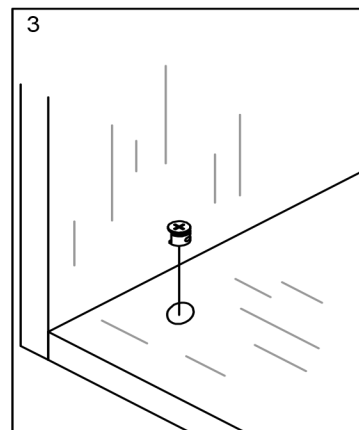

Step 4

Turn the female camlock clockwise with a screwdriver.

You should feel a click when the camlock is locked in place.

The joint is now secure.

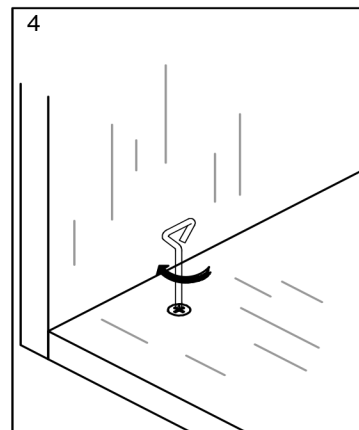

Using Camlocks 4 in 1

Step 1

Push the male camlock into the entry hole.

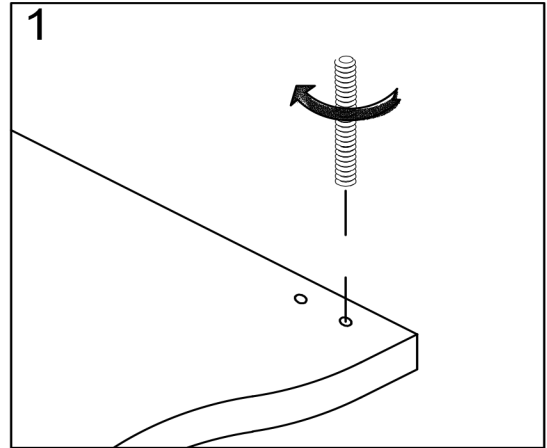

Step 2

Push the male camlock into the entry hole.

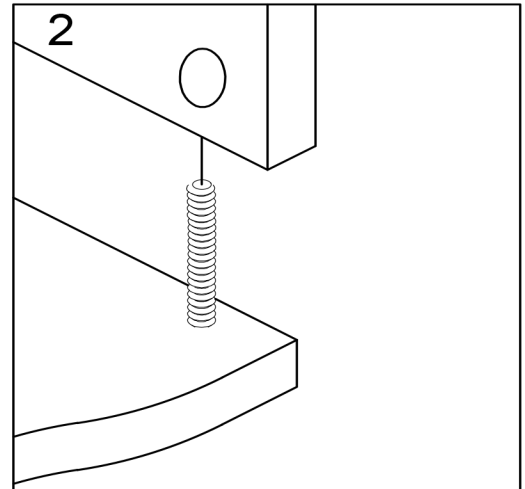

Step 3

Insert the female camlock (half-moon cam and screw nut) to ensure the female camlock hole points towards the screw pole of the male camlock.

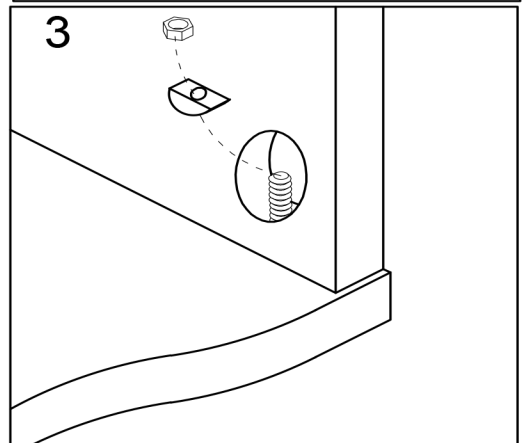

Step 4

Turn the female camlock clockwise with a wrench till the camlock is locked tightly.

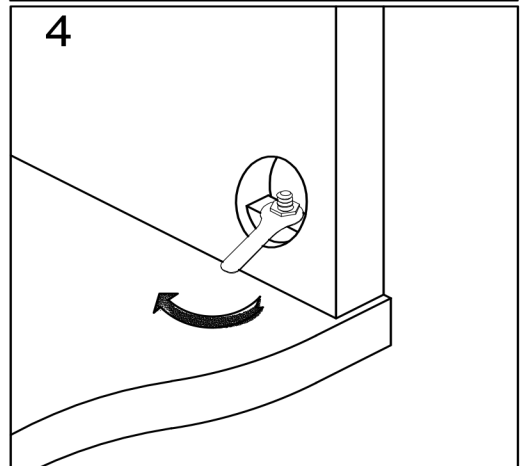

Assembly Instructions

① *1

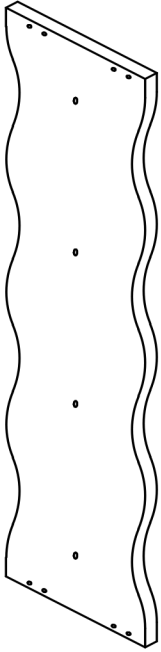

1200*300*25mm

② *2

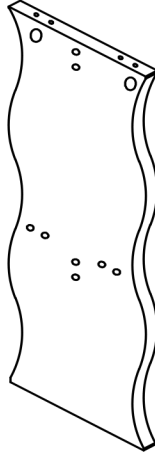

788*296*25mm

③ *1



1144*256*18mm

④ *2







1144*50*25mm

Assembly Instructions

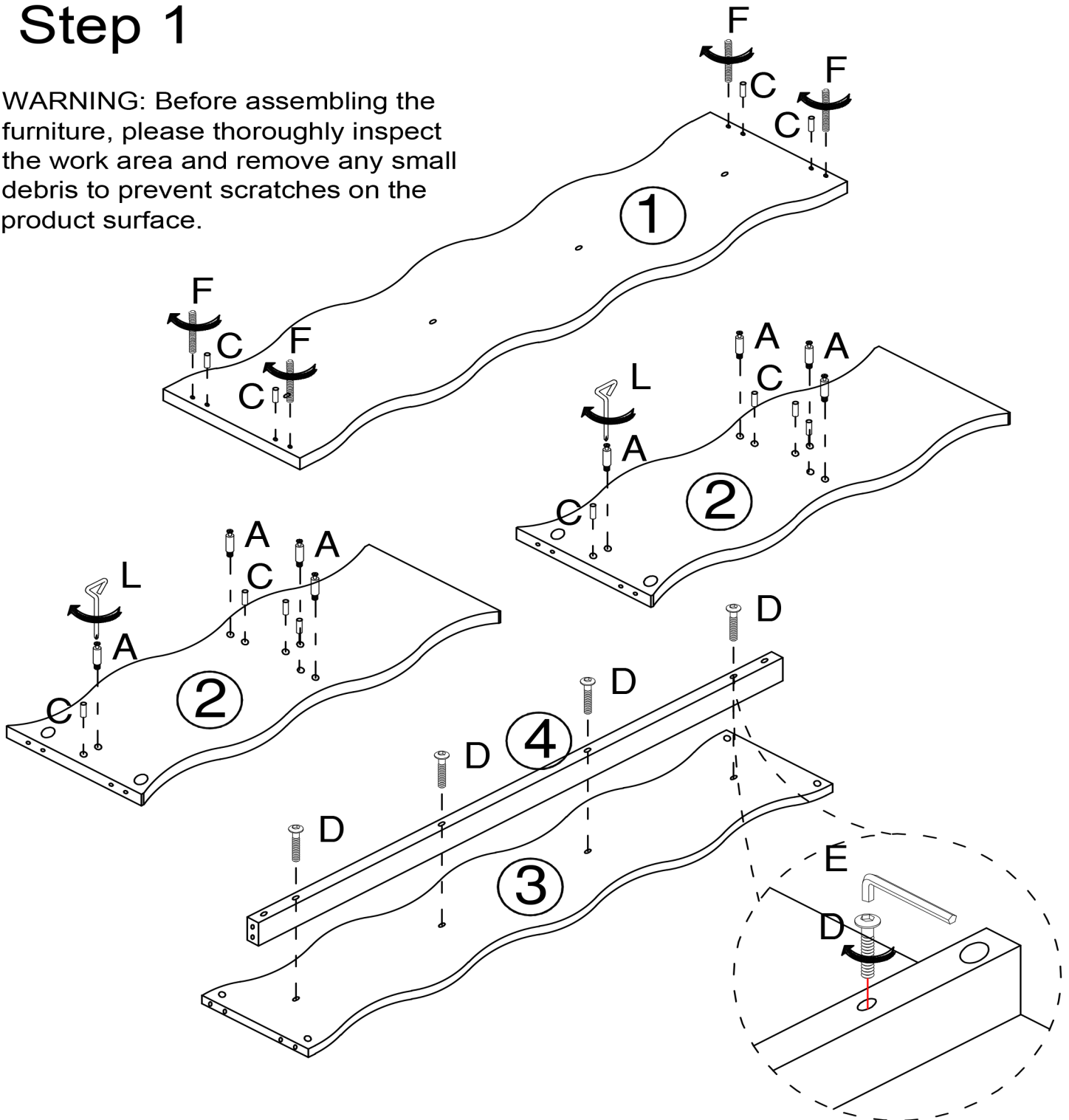
Step 1

WARNING: Before assembling the furniture, please thoroughly inspect the work area and remove any small debris to prevent scratches on the product surface.

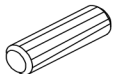
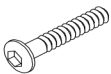
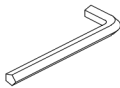
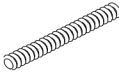



<p>A</p>  <p>35MM x8</p>	<p>C</p>  <p>∅8*30 x12</p>	<p>D</p>  <p>M6*60 x4</p>	<p>E</p>  <p>M4 x1</p>	<p>F</p>  <p>M8*70 x4</p>	<p>L</p>  <p>x1</p>	 <p>Person x2</p>
---	---	--	---	---	--	--

Assembly Instructions

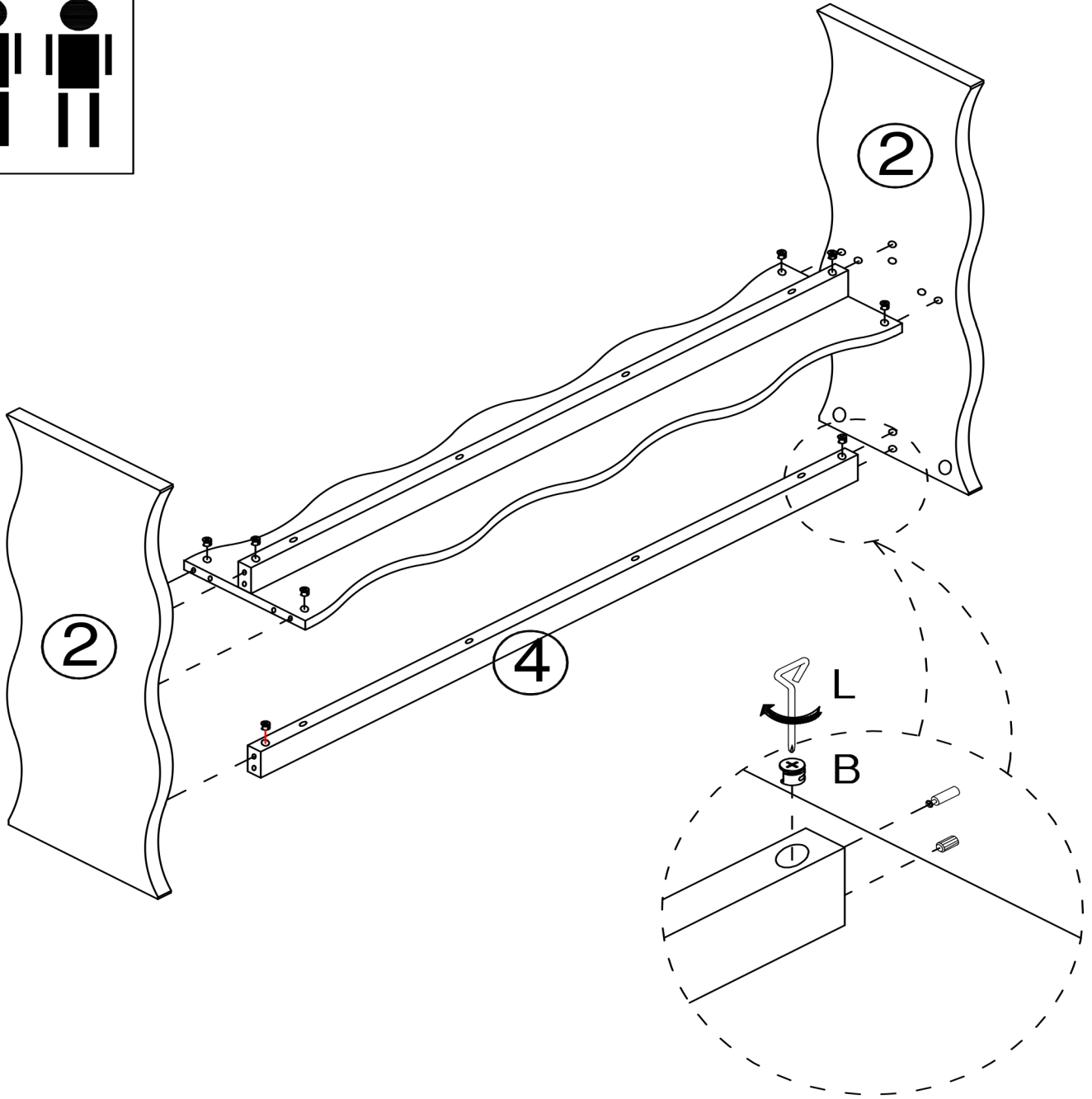
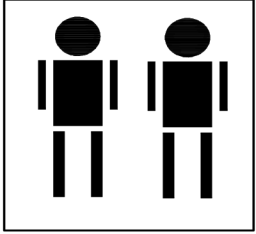
Step 2





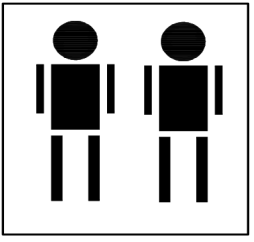
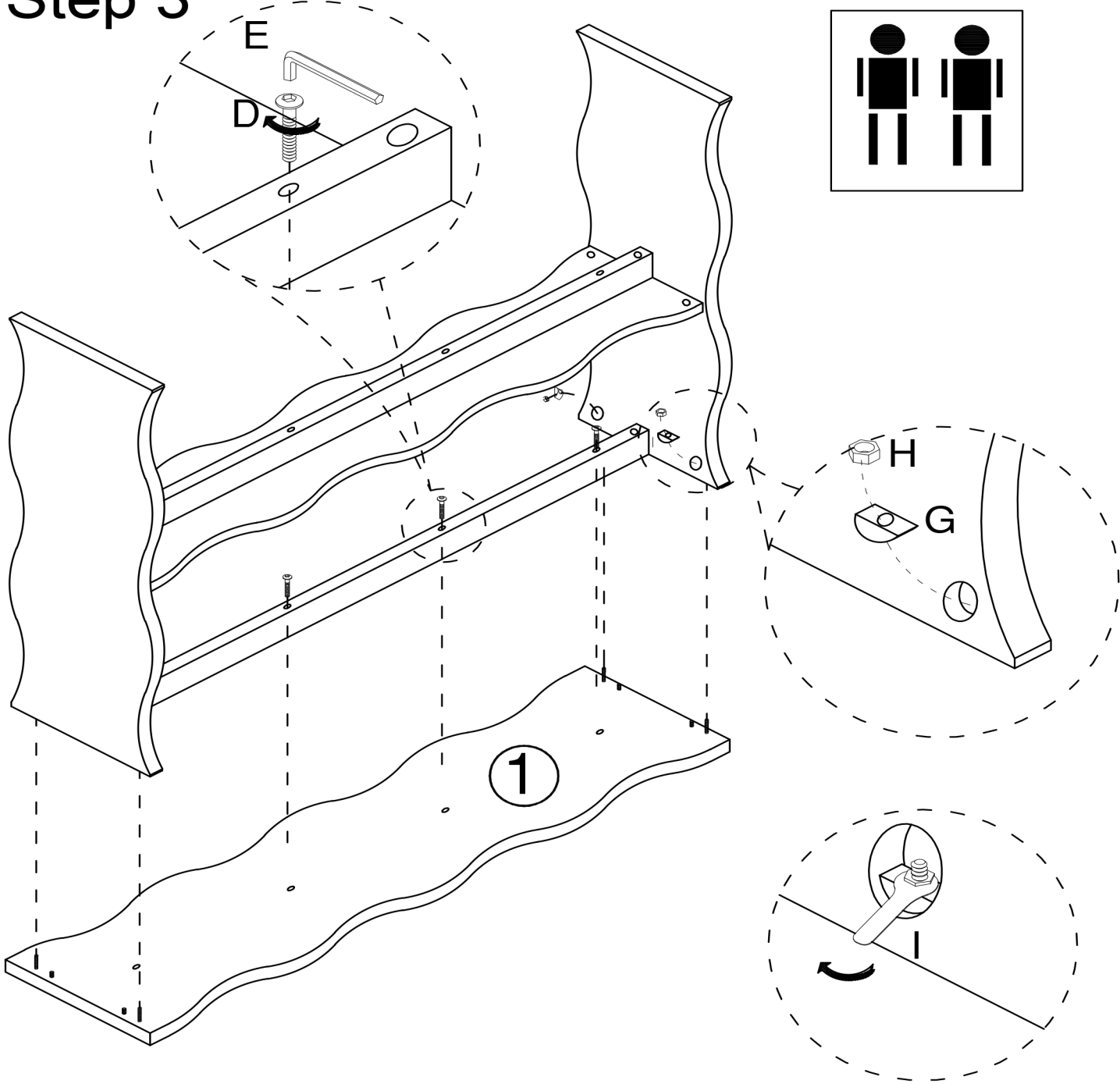

<p>B</p>  <p>ø14.5 x8</p>	<p>L</p>  <p>x1</p>	 <p>Person x2</p>
--	--	--

Assembly Instructions

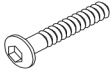
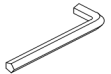

Step 3

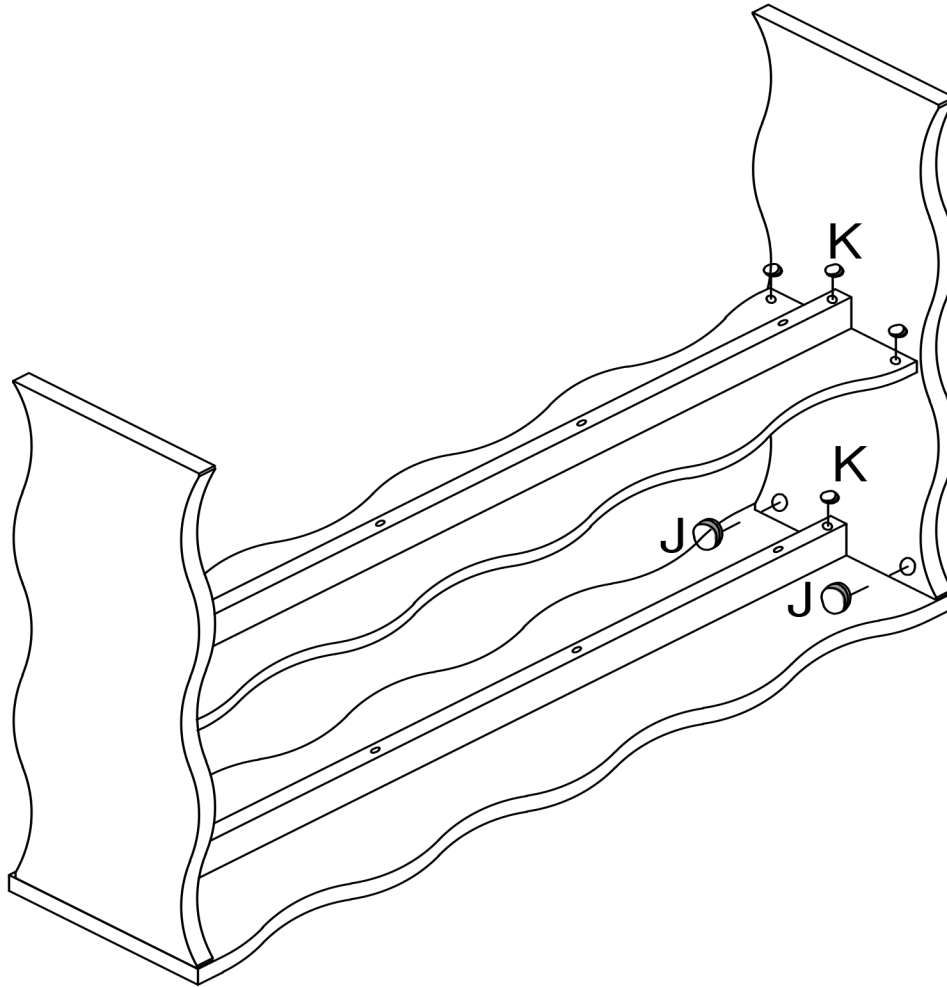

<p>D</p>  <p>M6*60 x4</p>	<p>E</p>  <p>M4 x1</p>	<p>G</p>  <p>M8 x4</p>	<p>H</p>  <p>M8 x4</p>	<p>I</p>  <p>x1</p>	 <p>Person x2</p>
--	---	---	---	--	--

Step 4

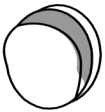

J  ø50 x4	K  ø22 x8	 Person x2
---	---	---

Assembly Instructions

Step 5

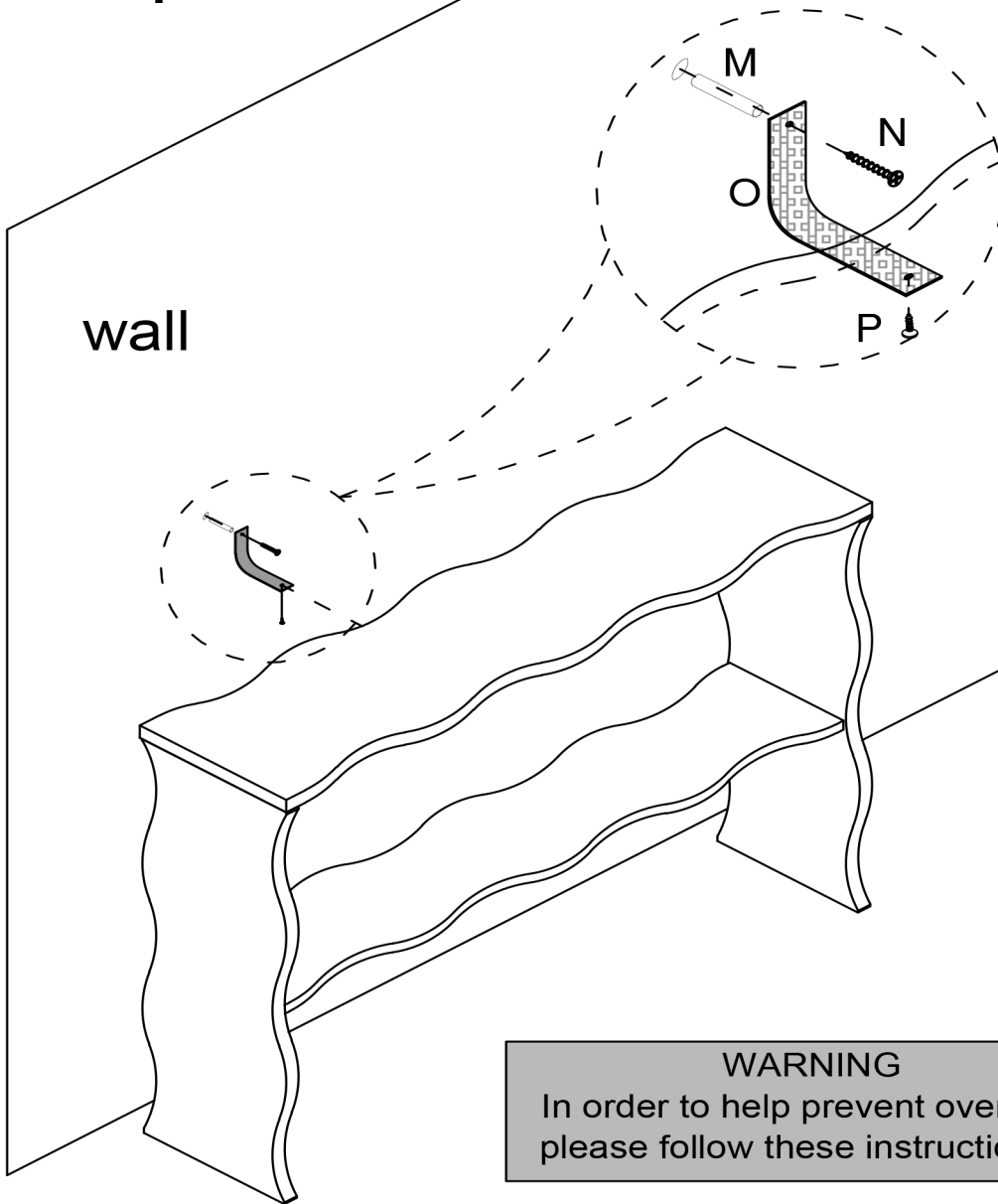

WARNING
In order to help prevent overturning –
please follow these instructions



To help prevent product toppling over please follow the below steps:-

Use the anti tip stop or wall fixing method provided (if applicable)

Do not allow children to climb or hang on the furniture

Pls do not place heavy items on the top and shelf.

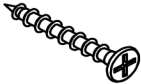
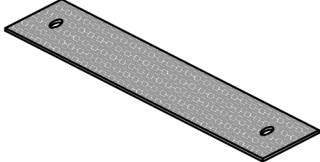
Do not place heavy items on top of the furniture, unless the furniture has been designed for this purpose

<p>M</p>  <p>Ø7*25 x1</p>	<p>N</p>  <p>Ø4*50 x1</p>	<p>O</p>  <p>180*25 x1</p>	<p>P</p>  <p>Ø3.5*15 x1</p>	 <p>Person x2</p>
--	--	---	--	--

Step 6

