



assembly instructions

Thank you for choosing a rose arch or trellis

All our trellises are made of **low-maintenance** and **weatherproof** plastic. Below are the assembly instructions for each model.

The individual parts can be assembled in a **plug-in system** and do not require any tools. You may choose to use a **6–10 mm drill**.

Assembly instructions Rose arch from page 3

Assembly instructions Trellis from page 9

Rose arch *Overview of variants*



Rose arch with planter boxes



Rose arch

Rose arch with planter boxes

content

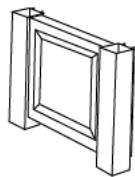

4 x side panel with post

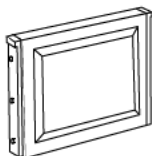

4 x side panel

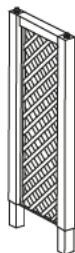

2 x trellis



4 x cap



2 x base plate

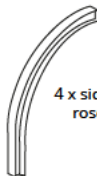

4 x side panel, rose arch



2 x middle panel, rose arch

assembly

1

2 x

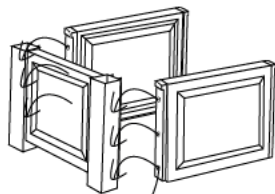

- 1.
- 2.
- 3.

1. Insert the round tabs into the openings
2. Press the part down
3. Let it click into place.
Caution! The part may break if too much force is applied!

2

2 x

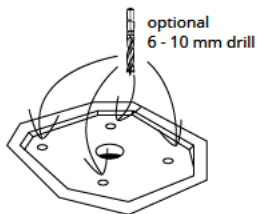

3

2 x

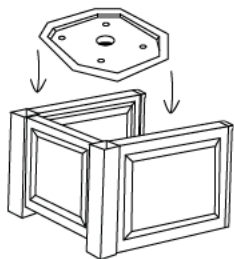

4

2 x

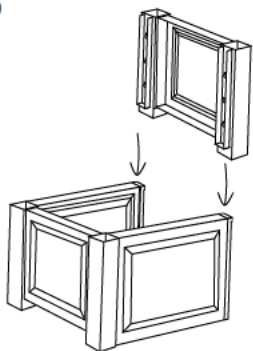

5

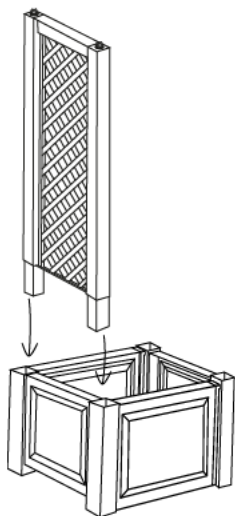
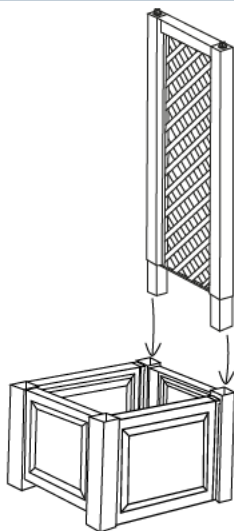

6



7



2 x

1. hold together
2. plug together

8

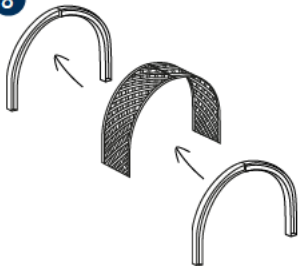

9

1. hold together
2. slide onto the cross dome, offset and from behind

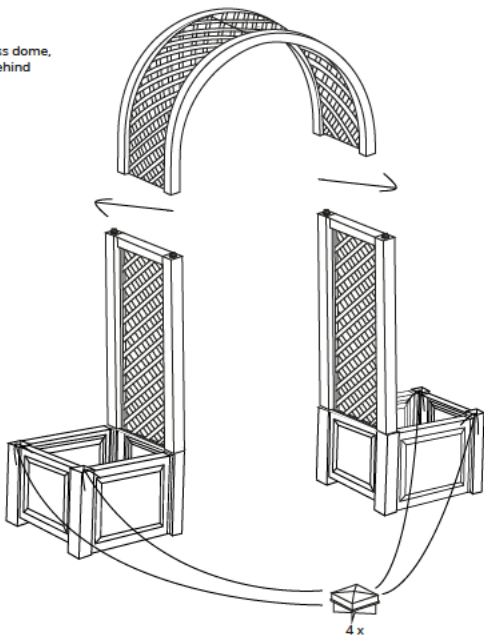

4 x

Rose arch content

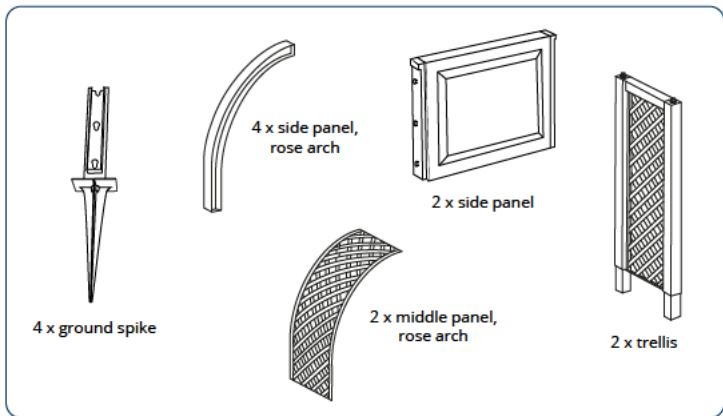

assembly

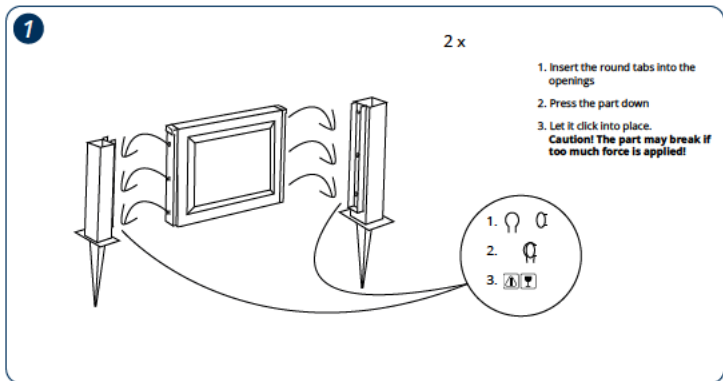

2

2 x

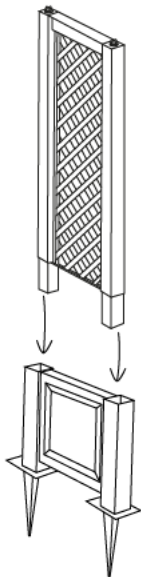

3

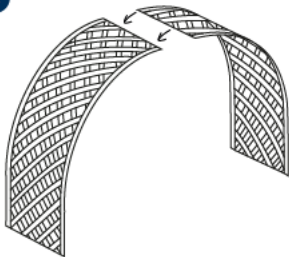

4

2 x

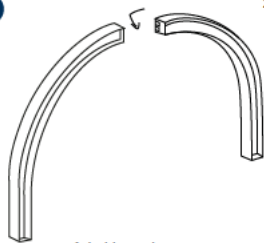

1. hold together
2. plug together

5

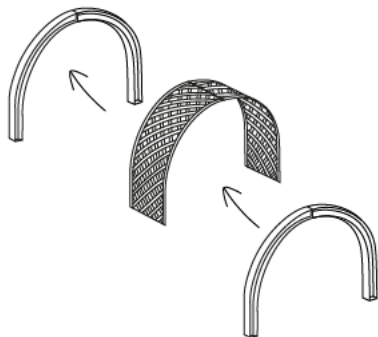

6

1. hold together
2. slide onto the cross dome,
offset and from behind

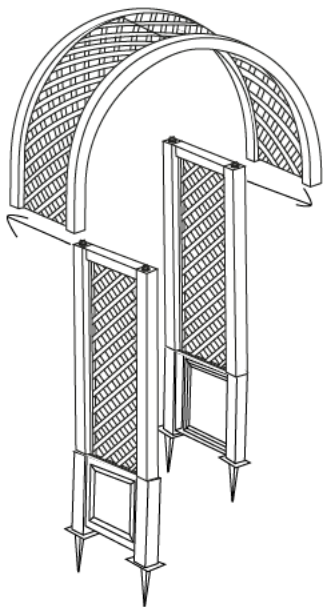

Trellis

Overview of variants



Trellis 43 cm



Trellis 100 cm

content

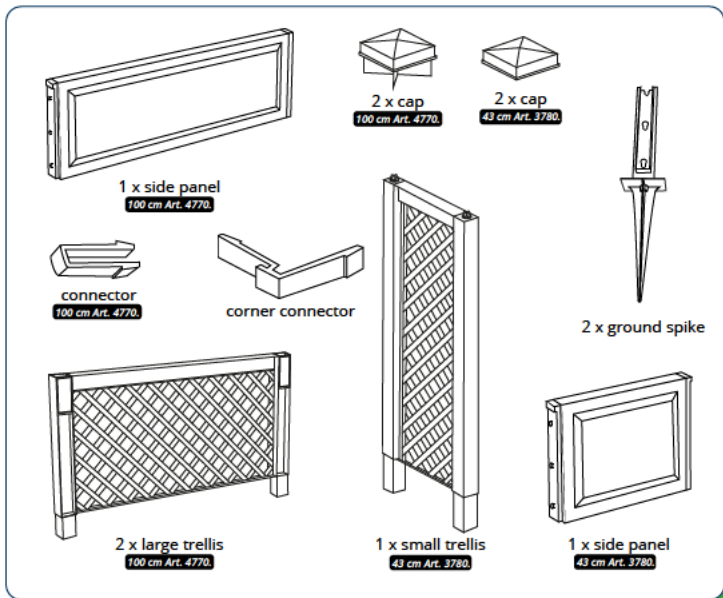

assembly

1

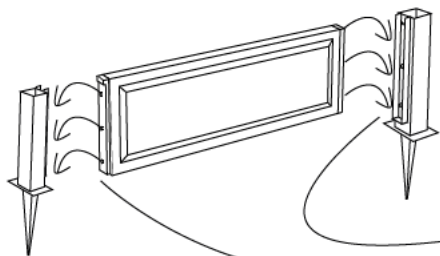

1. Insert the round tabs into the openings
2. Press the part down
3. Let it click into place.
attention! The part may break if too much force is applied!

2

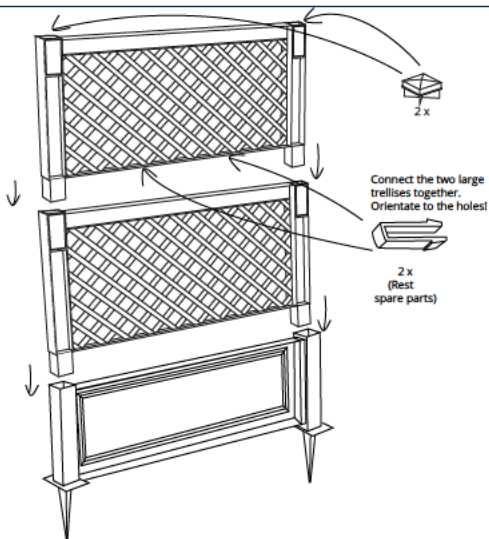

Connect the two large trellises together.
Orientate to the holes!

2 x
(Rest spare parts)

Trellises

Overview of variants



2 x

Attach the sides of the trellises to each other - use the holes as a guide!



2 x

Attach the sides of the trellises to each other - use the holes as a guide!

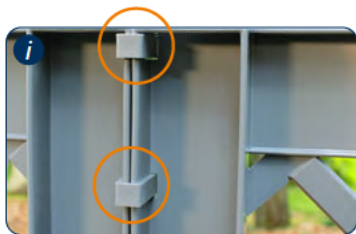
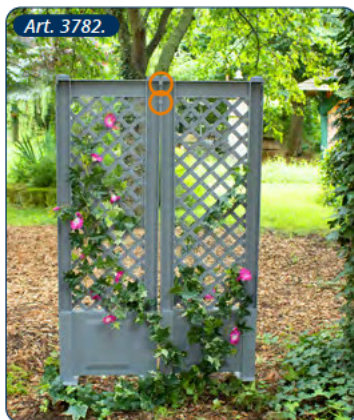

2 x

Attach the sides of the trellises to each other - use the holes as a guide!

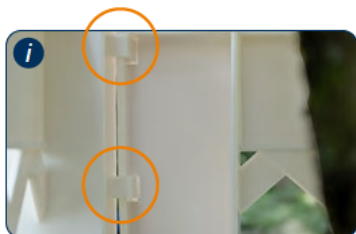

2 x

Attach the sides of the trellises to each other - use the holes as a guide!

Plant and care instructions

Climbing roses

- **Water** the roses **regularly** but not too much.
- Fertilise the plants with **special rose fertiliser**.
- **Wrap** individual shoots around the rose arch and secure them with **small clamps made of plastic, string or wire**.
- **Regularly remove old shoots and wilted flowers**.
- **Prune shoots** that are near to the ground **in spring**, but **don't cut back annual shoots**.

Kletterpflanzen

- Make sure that the plant can take **root deep in the soil**.
- The soil should **hold moisture well**, but **not be susceptible to waterlogging**.
- **Slightly sandy garden soil** that is rich in humus is highly **recommended**.
- Provide the plants with **enough water**.
- **Prune shoots** that are near to the ground **in spring**, but **don't cut back annual shoots**.

We wish you the best of luck!



Just as individual as you are!

In addition to trellises and rose arches, there are also garden benches and planter boxes in the same design that you can coordinate with each other in your garden as desired. **There are no limits to your creativity!**

Are you familiar with ...
our
Demeter raised bed?

Our raised garden bed is made of **100 percent recycled plastic** to help the environment, is **easy to care for**, **weather-proof** and is suitable for every garden thanks to its **simple and timeless design**.

Bon appetit!





We are also the right partner in winter!

On a sled from our **Junior** series, even the youngest children can have fun in the snow.

Later on, the models from the **Classic** range ensure speedy descents on the toboggan slope.

The sledges from the **Adventure** range are an intense experience for young and old.

Our sleds are:

- made in Germany
- TÜV-tested
- free of harmful chemicals
- made of high-quality cold- and light-resistant plastic
- comfortable and ergonomic
- certified with the spiel gut seal*

