

ASSEMBLY INSTRUCTION

WF310372*2

WF310373*2

WF310374*2

Friendly Reminder:

- 1.This sofa is packed in 6 boxes. Please assemble it After all boxes are received.
- 2.As the cushions are all vacuum compressed,there will be some wrinkles. Please give your cushions up to 72 hours to reach its original size and the wrinkles will basically disappear.
- 3.Please do not open the compressed packages until your sofa frame is completely assembled.

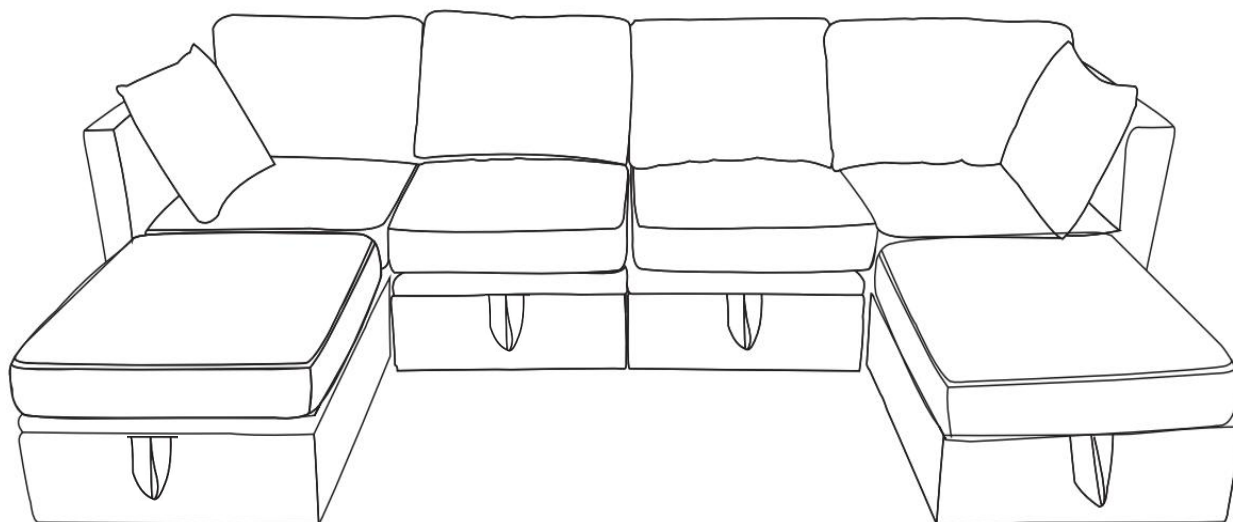





Return & warranty policy



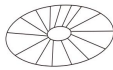

- we strive to offer the highest quality products , and we also try our best to satisfy each and every customer that orders from us with replacement parts or service as needed.
- If the item is damaged or defective , please take photos as evidence for replacements and refunds.
- please do not return to store , contact the seller if you have any troubles with this product.

ASSEMBLY INSTRUCTION

HARDWARE WF310372



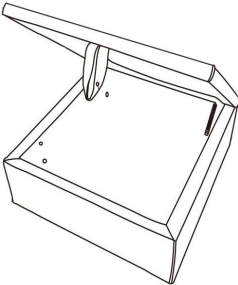
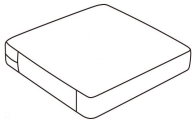

NO	DESCRIPTION	SKETCH	QTY
1	Plastic gasket		4
2	Felt mat		4
3	Screw M6*55MM		8
4	Wrench M6		1

PART LIST WF310372



NO	DESCRIPTION	SKETCH	QTY
A	Main leg		4
B	Armrest pillow		1
C	Backrest pillow		1
D	Backrest or armrest		2
E	Seat frame		1
F	Seat cushion		1

ASSEMBLY INSTRUCTION

HARDWARE WF310373

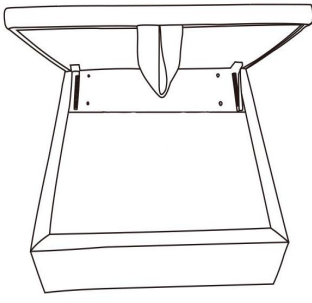
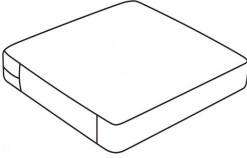

NO	DESCRIPTION	SKETCH	QTY
1	Plastic gasket		4
2	Felt mat		4
3	Screw M6*55MM		4
4	Wrench M6		1
5	U-shaped connector		3

PART LIST WF310373

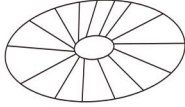

NO	DESCRIPTION	SKETCH	QTY
A	Main leg		4
C	Backrest pillow		1
D	Backrest or armrest		1
G	Seat frame (with a backrest)		1
F	Seat cushion		1

ASSEMBLY INSTRUCTION

HARDWARE WF310374

NO	DESCRIPTION	SKETCH	QTY
1	Plastic gasket		4
2	Felt mat		4



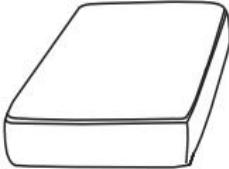

PART LIST WF310374

NO	DESCRIPTION	SKETCH	QTY
A	Main leg		4
H	Ottoman Seat frame		1
I	Ottoman Seat cushion		1

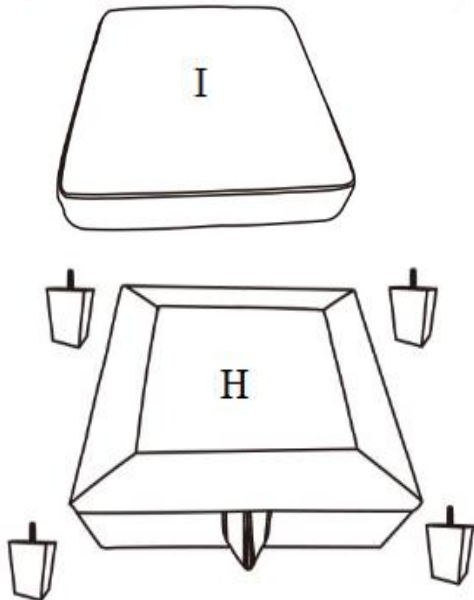
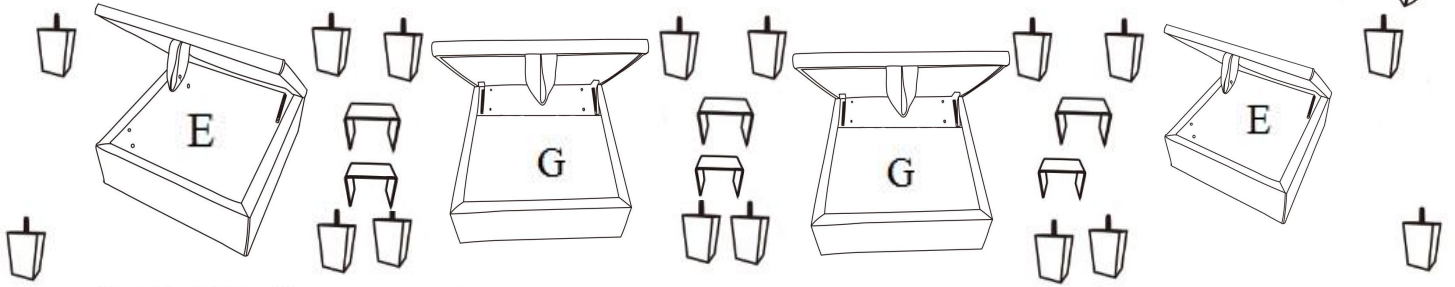
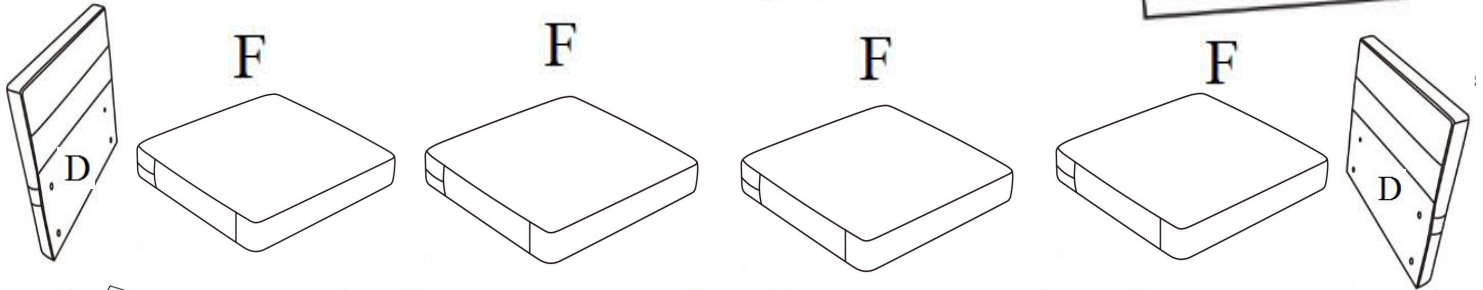
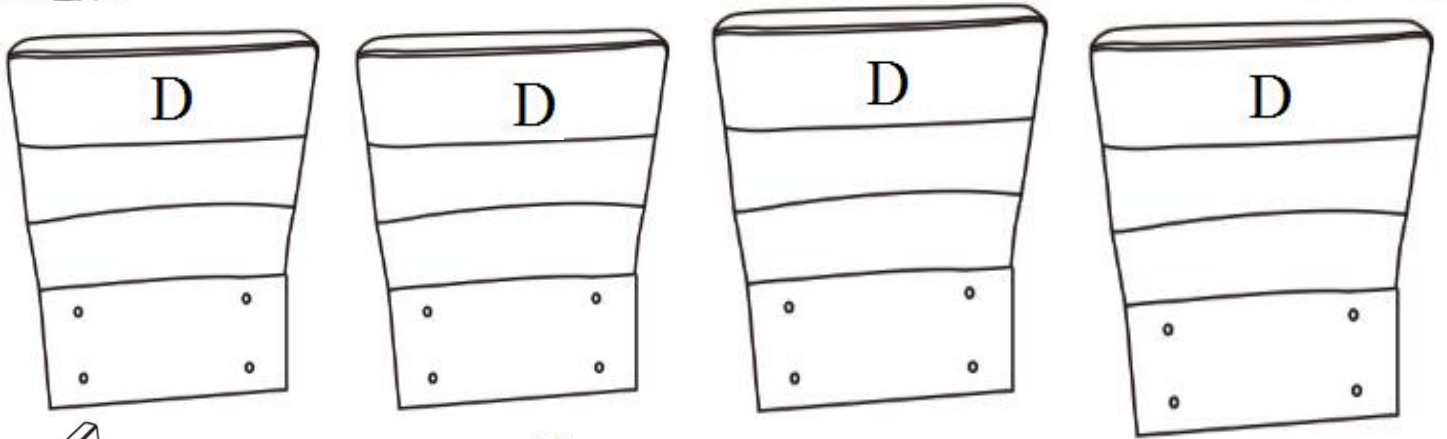
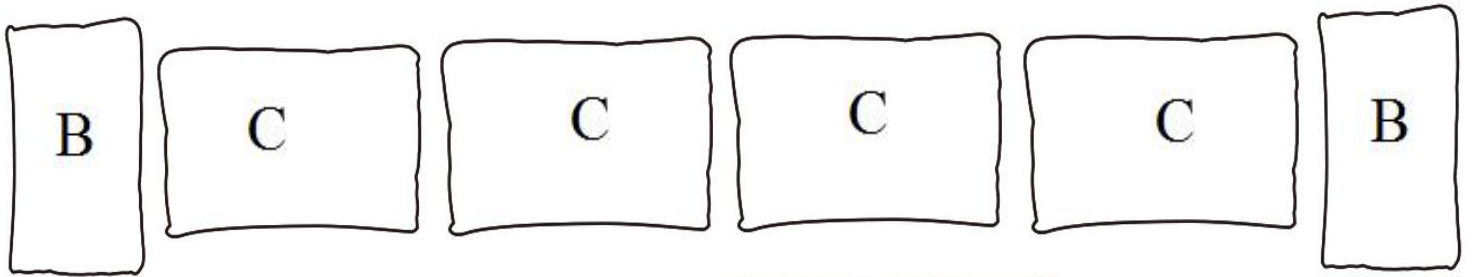
ASSEMBLY INSTRUCTION

All parts and hardwares



1		24
2		24
3		24
4		4

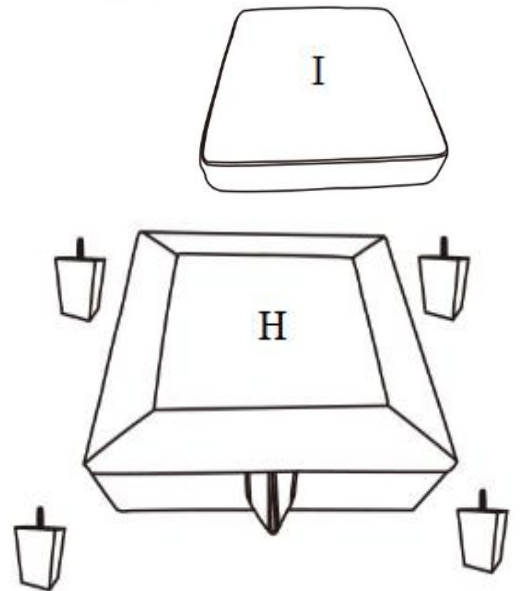

ASSEMBLY INSTRUCTION

WF310372

DIAGRAM 1 (Take out all parts from carton WF310372)

Take the Main legs (Part A), Armrest pillow (Part B), Backrest pillow (Part C), Seat cushion (Part F) out of the Seat frame (Part E).

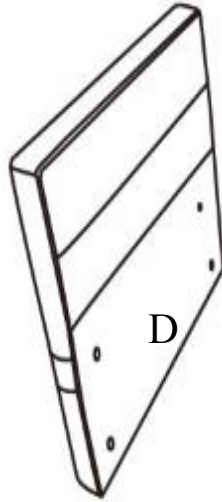
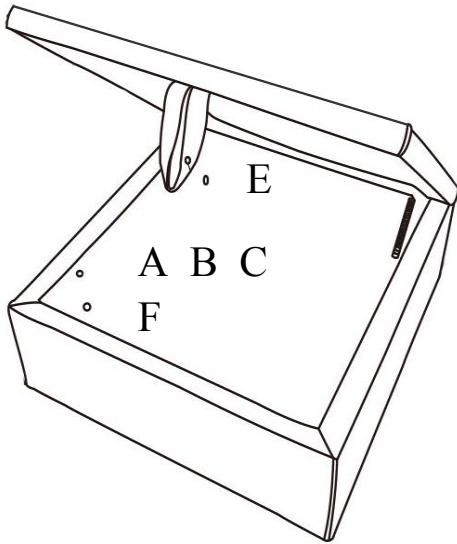







①		4
②		4
③		8
④		1

DIAGRAM 2 (Assemble the Backrest and Armrest)

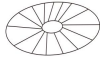
Connect the Seat frame (Part E) and the Armrest (Part D) and the Backrest (Part D) with 8 Screws (HARDWARE 3) and 1 Wrench M6 (HARDWARE 4).

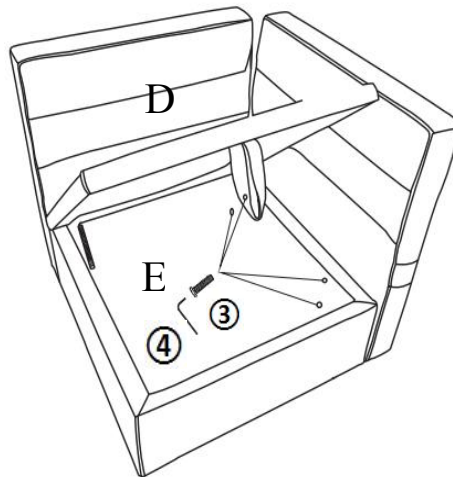
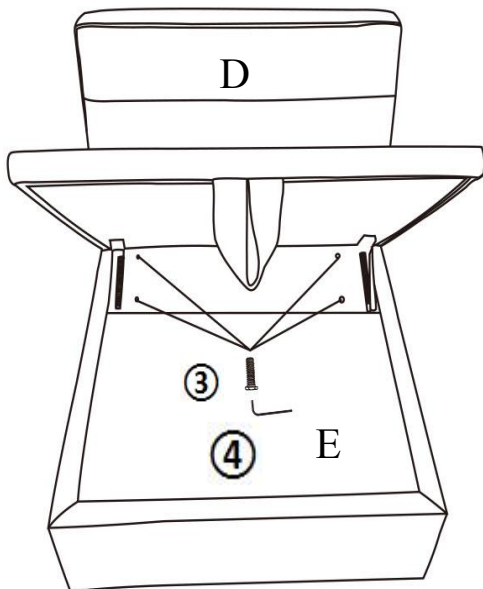

③		8
④		1

Please remember to assemble all the screws to 50% and finally lock them 100% .

ASSEMBLY INSTRUCTION

WF310372

DIAGRAM 3

Use scissors to open the vacuum sealed Seat cushion (Part F). It may take 24-72 hours to fully expand back to its original shape and firmness.

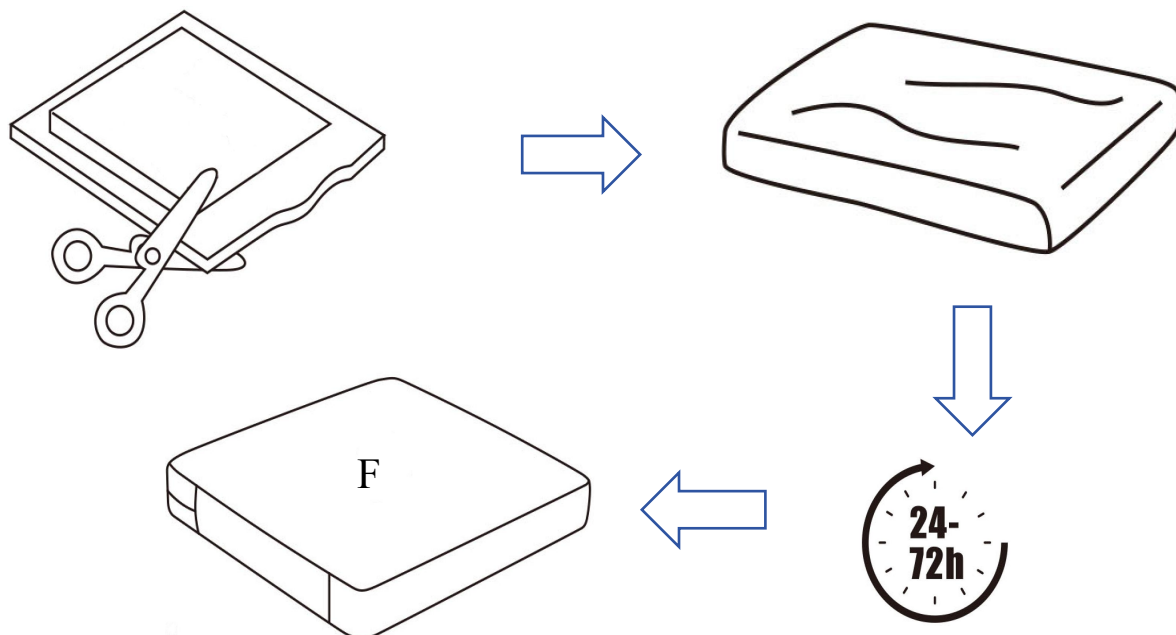
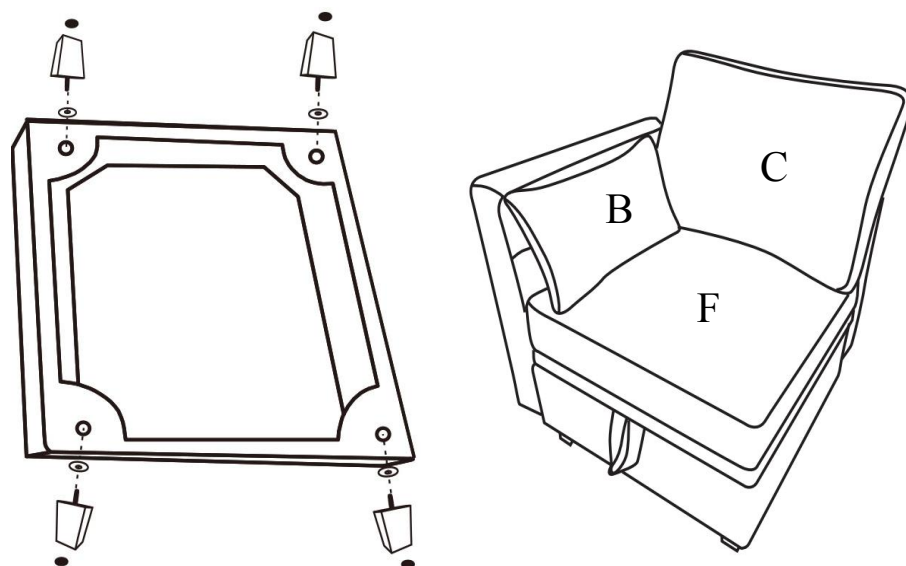





DIAGRAM 4

Tighten Main legs (Part A) by 4 Plastic gaskets (HARDWARE 1) . And then stick the 4 Felt mats (HARDWARE 2) under the Main legs (Part A). Put the Seat cushion (Part F) and Armrest pillow (Part B) and Backrest pillow (Part C) on the seat.



①		4
②		4
A		4

ASSEMBLY INSTRUCTION

WF310373

DIAGRAM 5 (Take out all parts from carton WF310373)

Take the Main legs (Part A), Backrest pillow (Part C), Seat cushion (Part F) out of the Seat frame (with a backrest) (Part G).

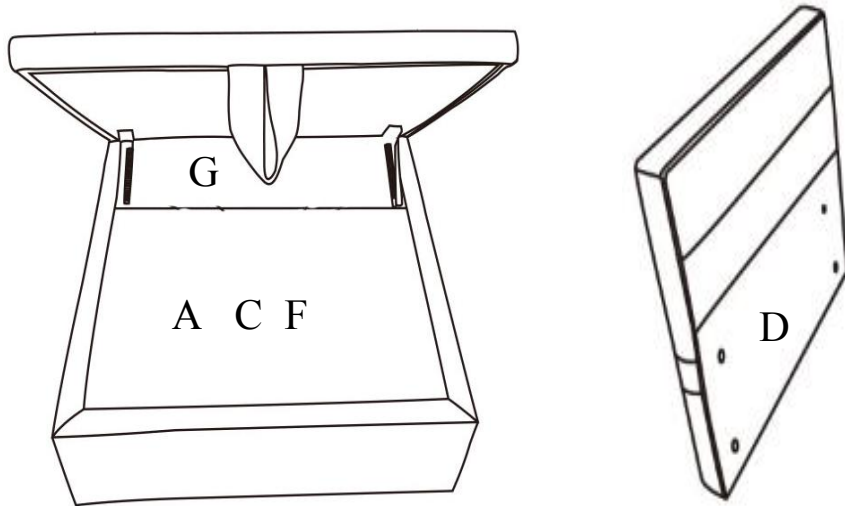







①		4
②		4
③		4
④		1
⑤		3

DIAGRAM 6 (Assemble the Backrest)

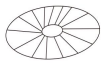
Connect the Seat frame (with a backrest) (Part G) and the Backrest (Part D) with 4 Screws (HARDWARE 3) and 1 Wrench M6 (HARDWARE 4).

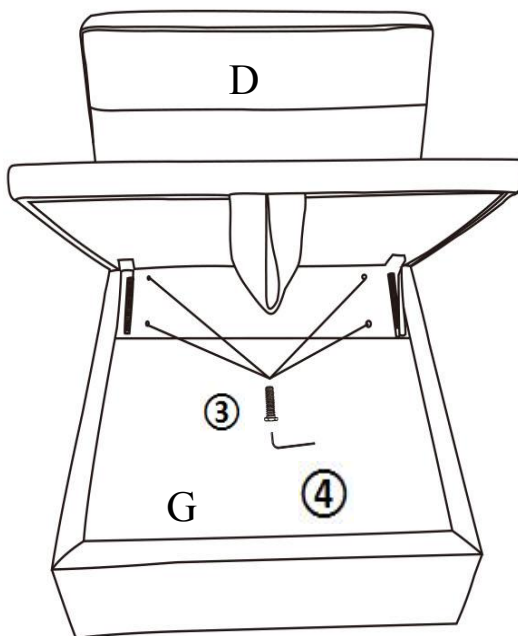

③		4
④		1

Please remember to assemble all the screws to 50% and finally lock them 100% .

ASSEMBLY INSTRUCTION

WF310373

DIAGRAM 7

Use scissors to open the vacuum sealed Seat cushion (Part F). It may take 24-72 hours to fully expand back to its original shape and firmness.

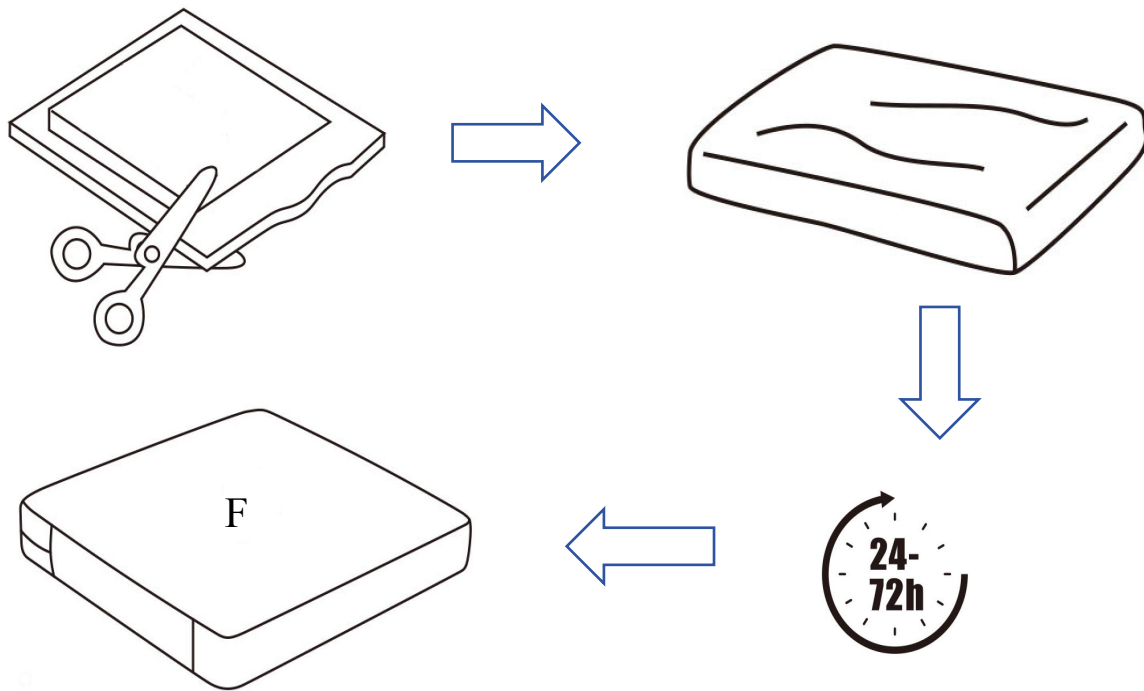
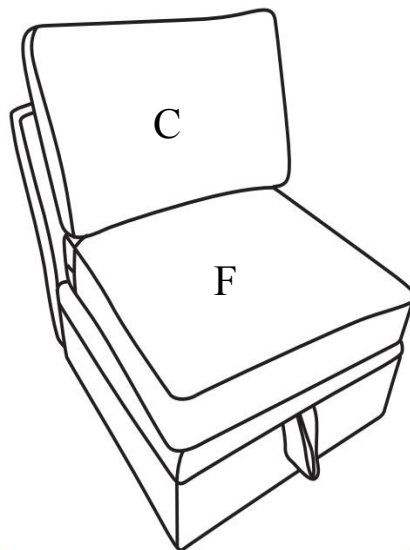
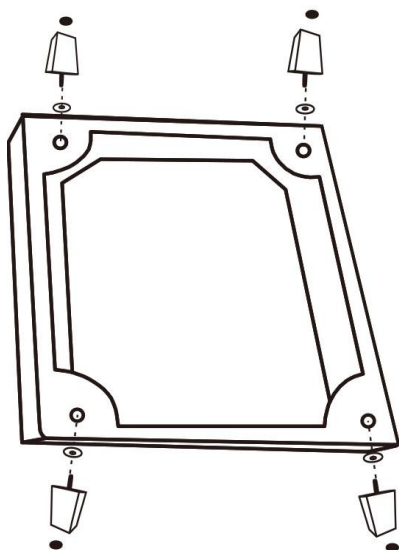

DIAGRAM 8

Tighten Main legs (Part A) by 4 Plastic gaskets (HARDWARE 1). And then stick the 4 Felt mats (HARDWARE 2) under the Main legs (Part A). Put the Seat cushion (Part F) and Backrest pillow (Part C) on the seat.



①		4
②		4
A		4

ASSEMBLY INSTRUCTION

WF310374

DIAGRAM 9 (Take out all parts from carton WF310374)

Take the Main legs (Part A), Ottoman Seat cushion (Part I) out of the Ottoman Seat frame (Part H).

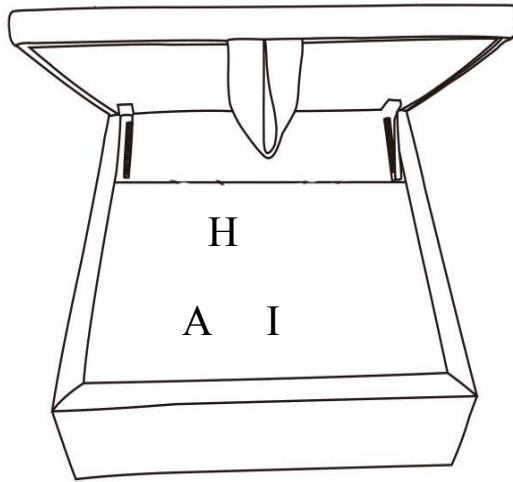



①		4
②		4

DIAGRAM 10

Use scissors to open the vacuum sealed Ottoman Seat cushion (Part I). It may take 24-72 hours to fully expand back to its original shape and firmness.

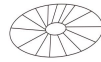

ASSEMBLY INSTRUCTION

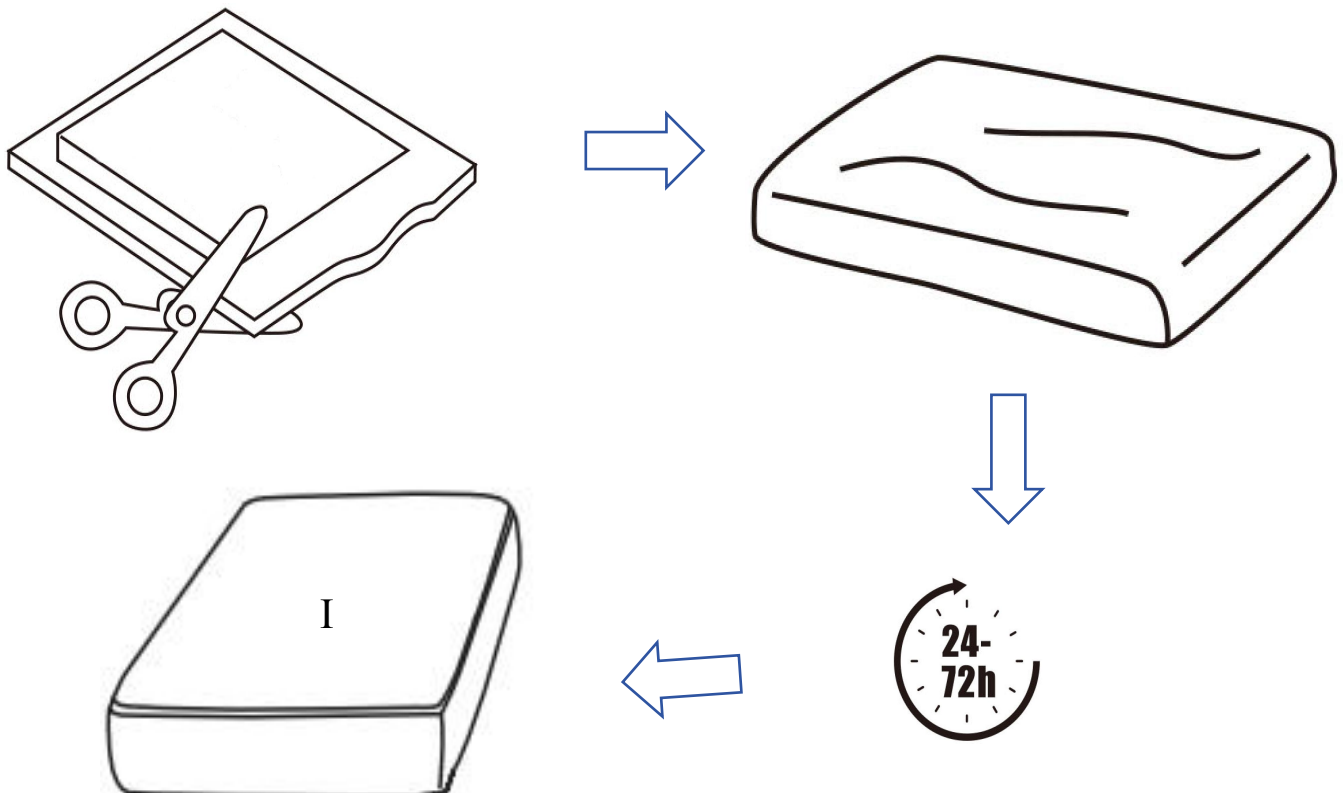
WF310374

DIAGRAM 11

Tighten Main legs (Part A) by 4 Plastic gaskets (HARDWARE 1). And then stick the 4 Felt mats (HARDWARE 2) under the Main legs (Part A).

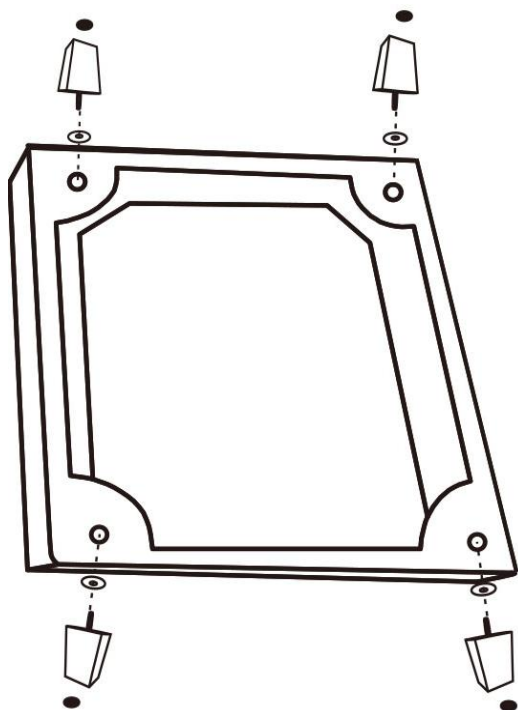



①		4
②		4
A		4

DIAGRAM 12

Put the Ottoman Seat cushion (Part I) on the Ottoman Seat frame (Part H).

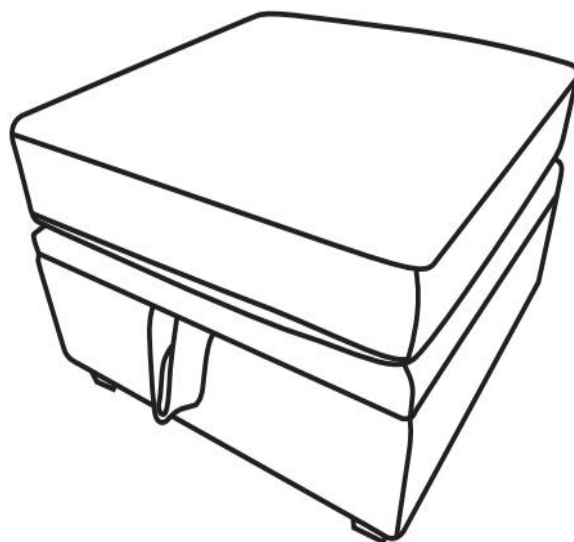
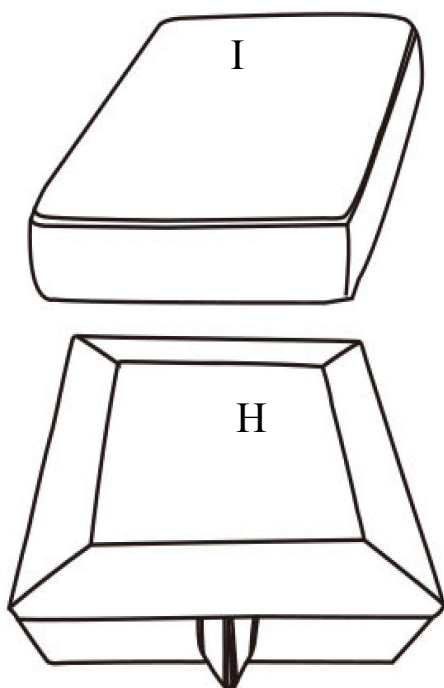

ASSEMBLY INSTRUCTION

WF310372*2

WF310373*2

WF310374*2

DIAGRAM 13



Connect the Seat frame (Part E) and the Seat frame (with a backrest) (Part G) with U-shaped connectors (HARDWARE 5).

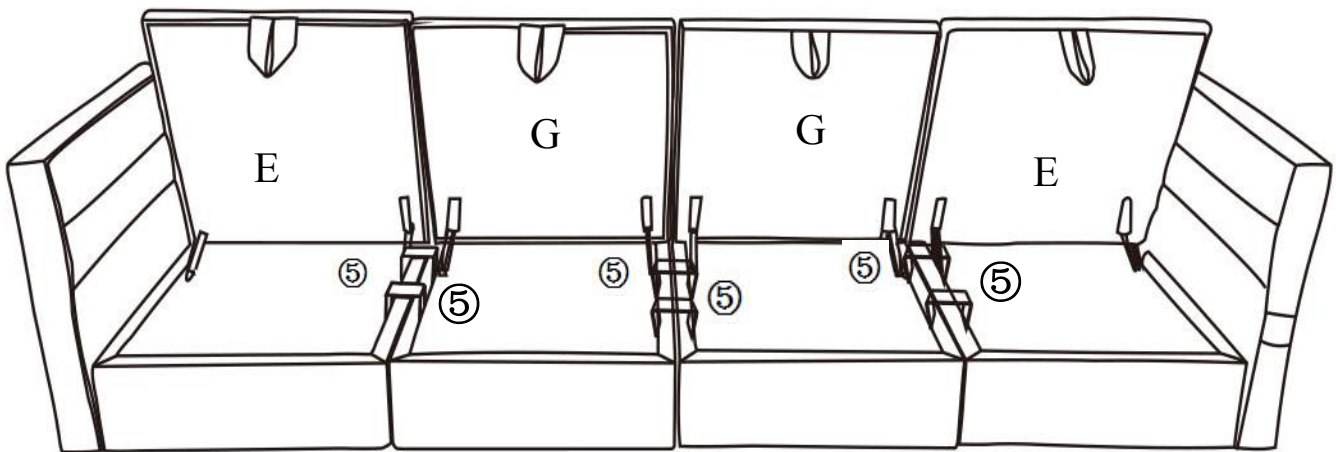
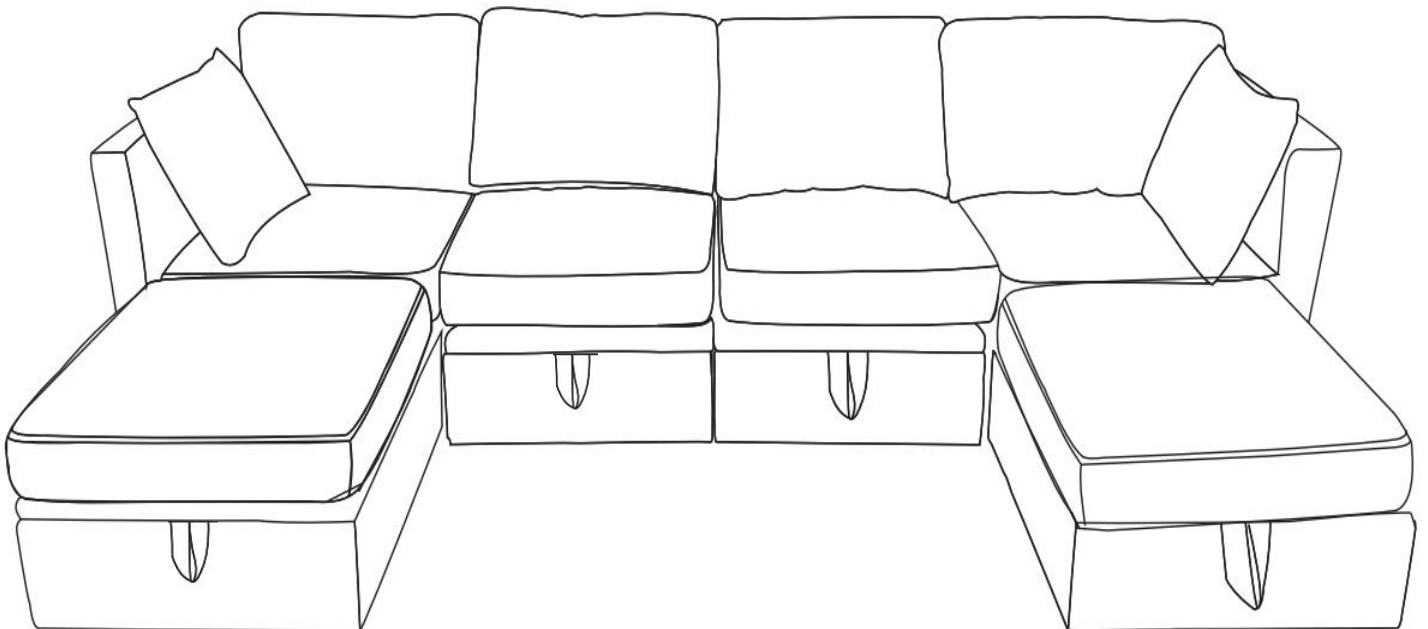

DIAGRAM 14 (Installation is complete)



ASSEMBLY INSTRUCTION

TIPS:

1. Please do not open the compress packaging until your sofa frame is completely assembled.
2. Compress back cushions and pillows need to be fully fulfilled within 72 hours for your perfect use.
3. Please keep children away from plastic bags or any small pieces of stuff.

