





ASSEMBLY INSTRUCTION

HARDWARE LIST			
NO.	PART	DESCRIPTION	Q'TY
A		seat	1
B		frame	1
C		metal gasket	4
D		screw	4
E		Allen key	1



step 1

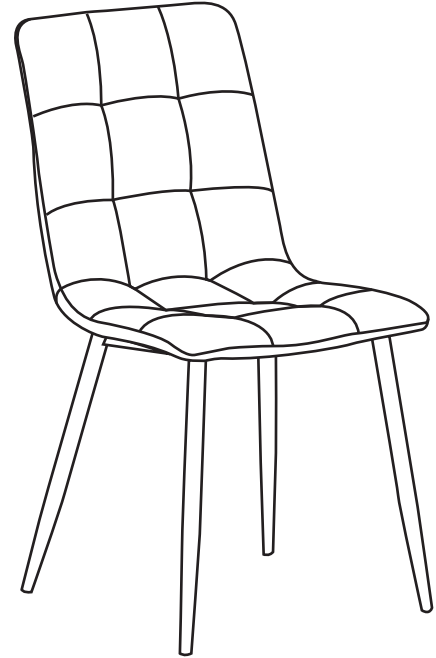
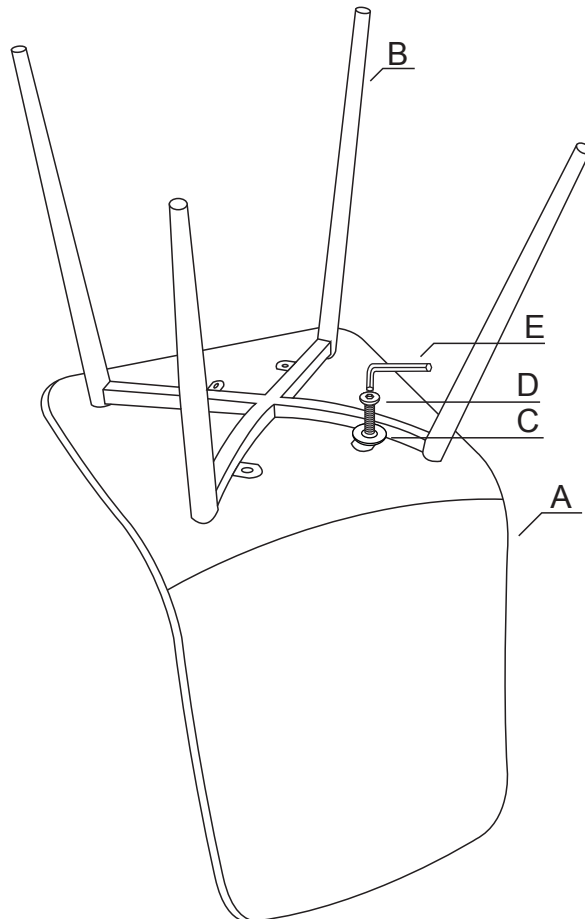

step 2

