

Instruction Manual

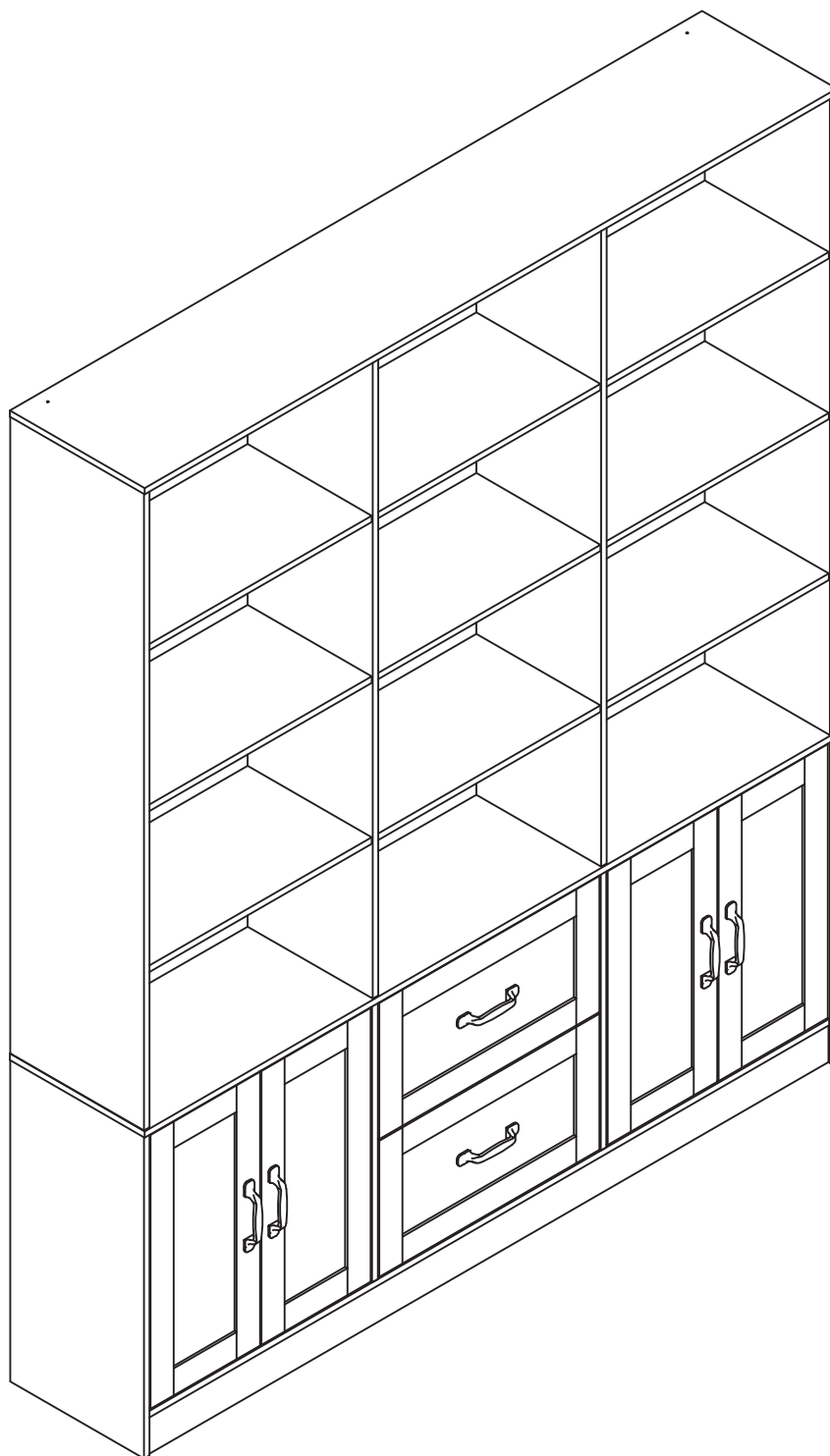

V1.0

Cabinet

EN

Thank you for purchase on our products. Please contact us if you have difficulty with assembly or need replacement parts. Our customer service is here to assist you. Please attach your User Name or Order ID so that we can assist you better.

WARNING

Serious or fatal injury may occur from unexpected assembly or use.

1. During the assembly process, keep all parts away from babies or children.
2. Always securely fix this product to the wall. Make sure the wall area to be drilled is free from hidden electrical wires, water and gas pipes.
3. Use of tip-over restraints may only reduce, but not eliminate the risk of tip-over.
4. Unless specially designed to accommodate, do not set heavy objects on top of this product.
5. Place the heaviest items on the lowest shelf.
6. Never allow children to climb or bang on drawers, doors or shelves.

DE

Vielen Dank für Ihren Kauf von uns Produkten. Bitte kontaktieren Sie uns, wenn Sie Probleme mit Montage haben oder Ersatzteile benötigen. Wir Kundenservice ist für Sie da. Bitte geben Sie Ihren Benutzernamen oder Ihre Bestellnummer an, damit wir Sie besser unterstützen können.

WARNUNG



Bei unerwarteter Montage oder Verwendung können schwere oder tödliche Verletzung auftreten.

1. Legen Sie in den Montageprozess alle Teile weg von Babys oder Kindern.
2. Stellen Sie sicher, dass der gebohrte Wandbereich frei von verborgenen Stromkabeln, Wasser- und Gasleitungen ist, wenn Sie dieses Produkt an der Wand befestigen.
3. Die Verwendung von Kippsicherungen kann die Gefahr eines Kippens nur verringern, jedoch nicht beseitigen.
4. Setzen Sie bitte keine schweren Gegenstände auf dieses Produkt, es sei denn, dass das Produkt speziell für die Unterbringung konzipiert wird.
5. Legen Sie bitte die schwersten Gegenstände auf das unterste Regal.
6. Erlauben Sie nie Kindern, auf Schubladen, Türen oder Regale zu klettern oder zu knallen.

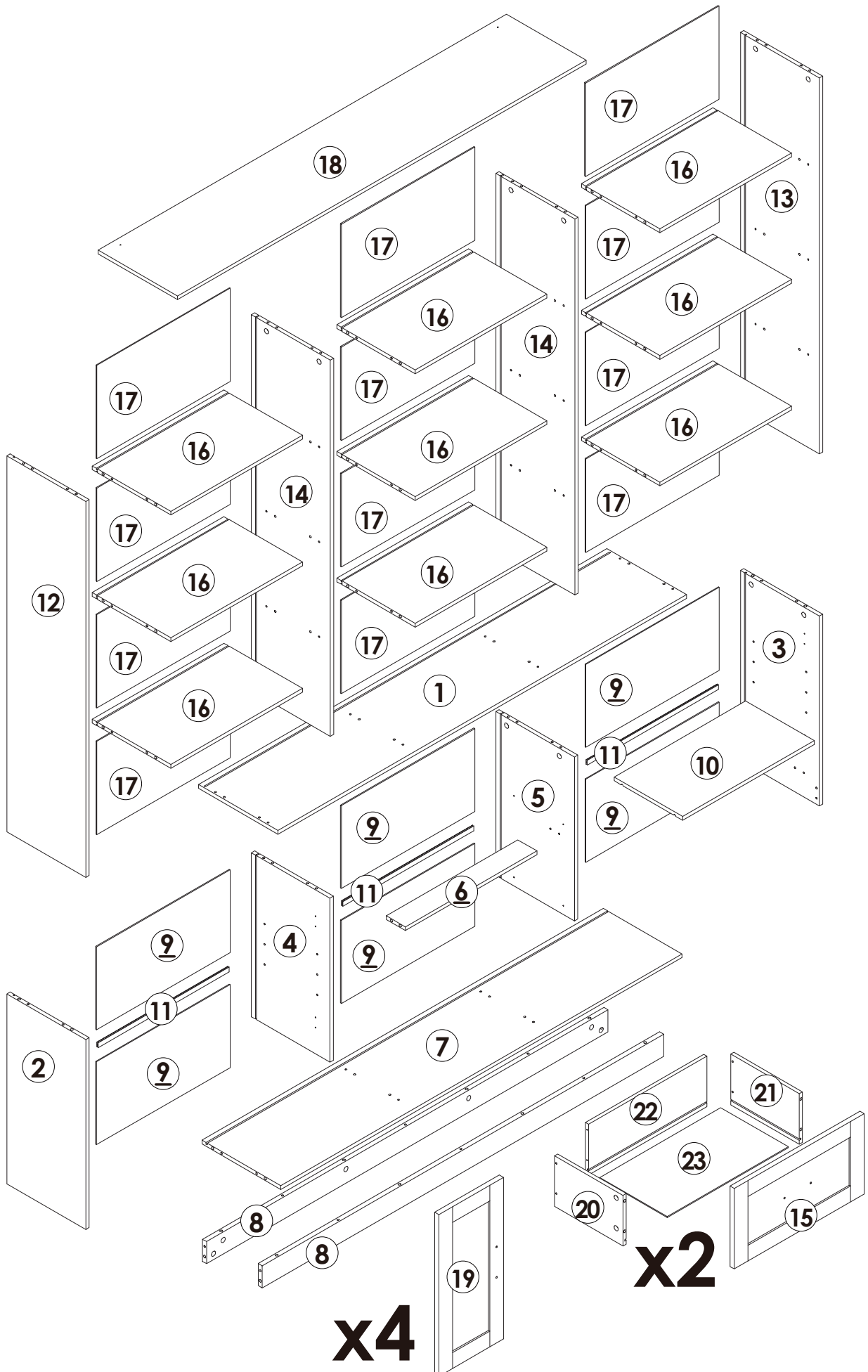
Parts List(EN) / Teile Liste(DE)





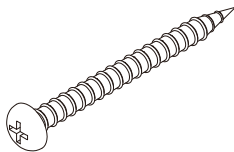
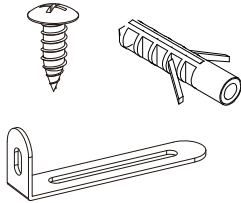
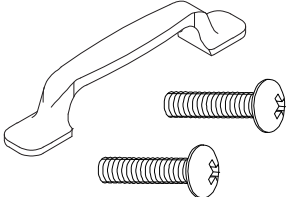
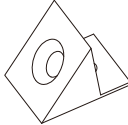
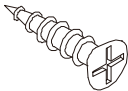
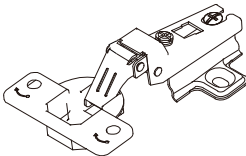
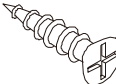
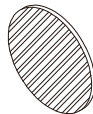
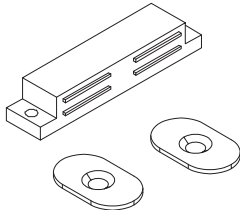
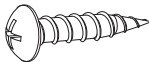
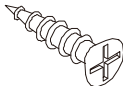
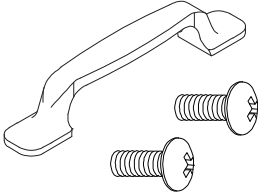
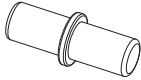
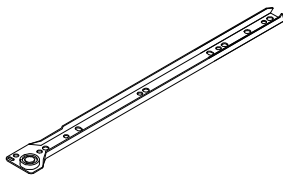
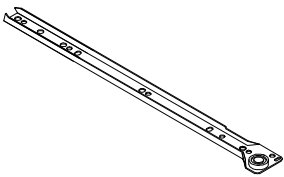
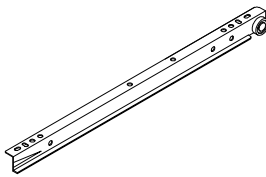
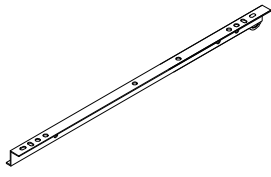

Parts List(EN) / Teile Liste(DE)

A 	B 	C 	D 
M6×33mm 80+2PCS	Ø15×9mm 80+2PCS	Ø6×30mm 78+2PCS	M4×33mm 22+2PCS
E 	F 	G 	H 
M4×12mm 2SETS	M4×19mm 4SETS	32+2PCS	M4×14mm 32+2PCS
I 	J 	K 	L 
8PCS	M3.5×12mm 52+2PCS	Ø20mm 8+1PCS	2SETS
M 	N 	O 	P 
M3×14mm 4PCS	M3×12mm 4PCS	M4×9mm 2SETS	Ø6×15mm 4PCS
CL 	CR 	DL 	DR 
L250mm 2PCS	L250mm 2PCS	L250mm 2PCS	L250mm 2PCS

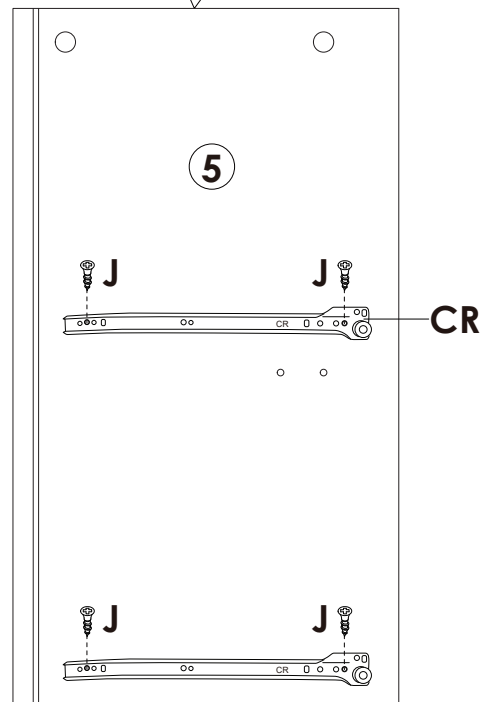
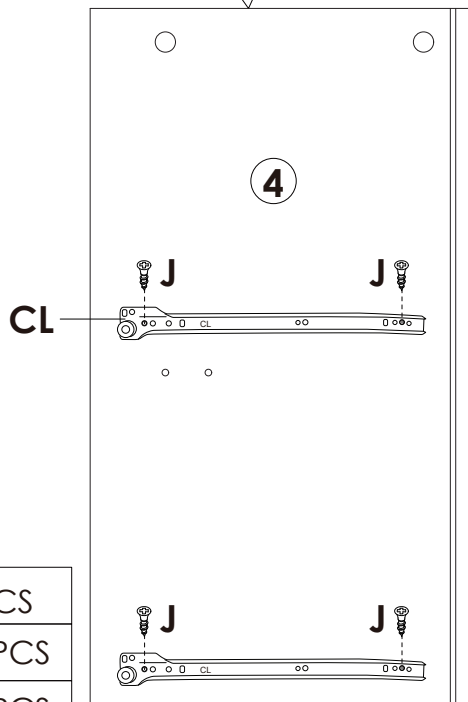
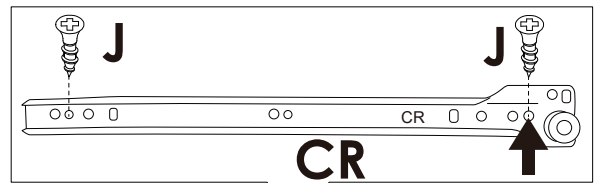
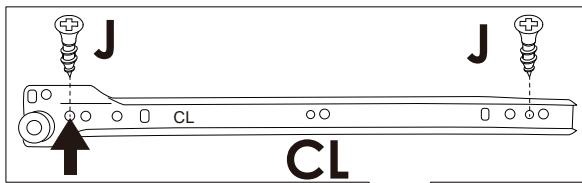
Assembly Steps(EN) / Montageschritte(DE)

STEP 1



	J x 8PCS
	CL x 2PCS
	CR x 2PCS

STEP 2

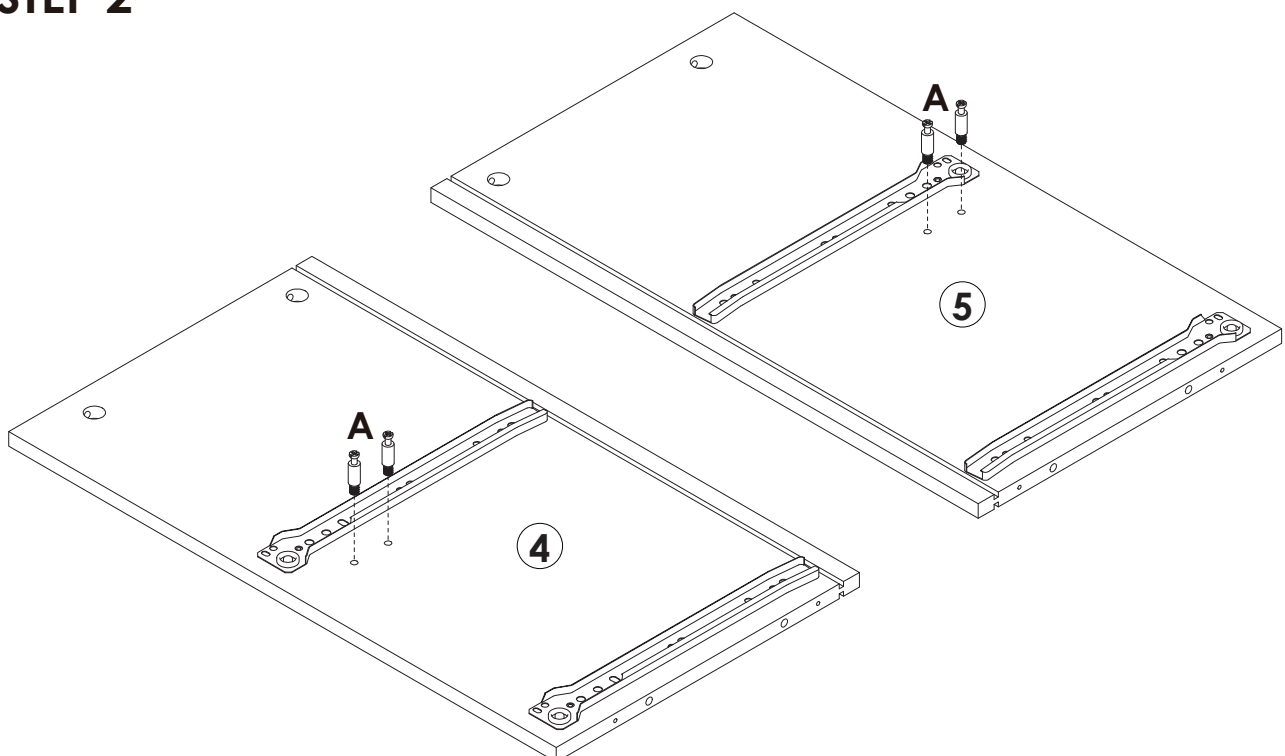

	A x 4PCS
---	----------

Assembly Steps(EN) / Montageschritte(DE)

STEP 3

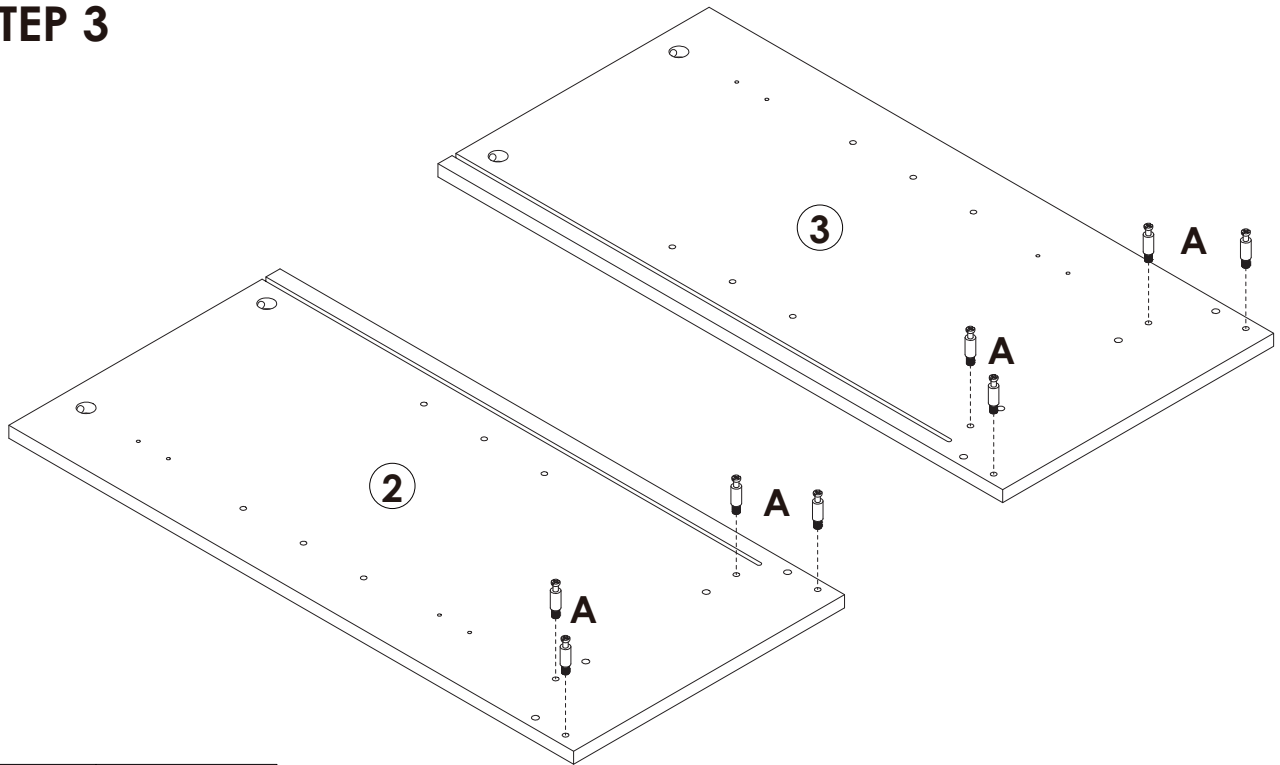

 **A x 8PCS**

STEP 4

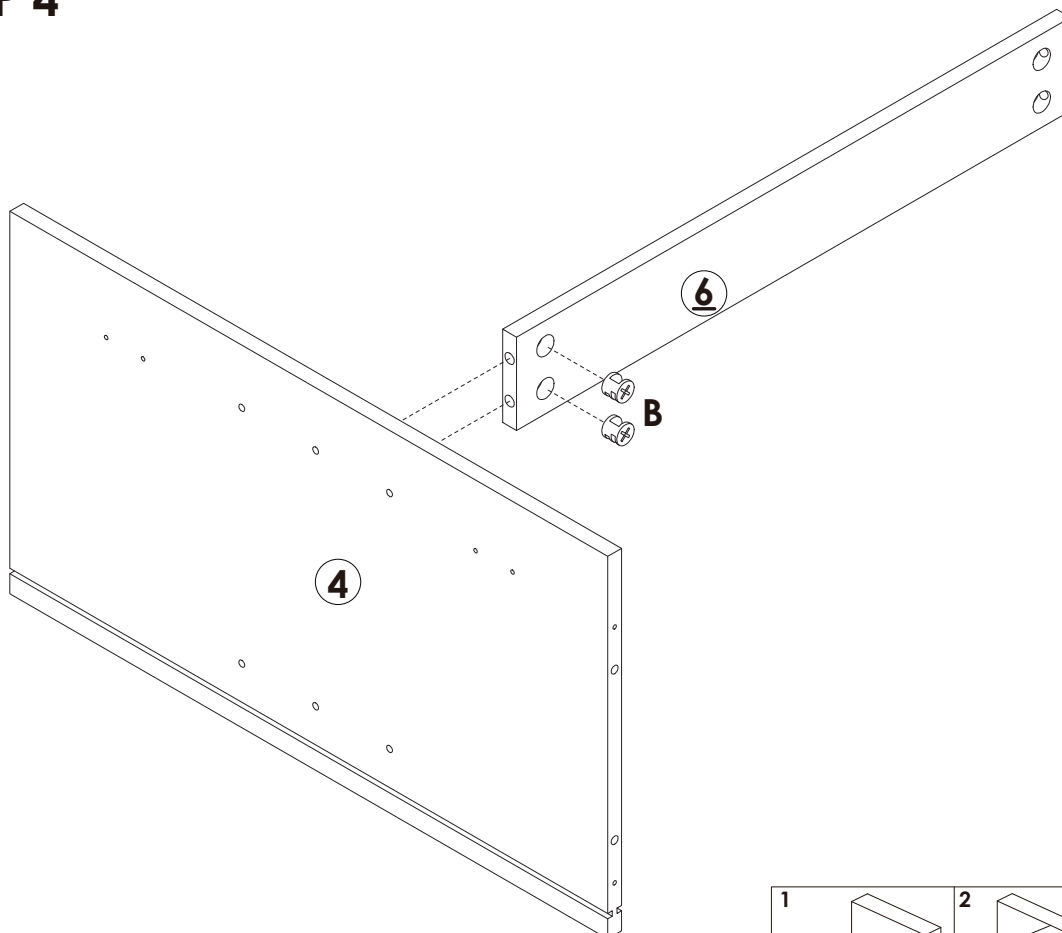

 **B x 2PCS**

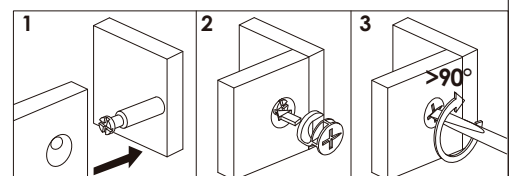

Assembly Steps(EN) / Montageschritte(DE)

STEP 5

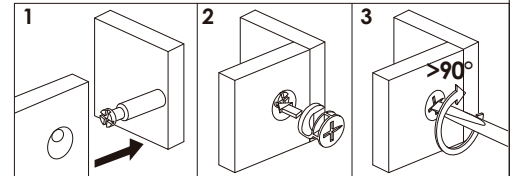
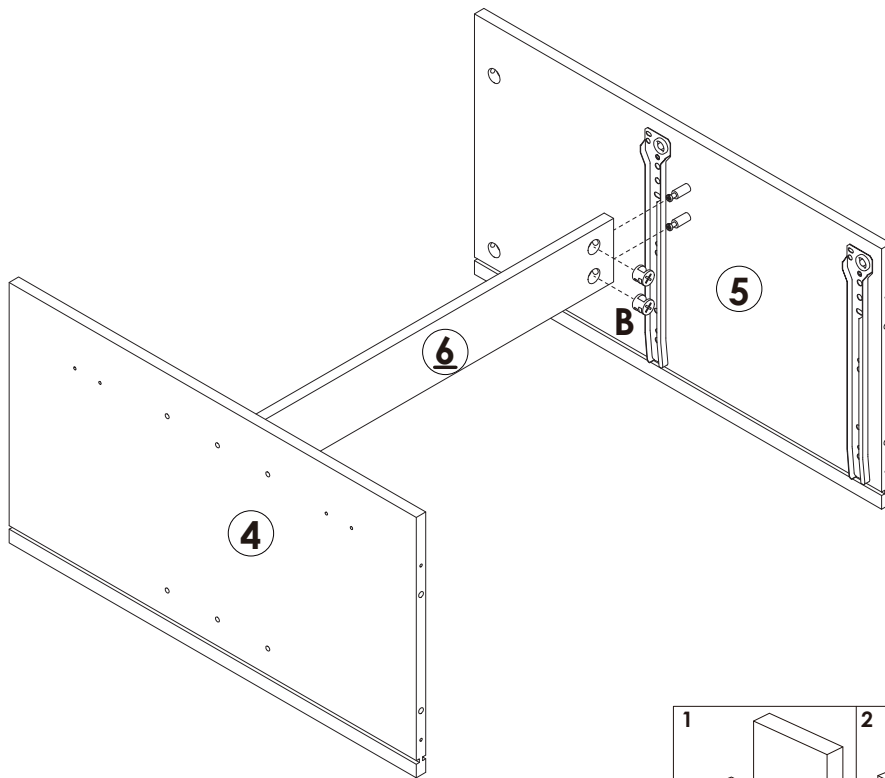

B x 2PCS

STEP 6

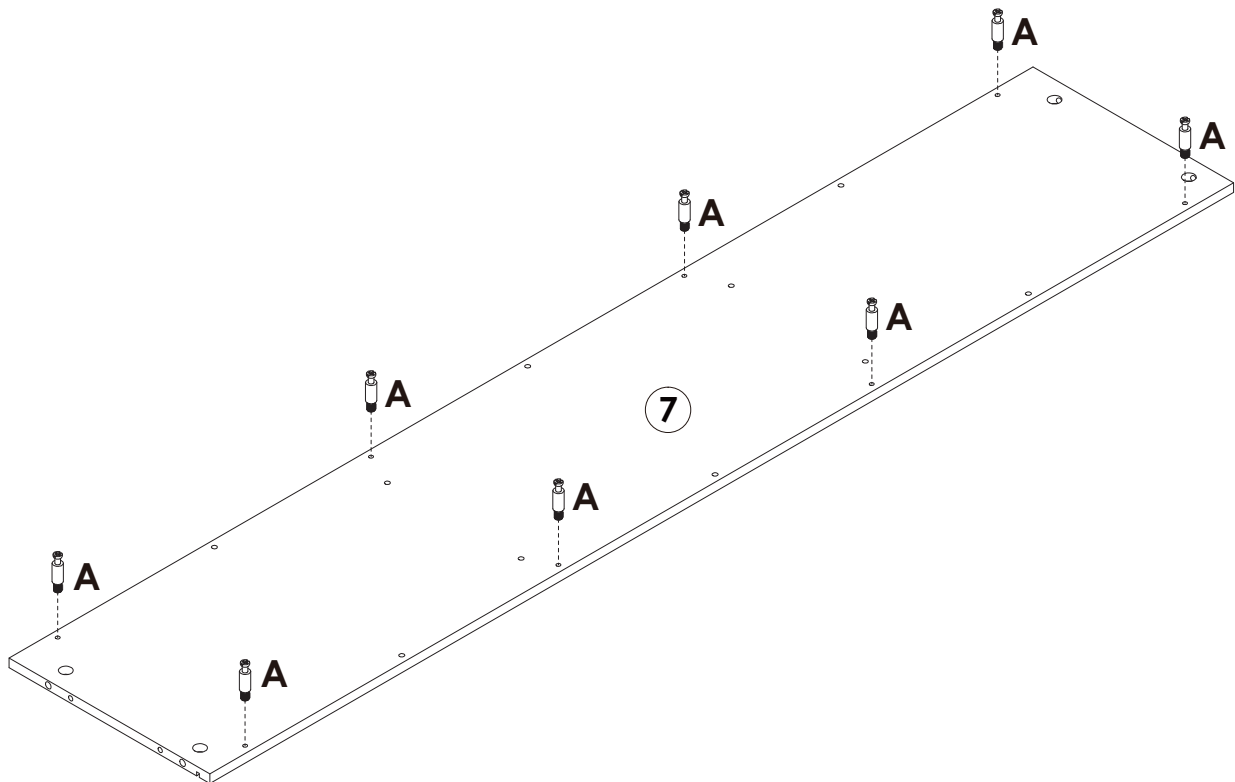



A x 8PCS

Assembly Steps(EN) / Montageschritte(DE)

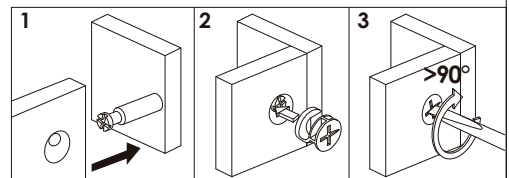
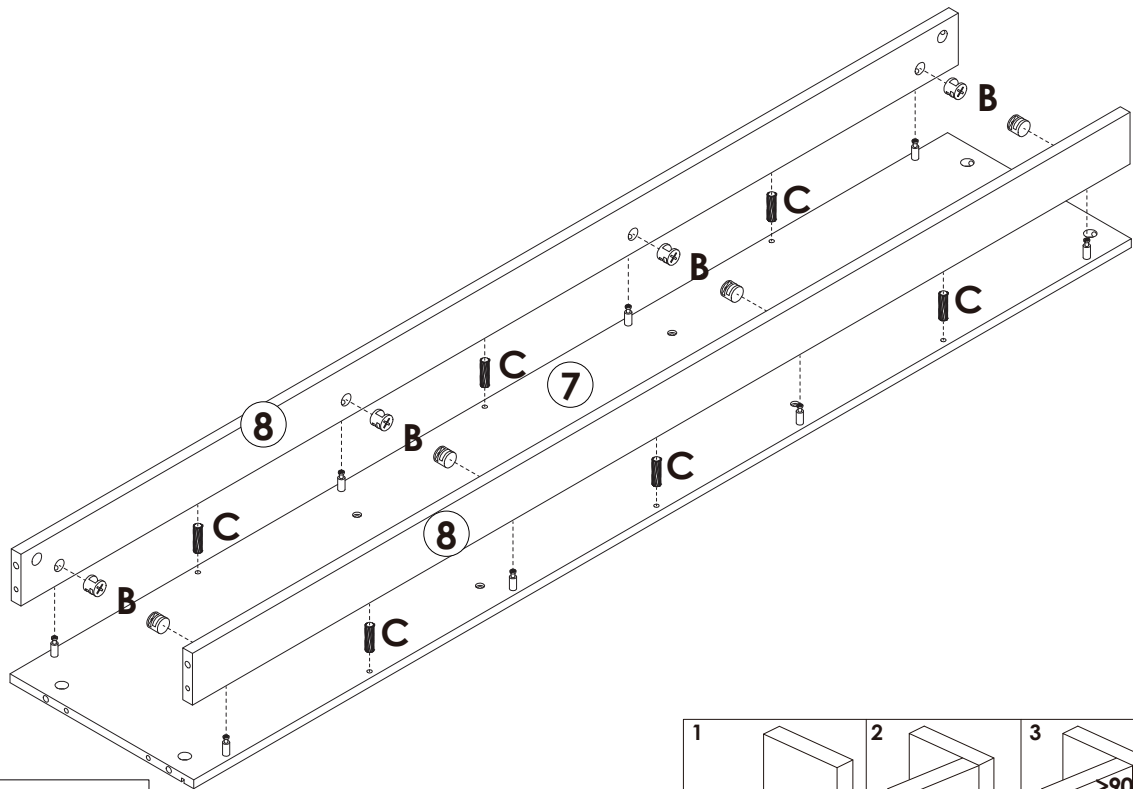

STEP 7

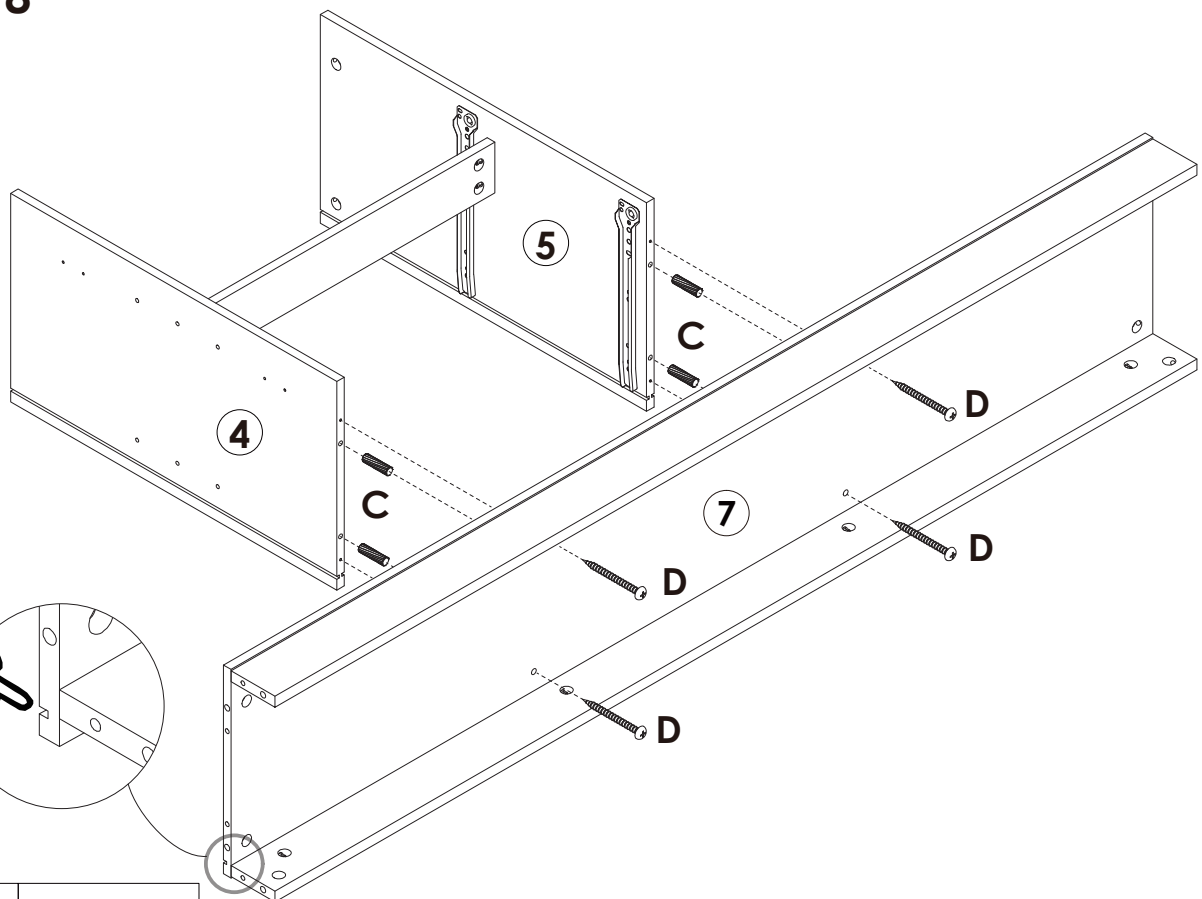

	B x 8PCS
	C x 6PCS

STEP 8





	C x 4PCS
	D x 4PCS

Assembly Steps(EN) / Montageschritte(DE)

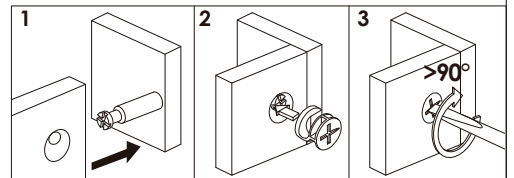
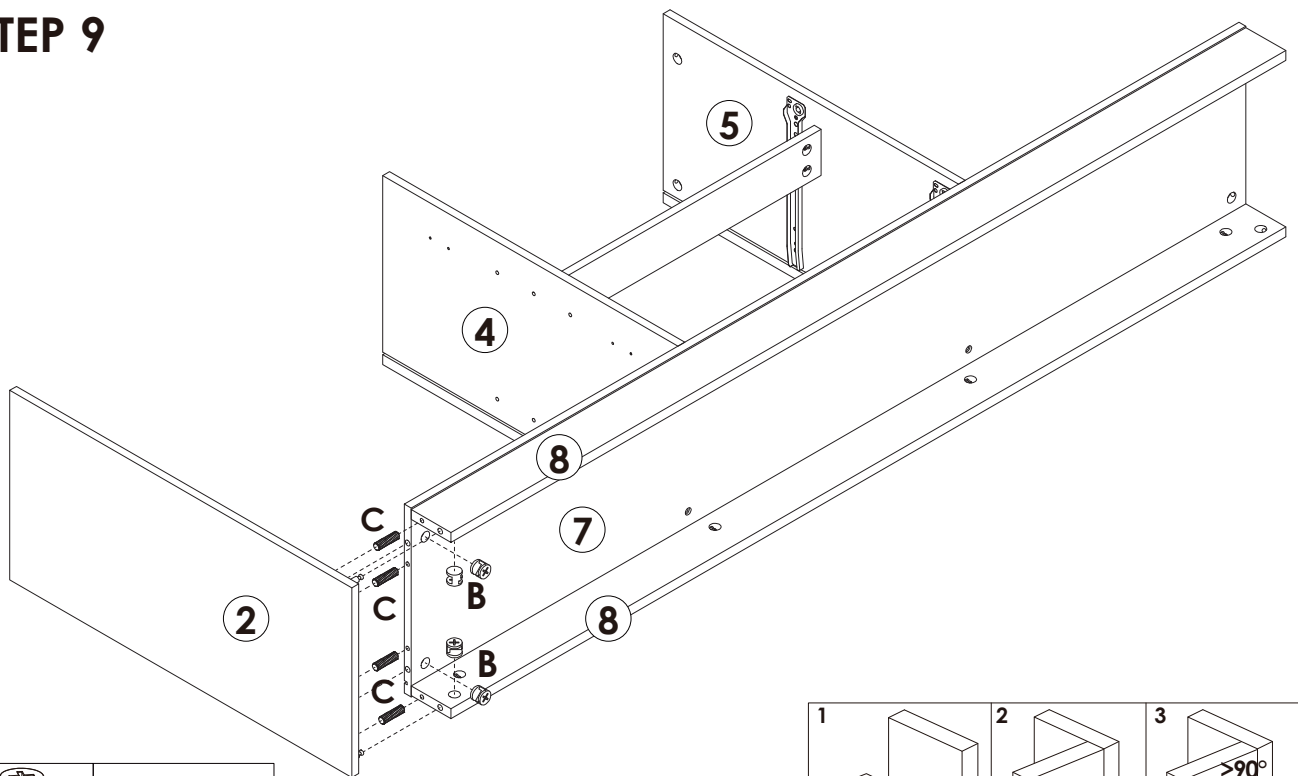

STEP 9

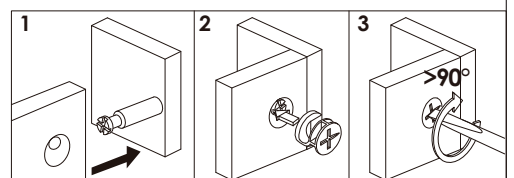
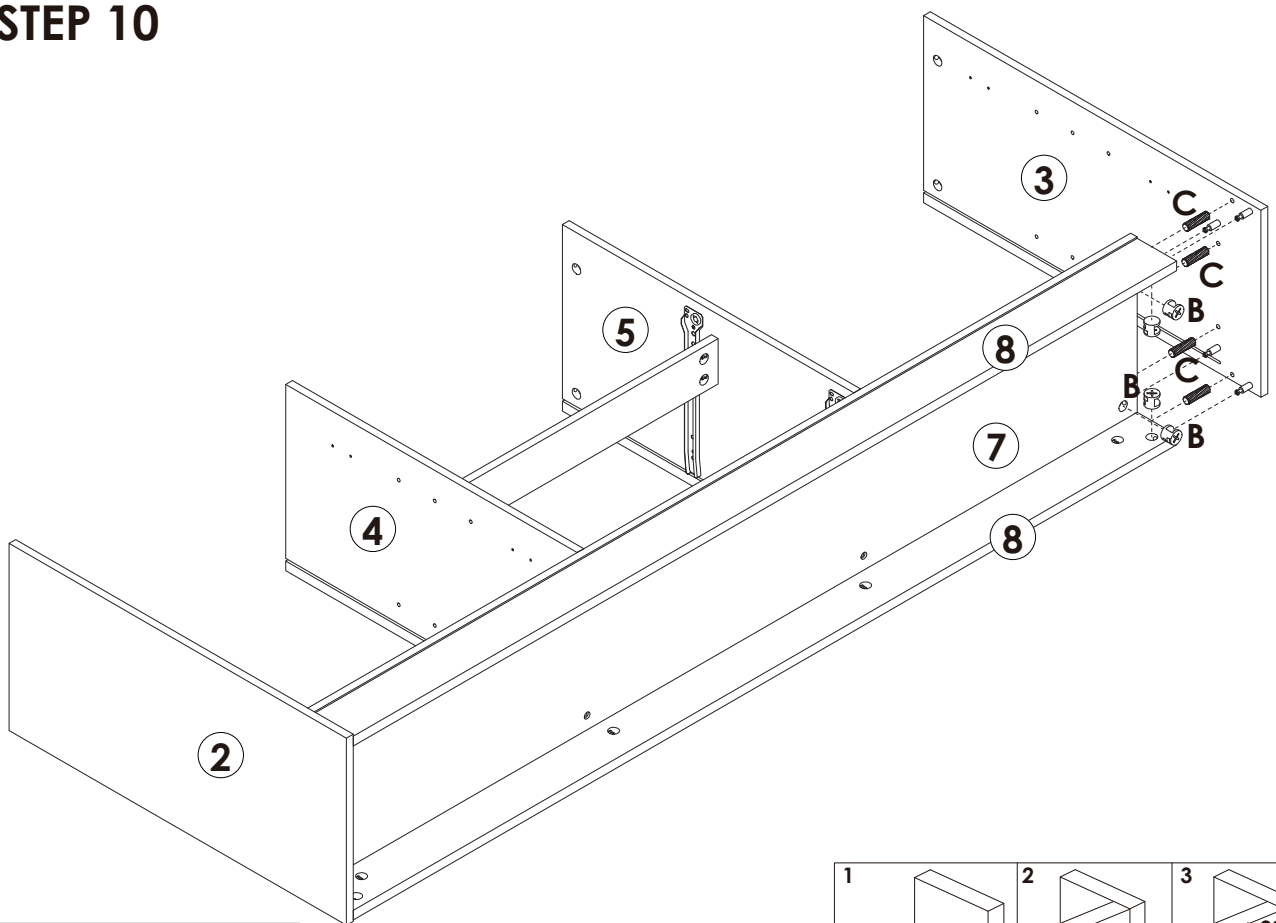

	B x 4PCS
	C x 4PCS

STEP 10



	B x 4PCS
	C x 4PCS

Assembly Steps(EN) / Montageschritte(DE)

STEP 11

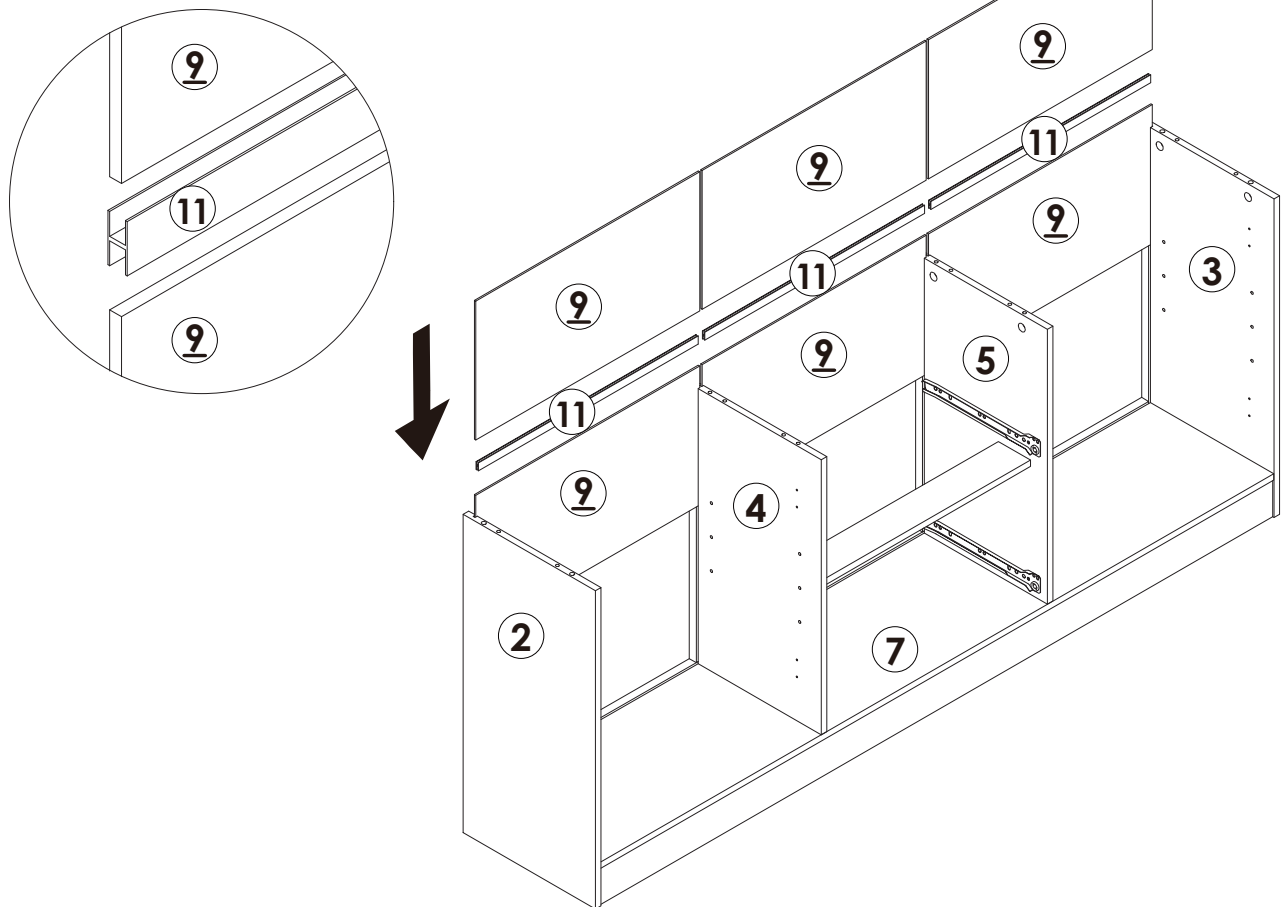

STEP 12

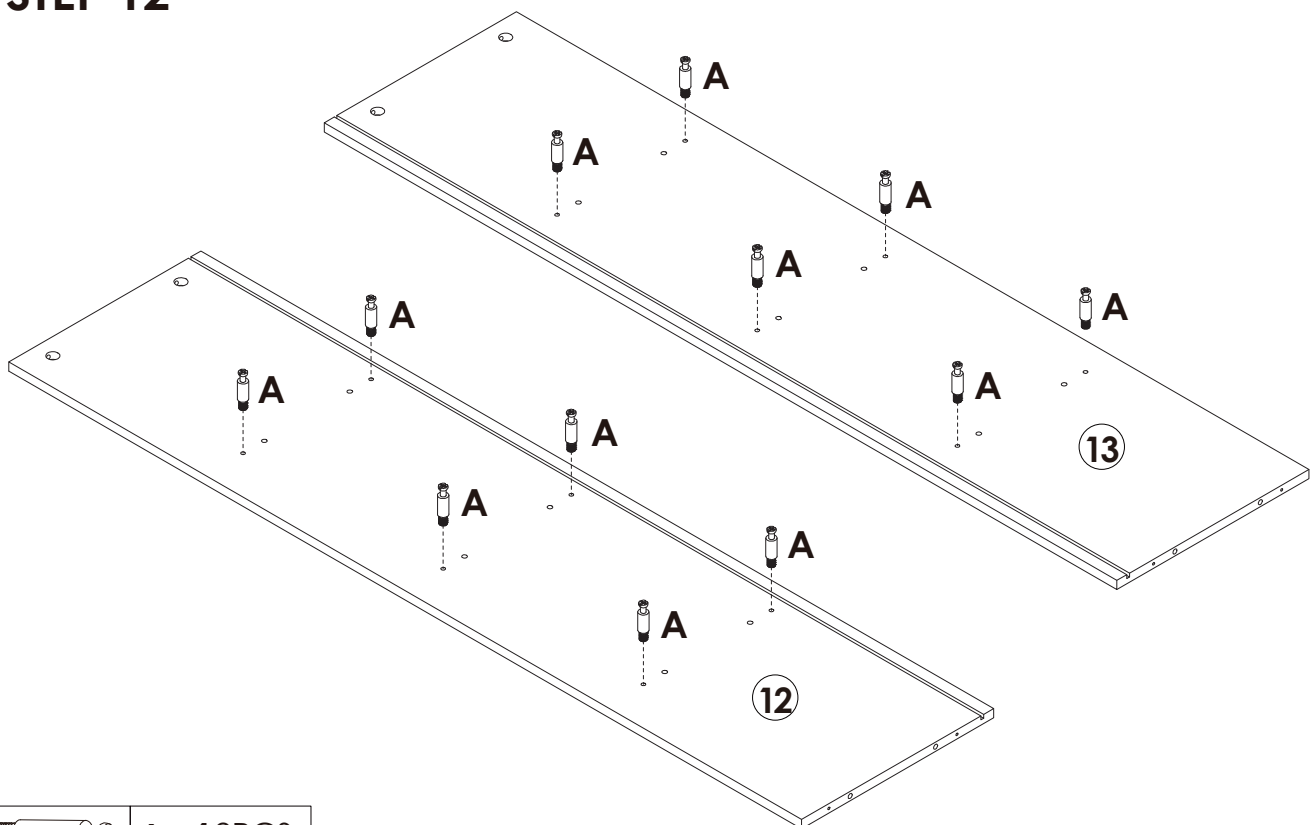

 A x 12PCS

Assembly Steps(EN) / Montageschritte(DE)

STEP 13

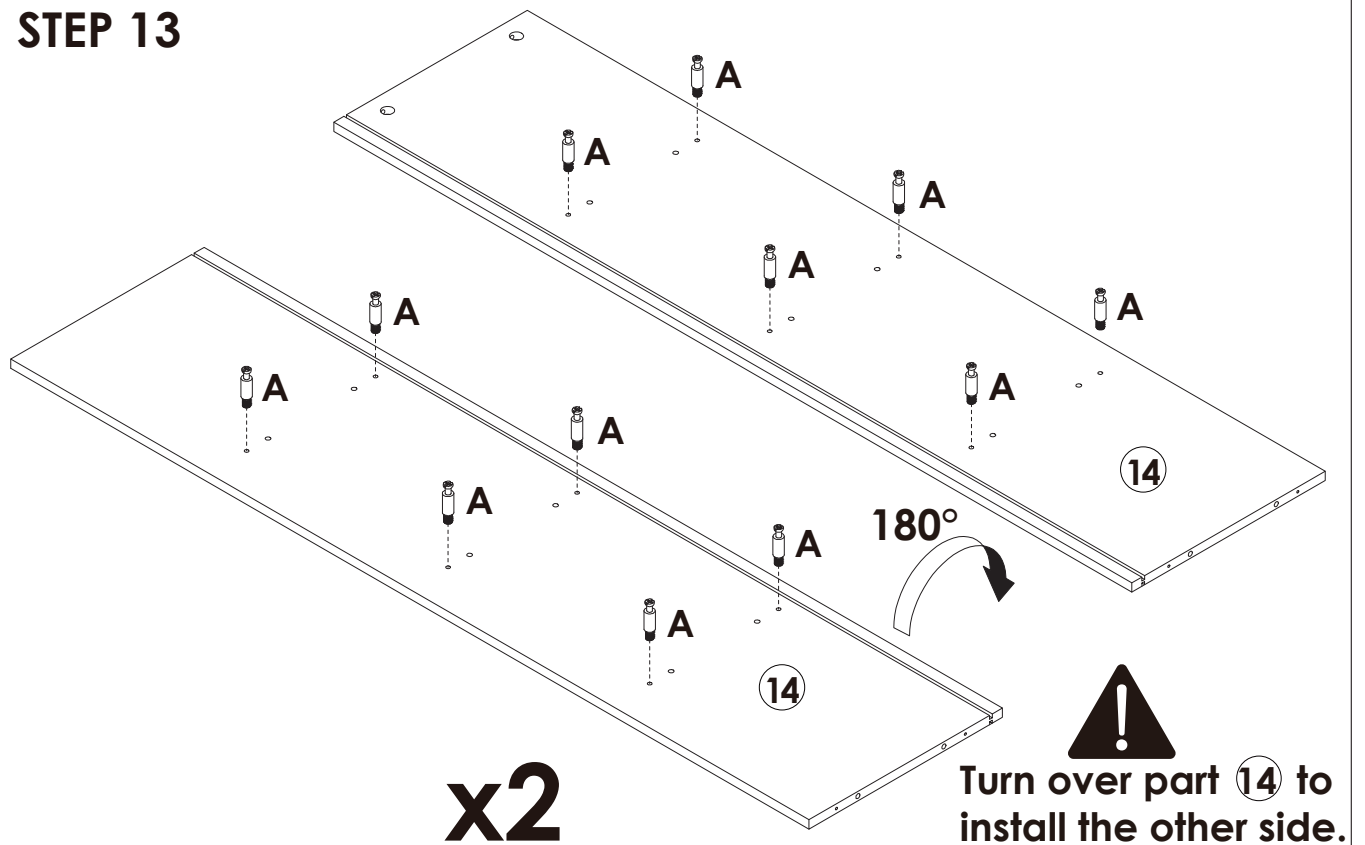

 A x 24PCS

STEP 14

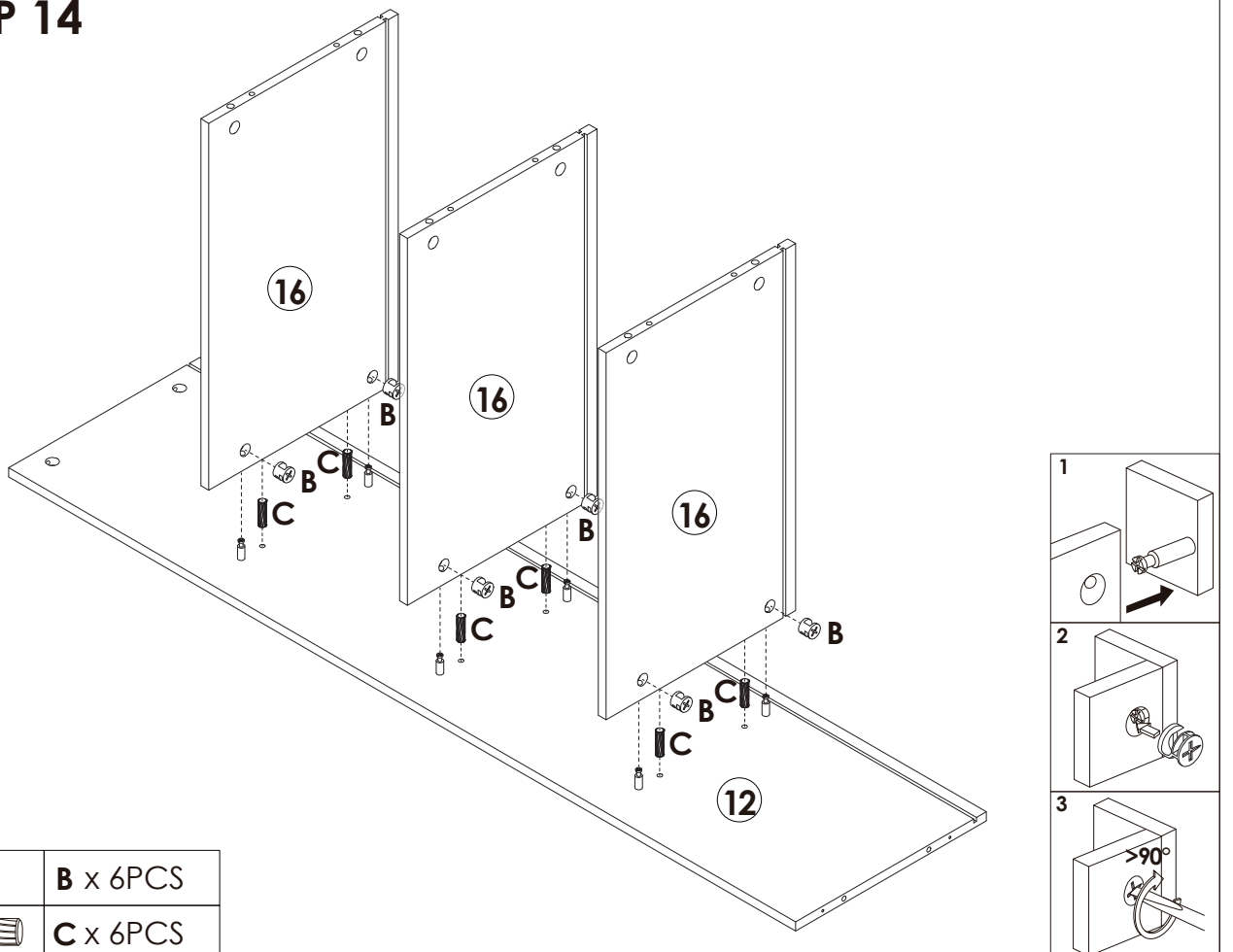

 B x 6PCS

 C x 6PCS

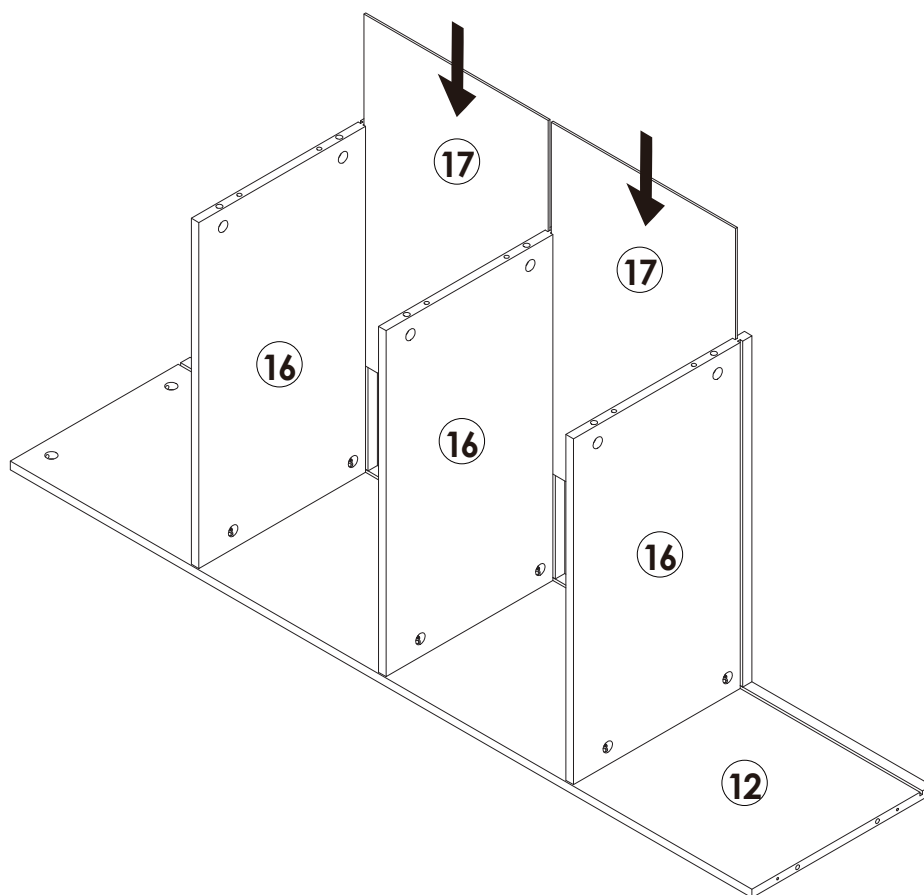

Assembly Steps(EN) / Montageschritte(DE)

STEP 15

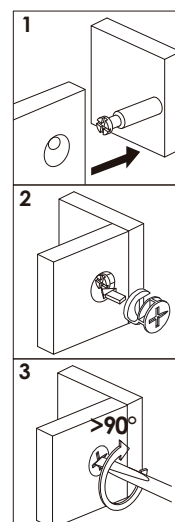
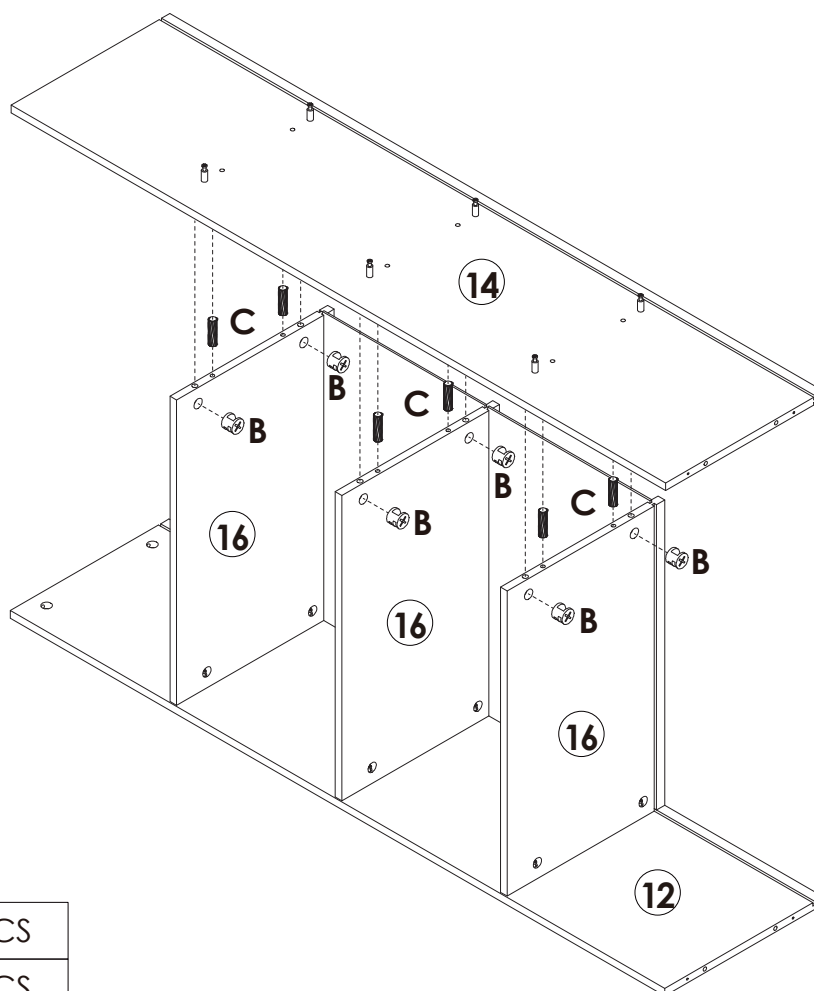

STEP 16





	B x 6PCS
	C x 6PCS

Assembly Steps(EN) / Montageschritte(DE)

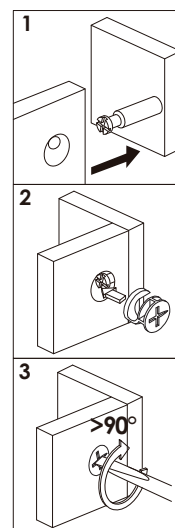
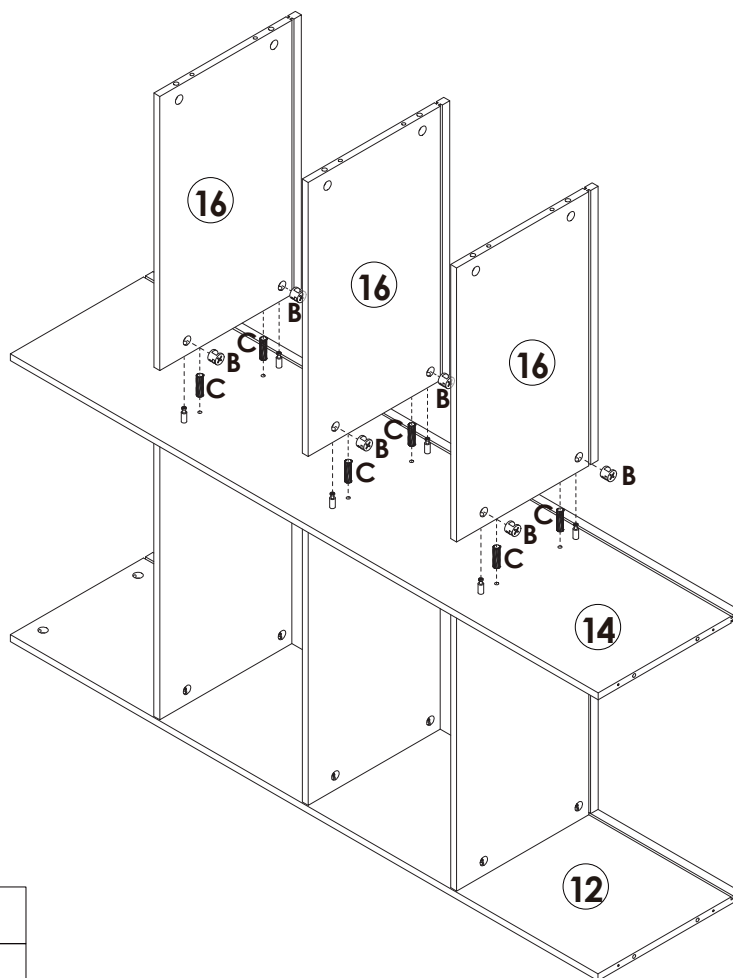
STEP 17



	B x 6PCS
	C x 6PCS

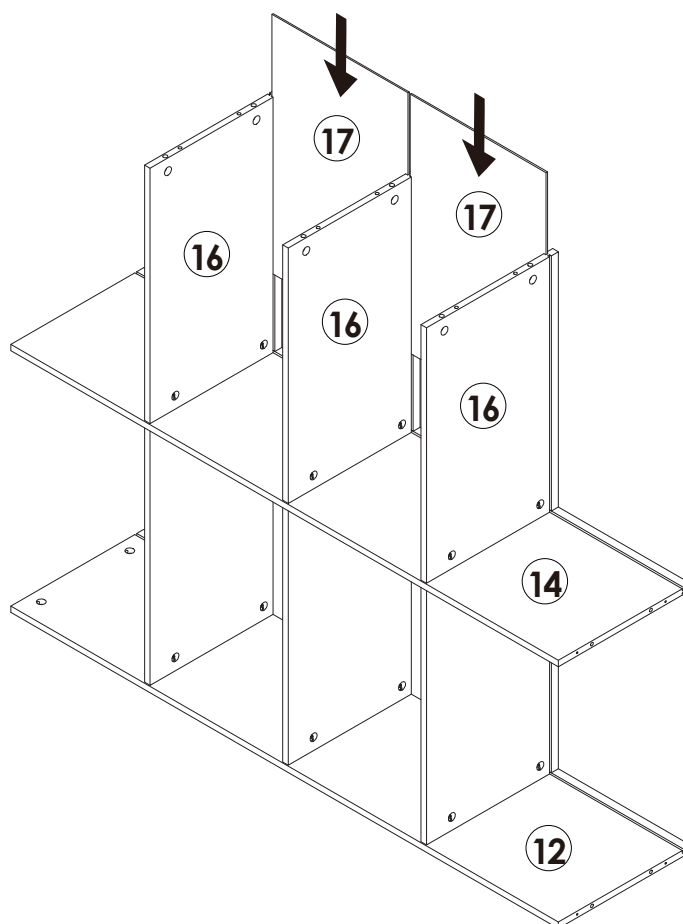

STEP 18



Assembly Steps(EN) / Montageschritte(DE)

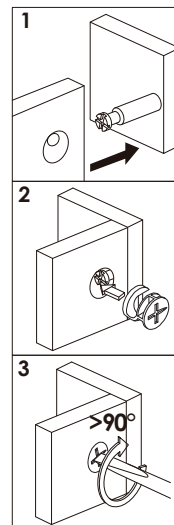
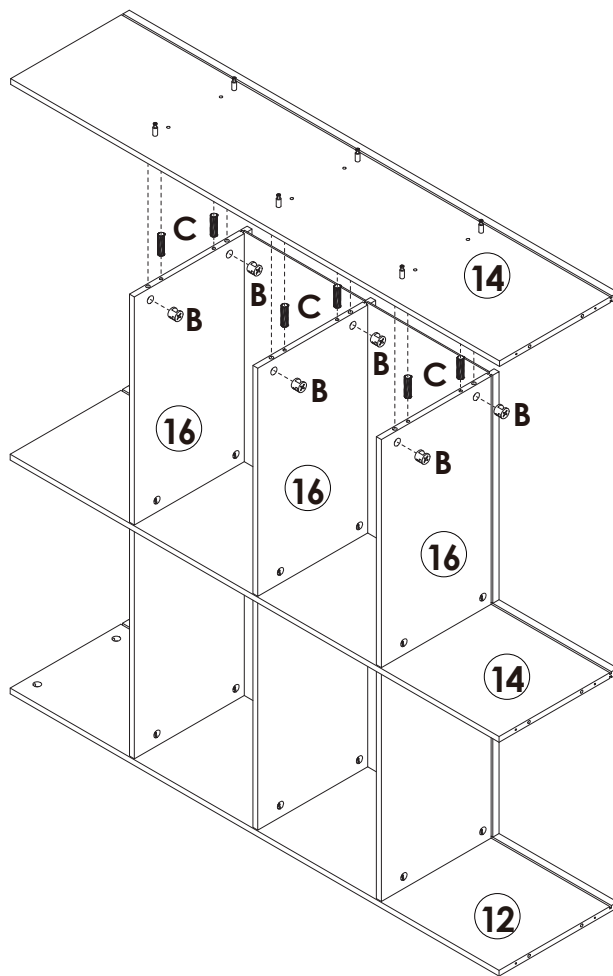

STEP 19

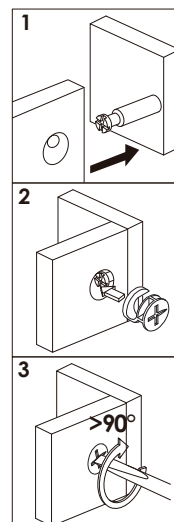
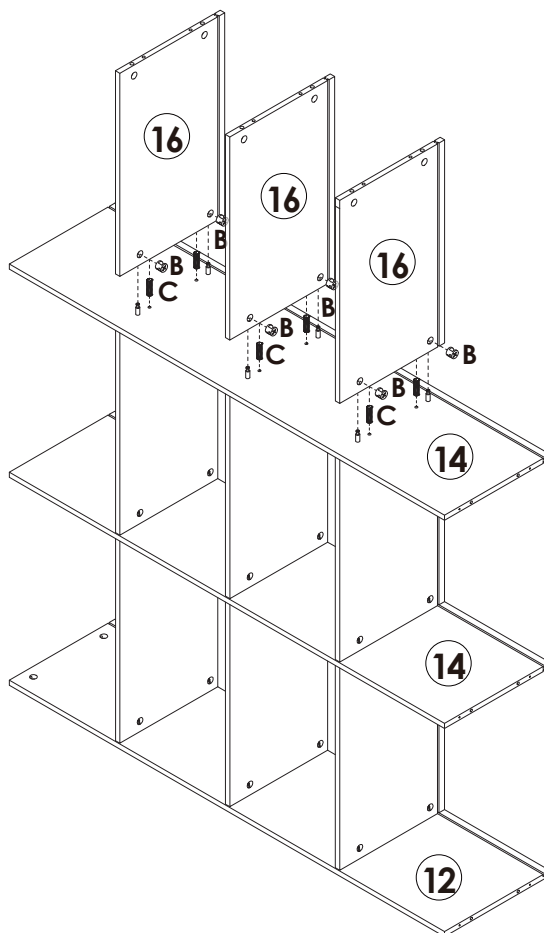

	B x 6PCS
	C x 6PCS

STEP 20



	B x 6PCS
	C x 6PCS

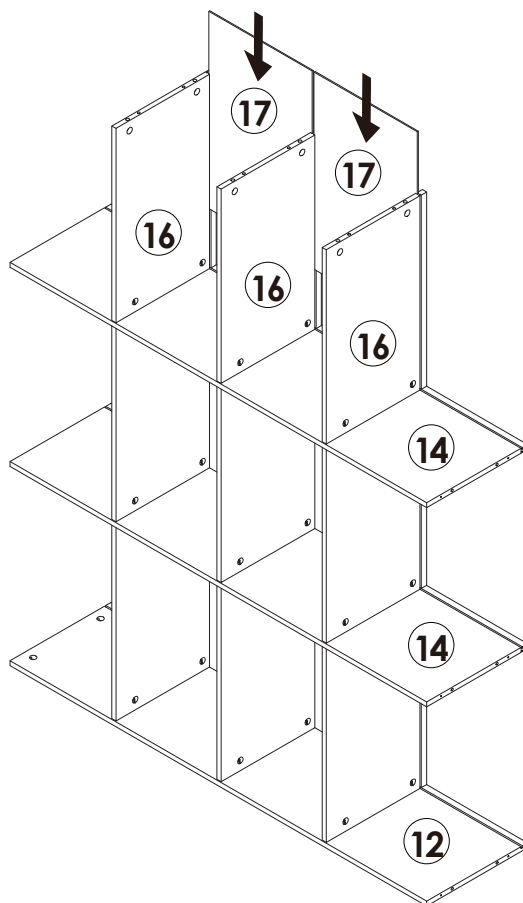

Assembly Steps(EN) / Montageschritte(DE)

STEP 21

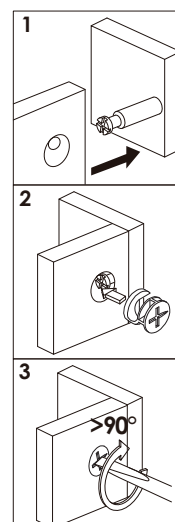
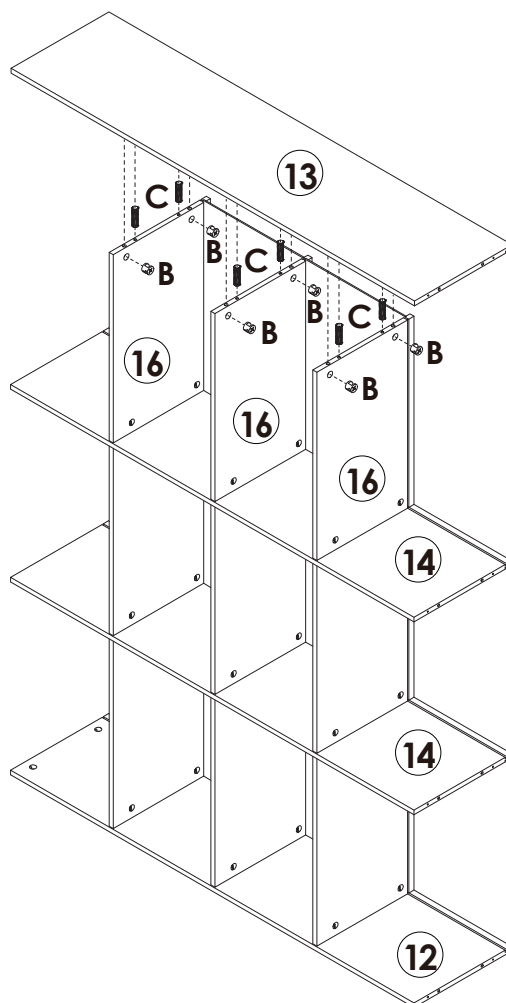

STEP 22



	B x 6PCS
	C x 6PCS

Assembly Steps(EN) / Montageschritte(DE)

STEP 23

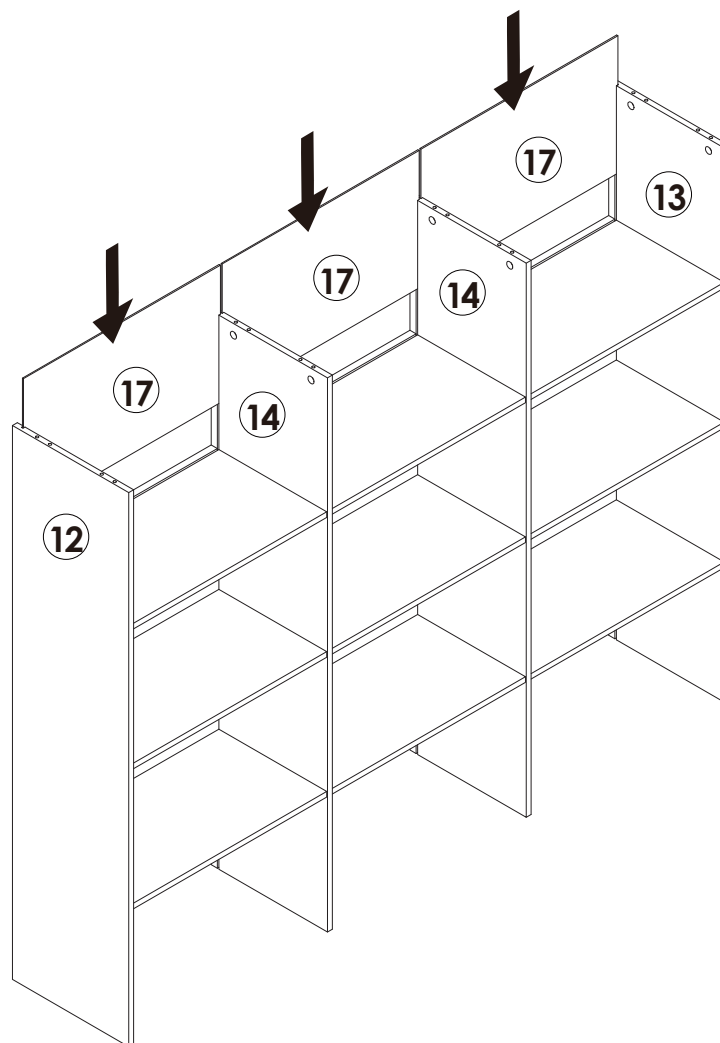

STEP 24

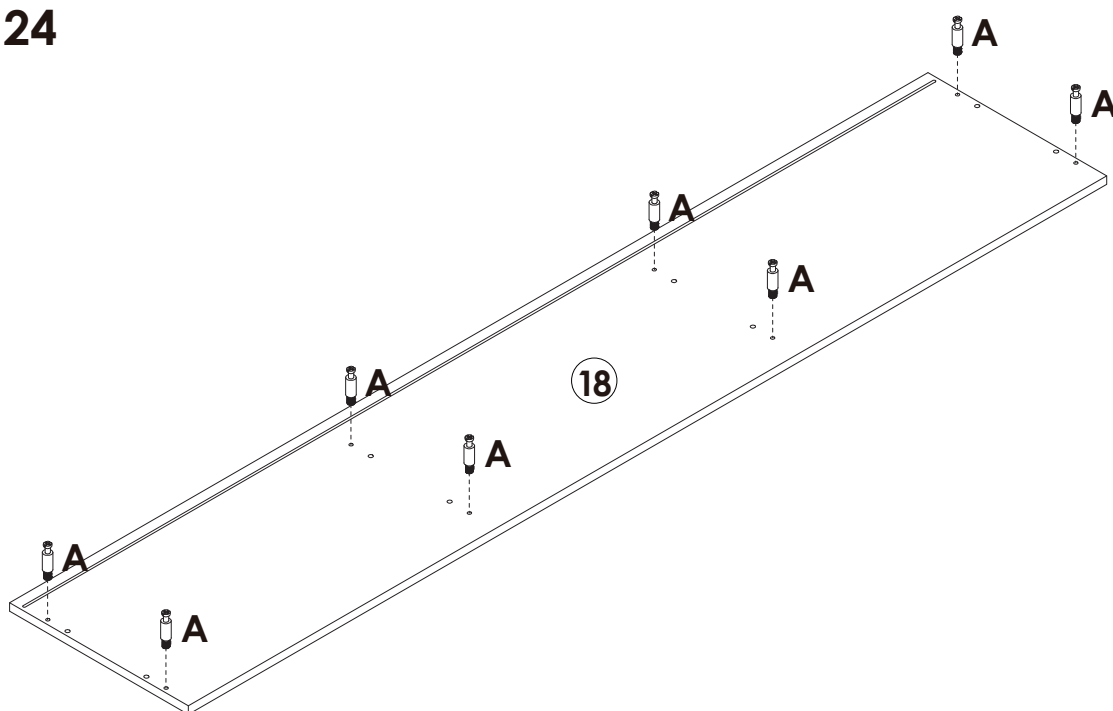



 **A x 8PCS**

Assembly Steps(EN) / Montageschritte(DE)

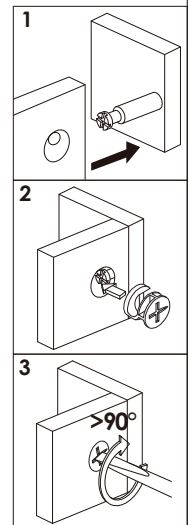
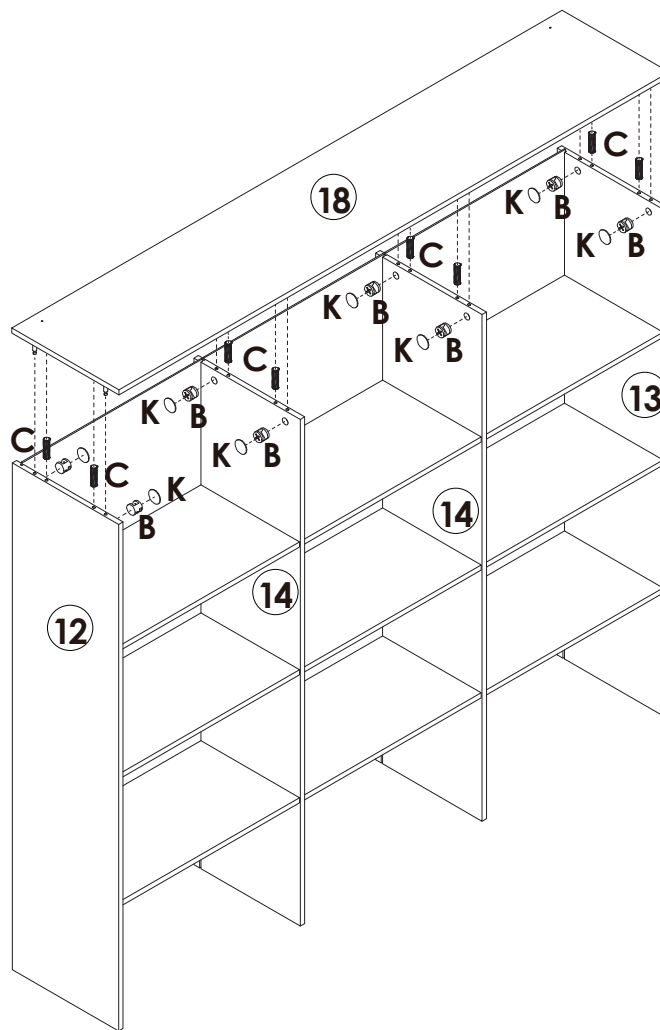
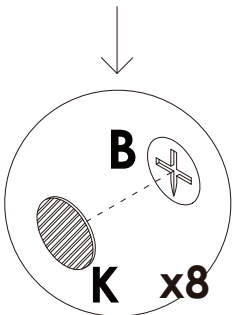
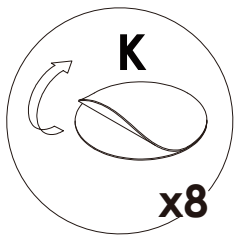
STEP 25



	B x 8PCS
	C x 8PCS
	K x 8PCS

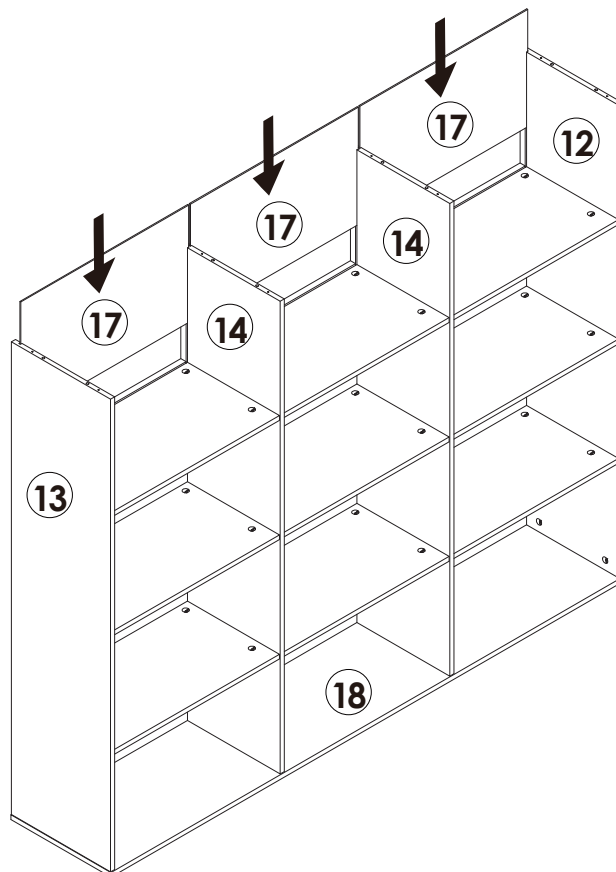

STEP 26



Assembly Steps(EN) / Montageschritte(DE)

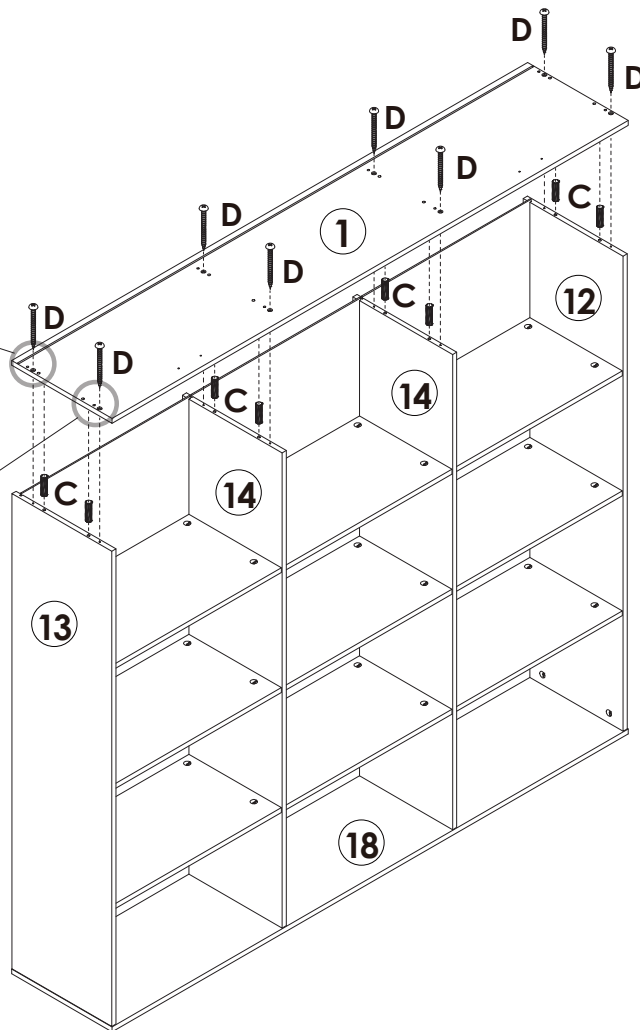
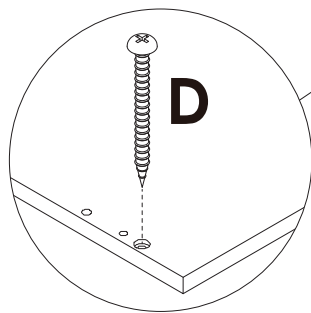
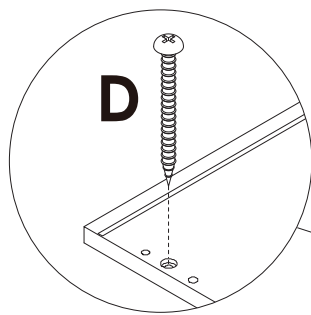

STEP 27

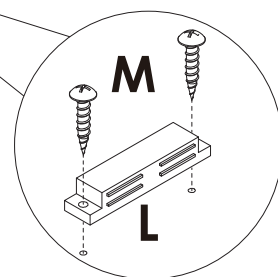
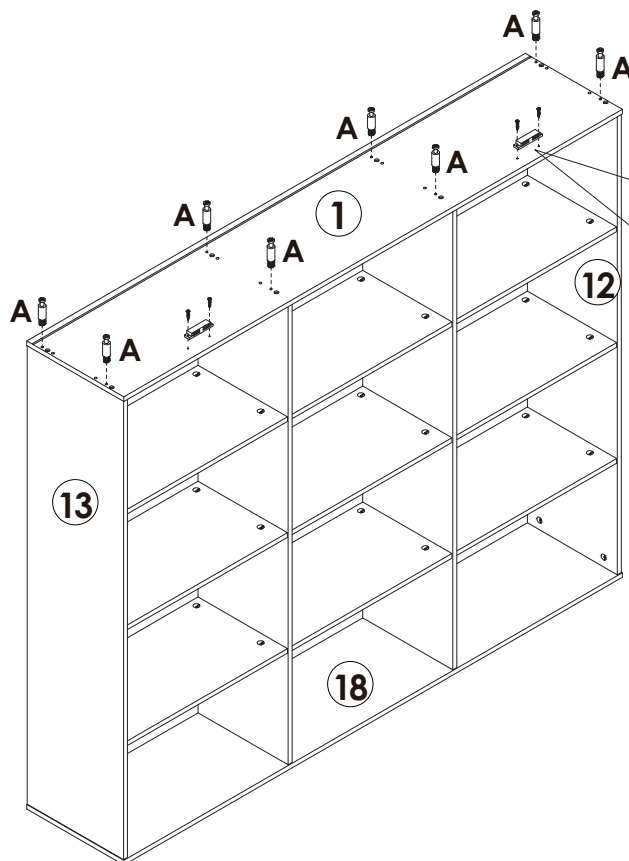

	C x 8PCS
	D x 8PCS

STEP 28

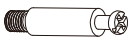



	A x 8PCS
	M x 4PCS
	L x 2PCS

Assembly Steps(EN) / Montageschritte(DE)

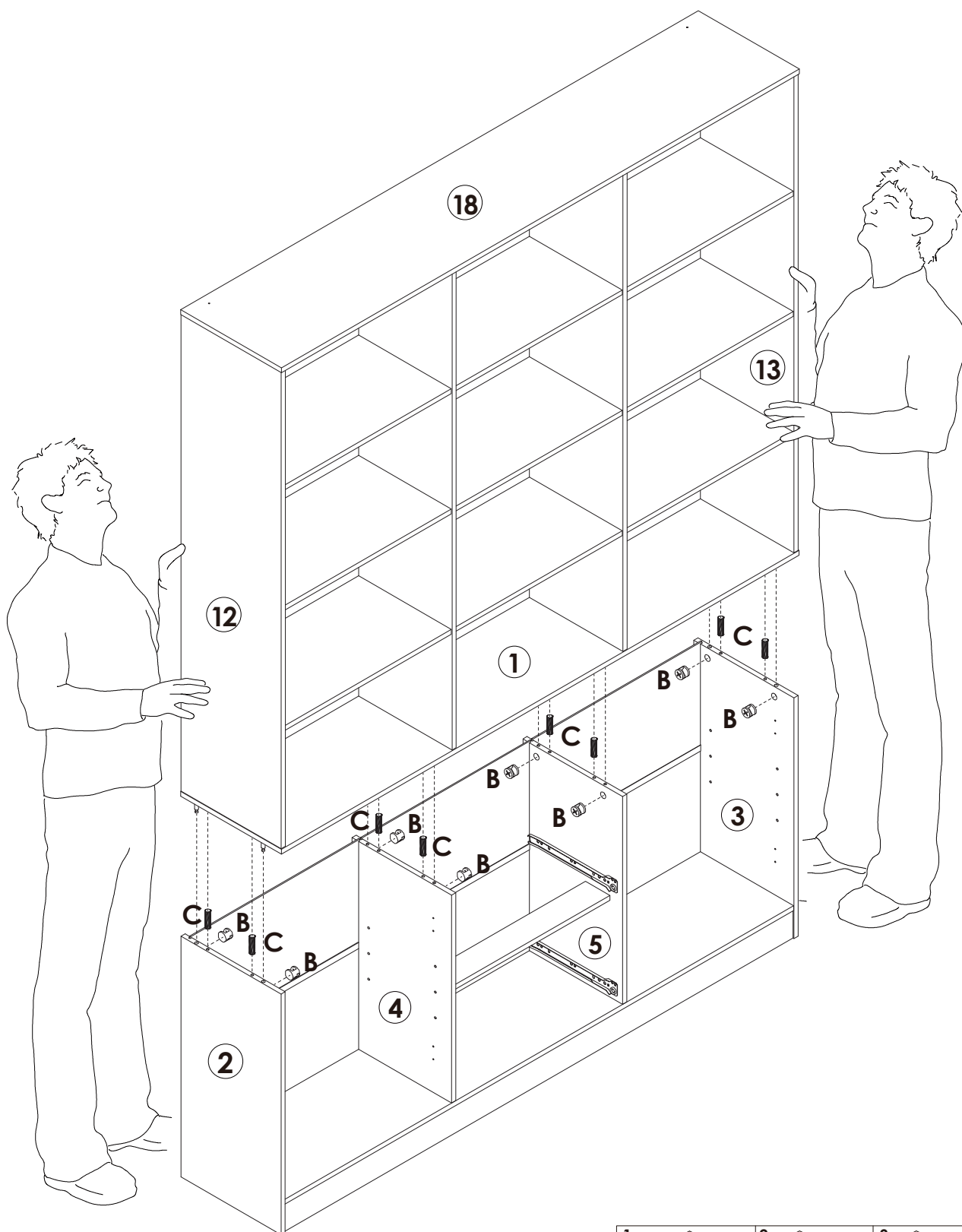
STEP 29



	B x 8PCS
	C x 8PCS

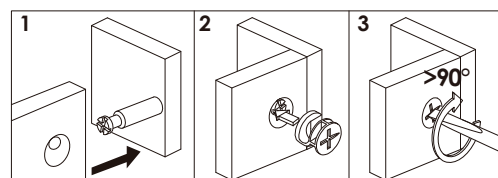



Assembly Steps(EN) / Montageschritte(DE)

STEP 30

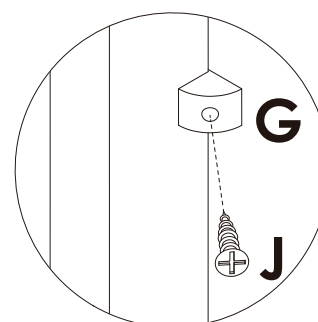
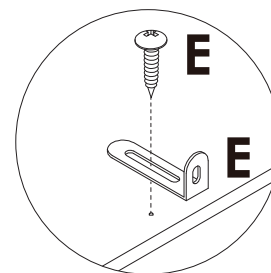
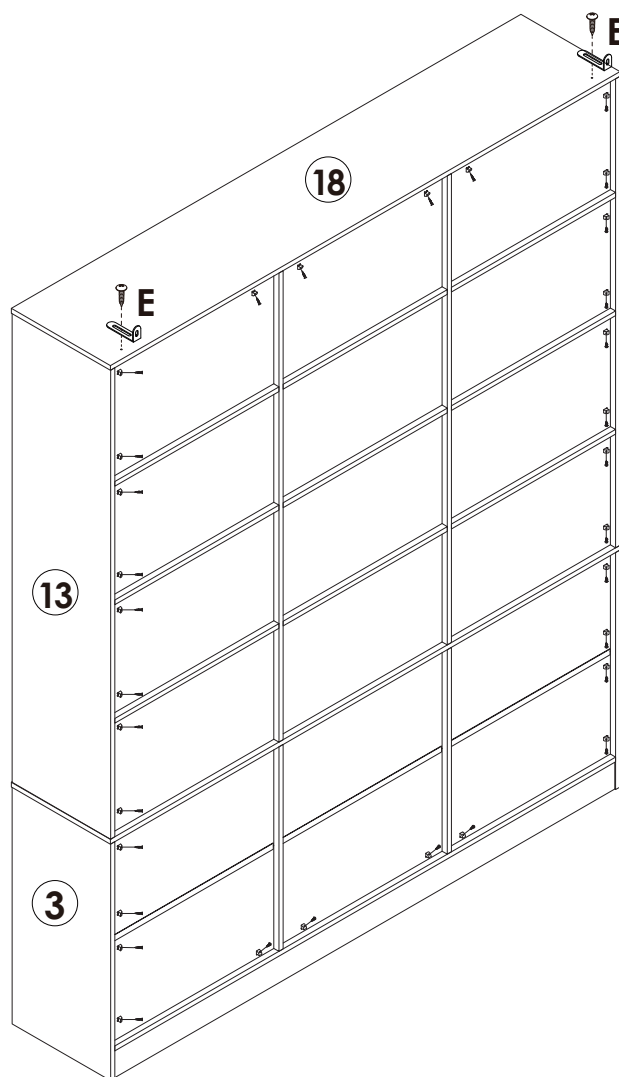
Lock the long side of the "E" L-shaped metal plate to the ⑱ board with the "E" short screw.



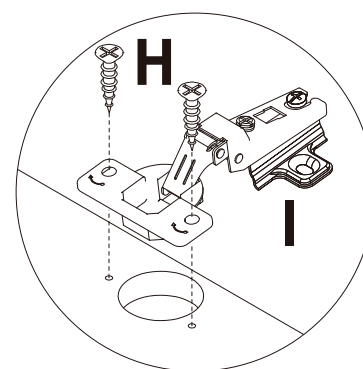
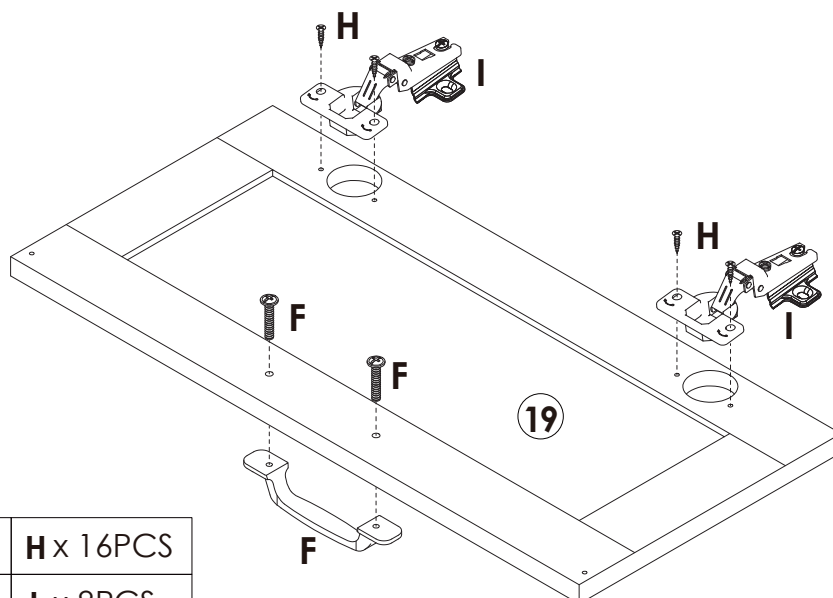

	G x 32PCS
	J x 32PCS
	E x 2SETS

STEP 31



x4

	H x 16PCS
	I x 8PCS
	F x 4SETS

Assembly Steps(EN) / Montageschritte(DE)

STEP 32

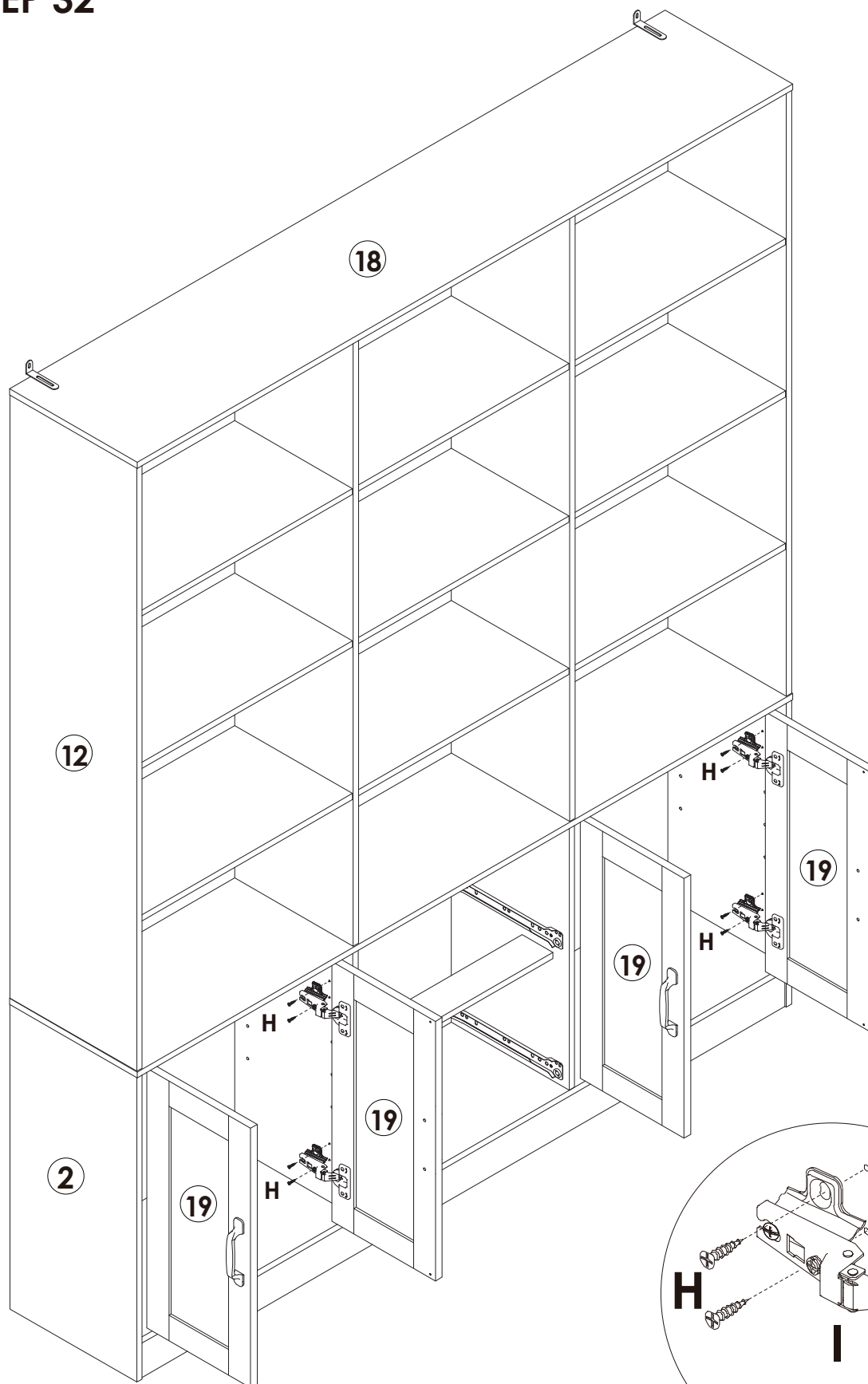



H x 16PCS

Assembly Steps(EN) / Montageschritte(DE)

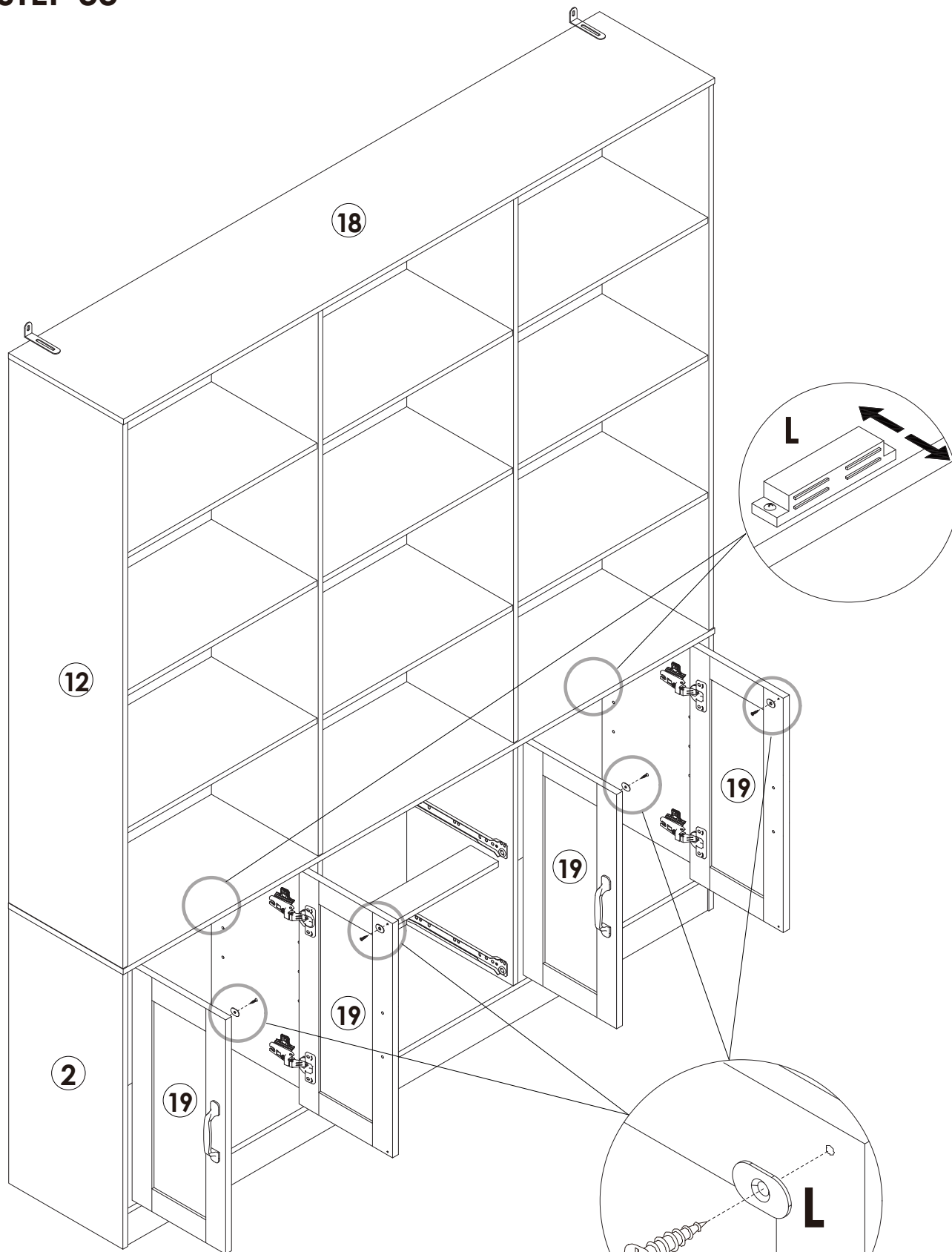
STEP 33



	L x 4PCS
	N x 4PCS

Assembly Steps(EN) / Montageschritte(DE)

STEP 34

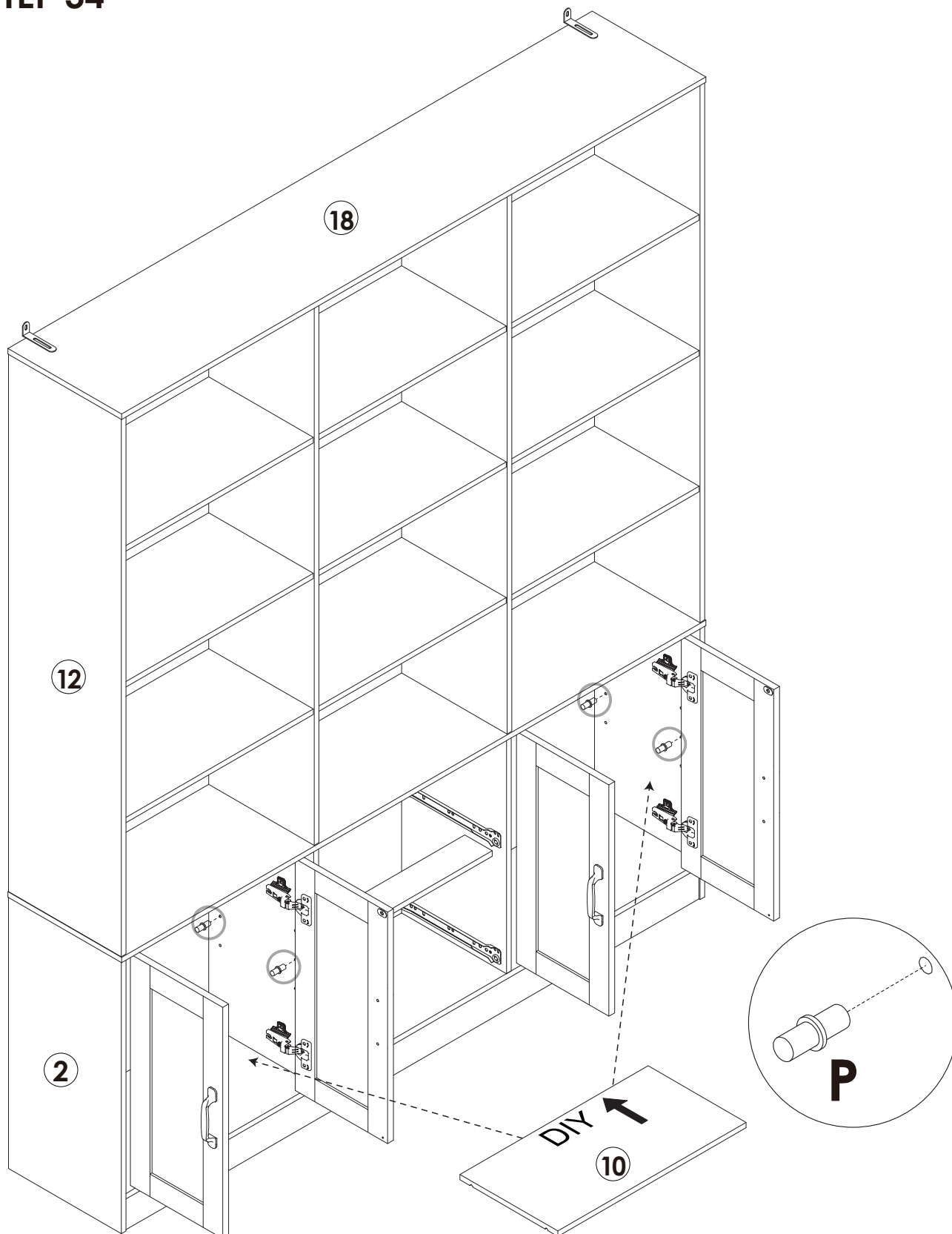

If you want to change the position of ⑩ inside the cabinet, first lift shelf ⑩, remove parts "P", and then take ⑩ out of the door, next insert the parts "P" into the target position, and then put shelf ⑩ back on parts "P".



P x 4PCS

Assembly Steps(EN) / Montageschritte(DE)

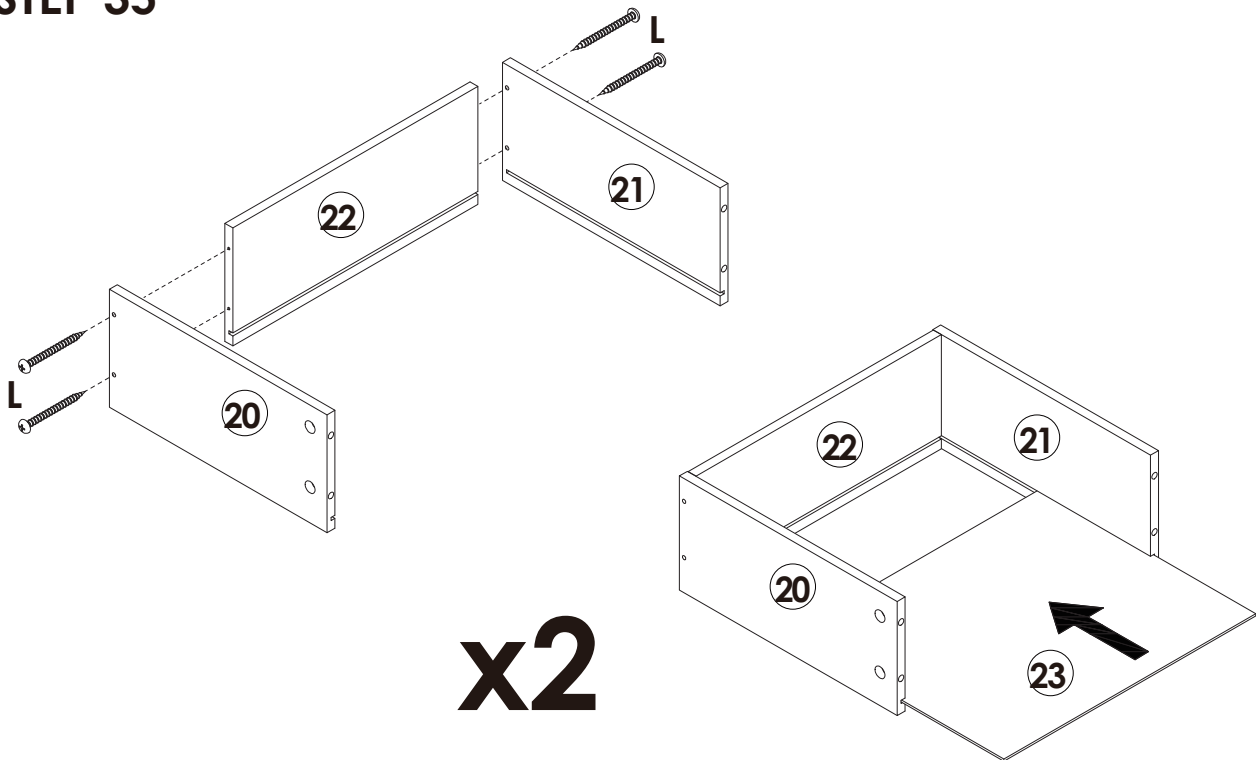

STEP 35

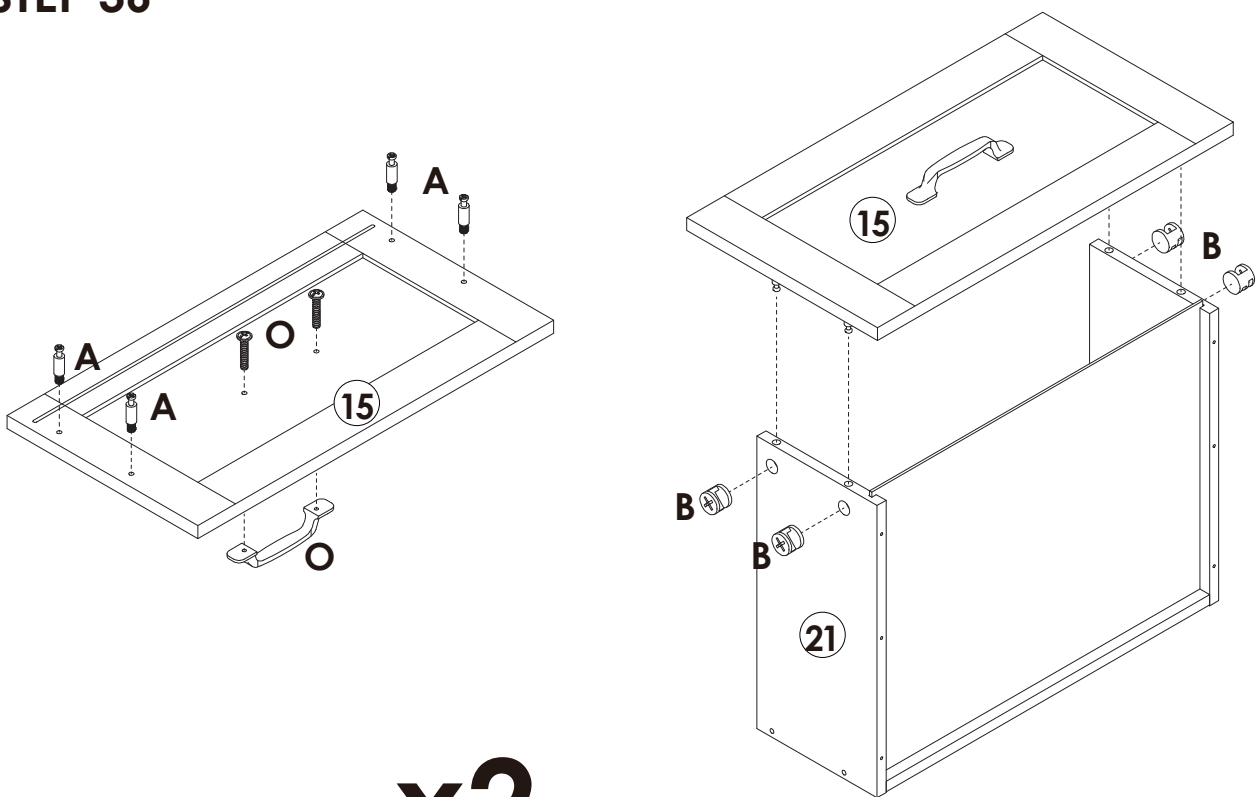

 L x 8PCS

STEP 36

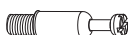



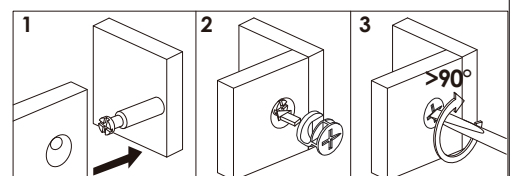

	A x 8PCS
	B x 8PCS
	O x 2SETS

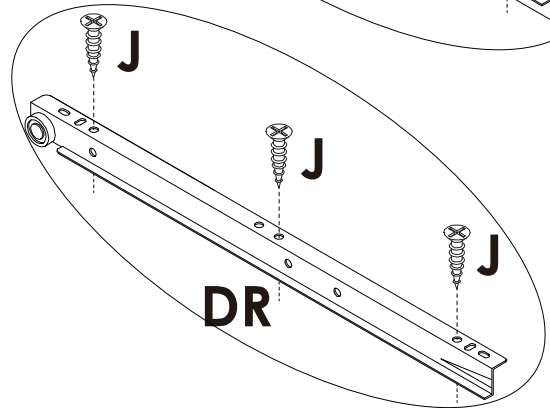
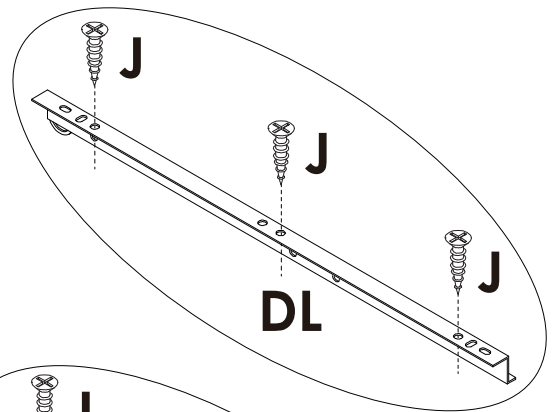
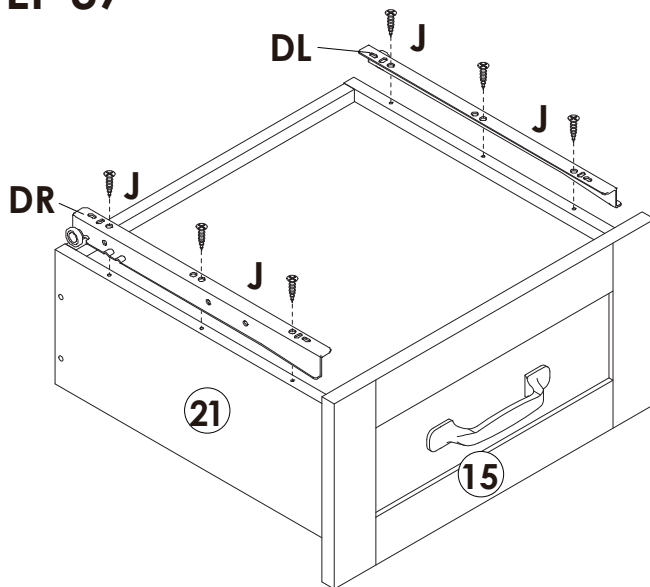

Assembly Steps(EN) / Montageschritte(DE)

STEP 37



	J x 12PCS
	DL x 2PCS
	DR x 2PCS

x2

STEP 38

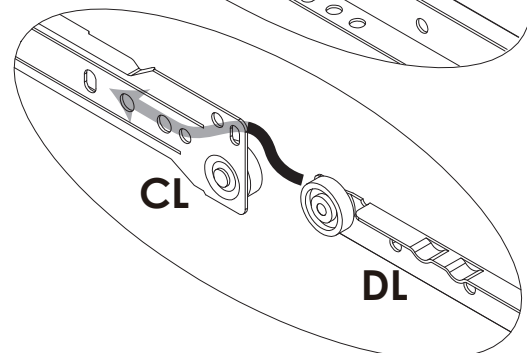
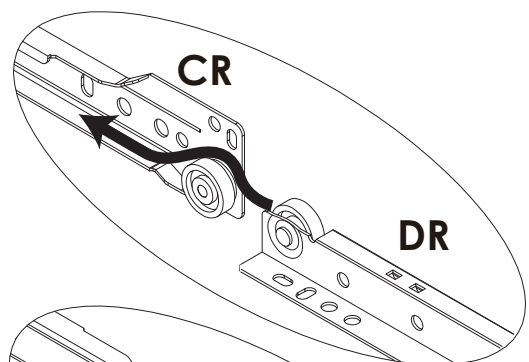
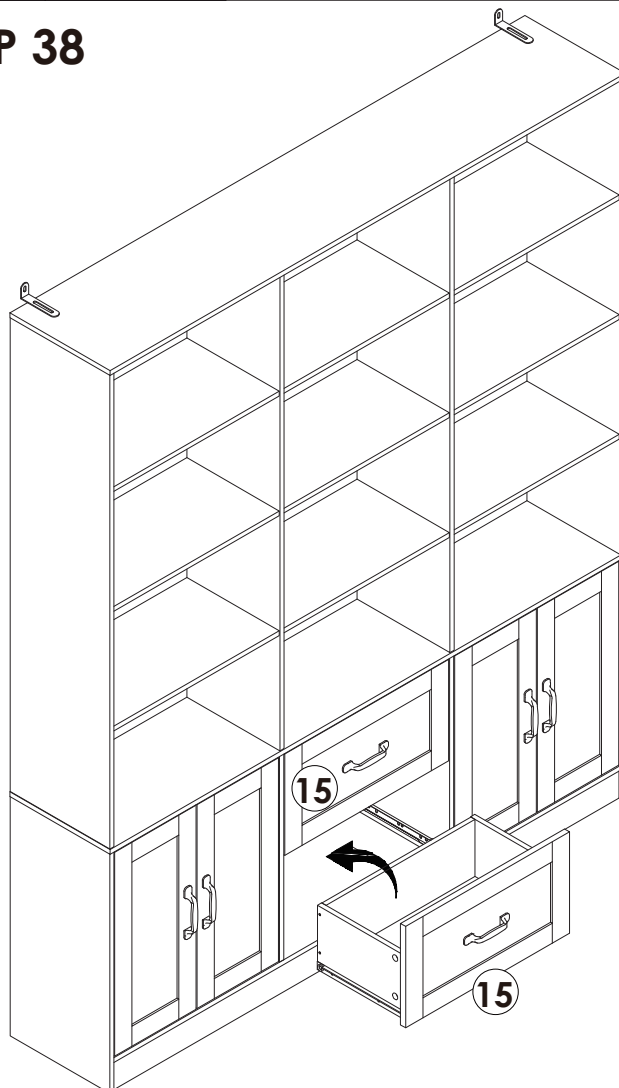

Assembly Steps(EN) / Montageschritte(DE)

STEP 39

WALL

Drill 2 holes on the wall at the required position for anti-falling device installation.

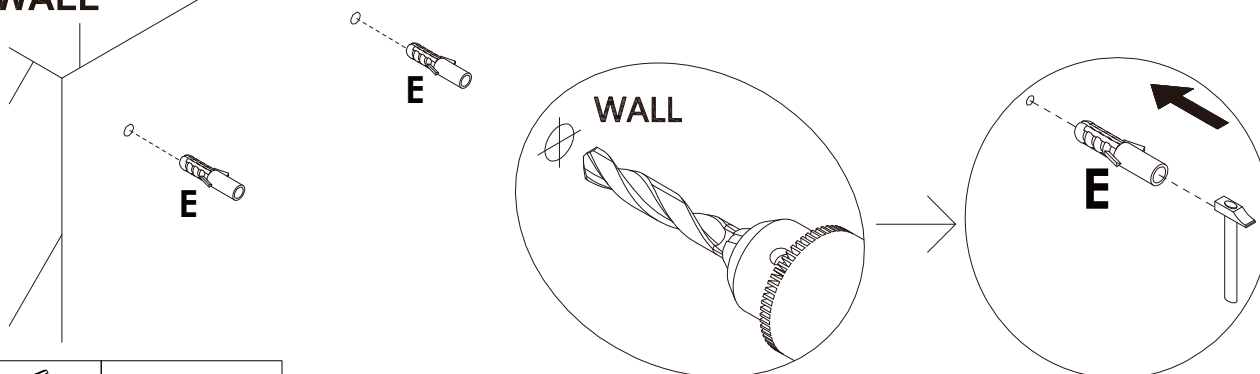

E x 2PCS

STEP 40

Move the cabinet to the required position, use the "D" long screw to fix the cabinet to the wall.

WALL

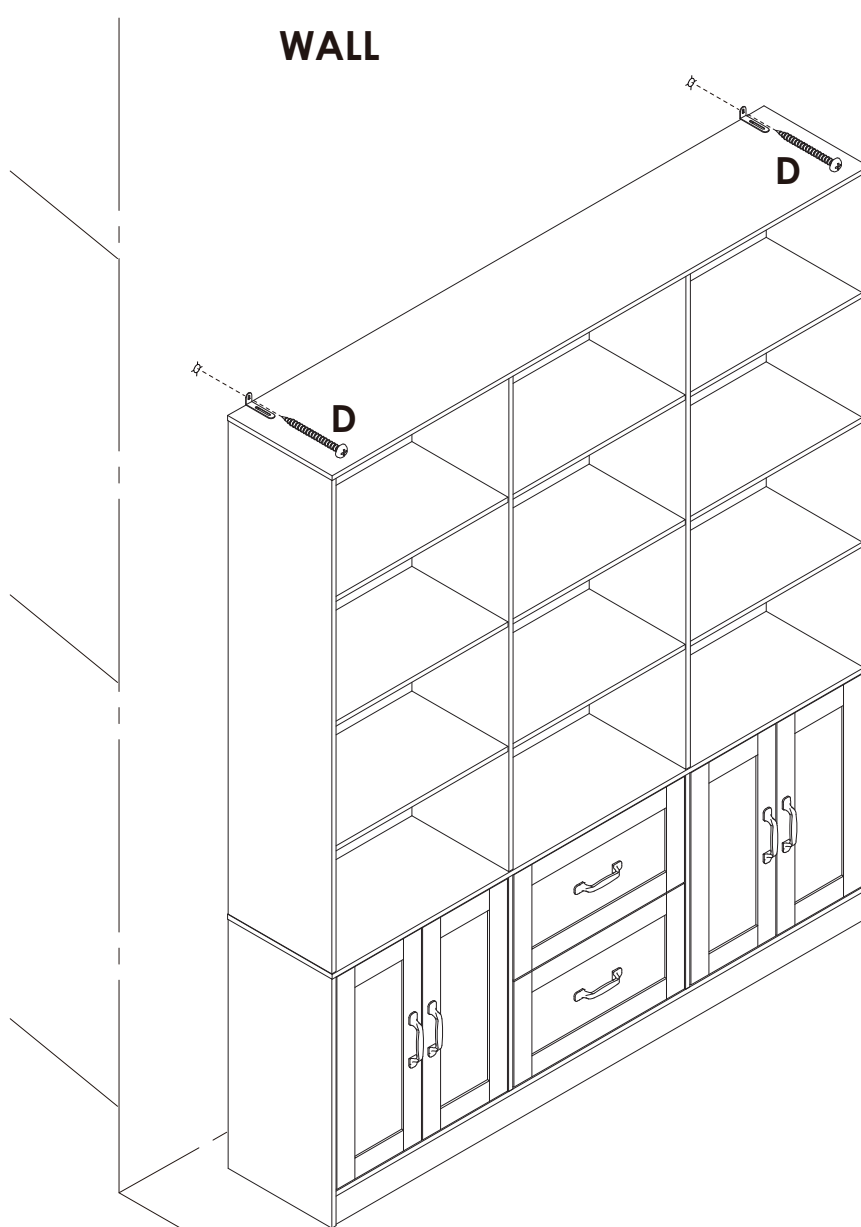

D x 2PCS

The ways to adjust the door

- Before adjusting the hinge, please check whether the cabinet is skewed.
- If the skew can not be repaired, please remove the anti-tipping device first, then adjust the cabinet to vertical position.
- Please adjust the hinge with the door open.
- Please operate it with more than 2 people, one person holds the door and the other one adjusts the screw.

Components Name

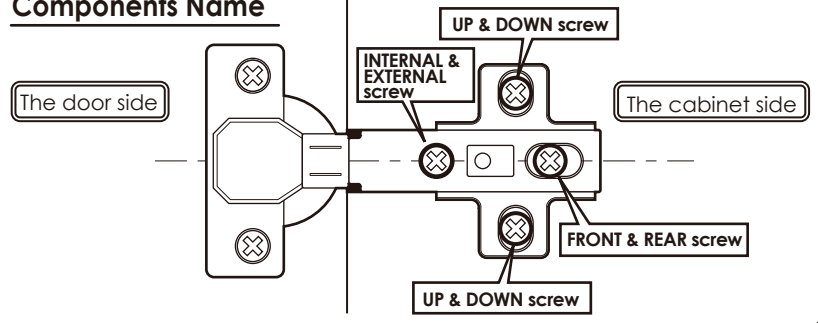

Obvious gaps between doors or Doors don't look closed

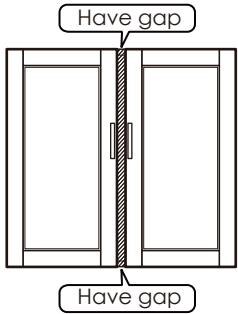

1 Turn "internal & external screw" to the right can make the door approach inside. Please adjust the doors little by little.

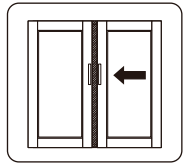
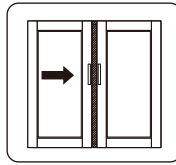
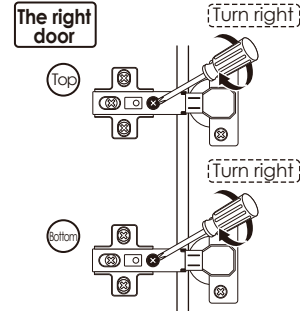
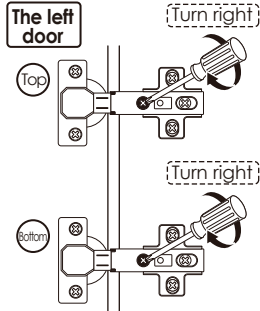

※ If the 2 doors are overlap, please turn the "internal & external screw" to the left.

When door is crooked



Please take the following steps to adjust first.

1 Rotate the "front and rear screws" to the left

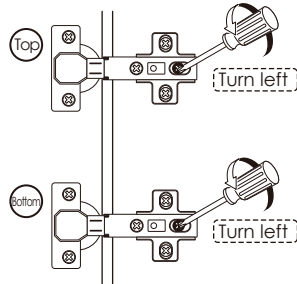

※ After adjusting the "front and rear screw", the door still does not change, please turn the "internal & external screw" to the right slightly.

2 Push the door to the cabinet

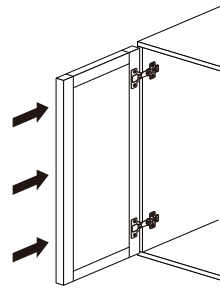

3 Rotate the "front and rear screws" to the right

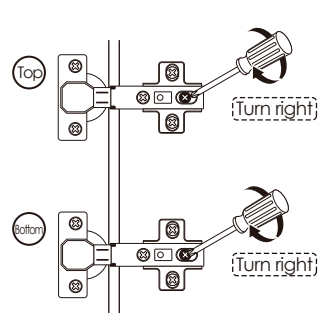

When door is leaning

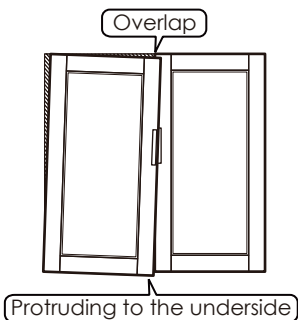

1 Turn "internal & external screw" to the left can make the top of the door tilted outward.

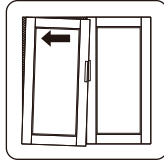
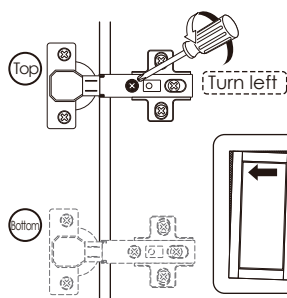

Protruding to the upside

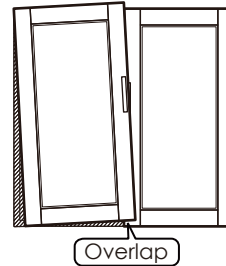

1 Turn "internal & external screw" to the left can make the bottom of the door tilted outward.

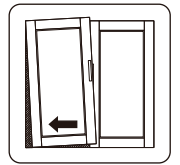
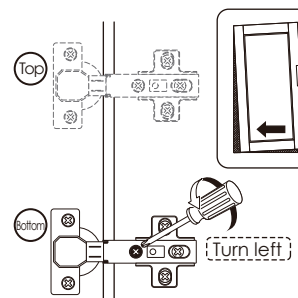

When the door is higher on top

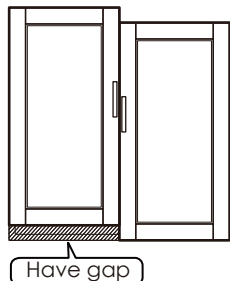

1 Turn "up & down screw" to the left

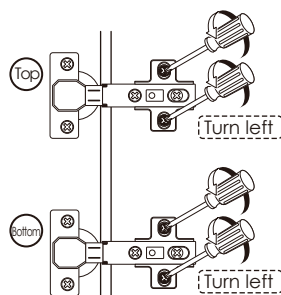

2 Lower the door's height so that 2 doors are of the same height.

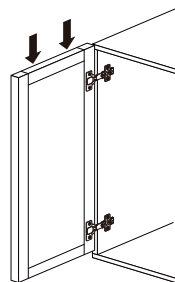

3 Turn "up & down screw" to the right

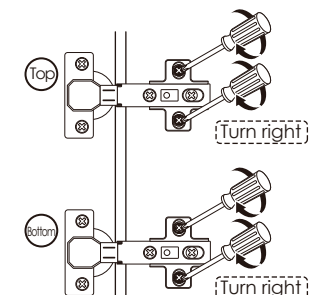

※ If the door is lower on bottom, please lift up the left door slightly on step 2



WARNING



Children have died from furniture tipover. To reduce the risk of furniture tipover:

- **ALWAYS** install Anti-tip device provided.
- **NEVER** put a TV on this product.
- **NEVER** allow children to stand, climb or hang on any drawers, doors, or shelves.
- **NEVER** open more than one drawer at a time.
- Place heaviest items in the lowest drawers.



***This is a permanent label.
Do not remove!***