

ASSEMBLY INSTRUCTIONS

FULL/QUEEN BUNKBED

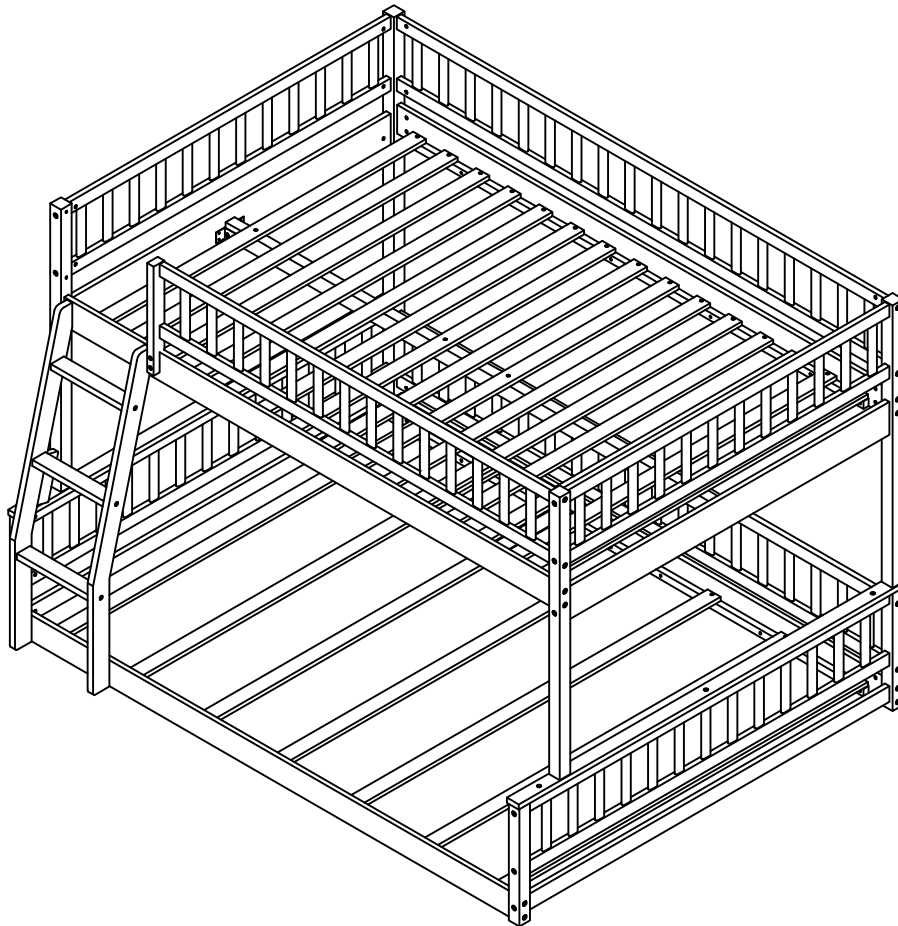

SAFETY WARNINGS AND GENERAL NOTES:

Follow the information on the warnings on the bunk bed end structure and on the carton. Do not remove the warning label from the bed. Always use the recommended size mattress on mattress support, or both, to help prevent the likelihood of entrapment or falls.

The top surface of the mattress must be at least 5*inch (127mm) below the upper edge of the guardrail.

Do not allow children under 6 years of age to use the upper bunk.

Periodically check and ensure the guardrail, ladder and other components are in their proper position, free from damage, and all connectors are tight.

Do not allow horseplay on or under beds.

Always prohibit jumping on the bed.

Prohibit more than one person on upper bunk.

Always use the ladder for entering and leaving the upper bunk.

Do not use substitute parts. Contact the manufacturer or dealer for replacement parts.

Use of a night-light may provide added safety precaution for a child using the upper bunk.

Always use guardrails on both long sides of the upper bunk.

If the bunk bed will be placed next to a wall, the guardrail that runs the full length of the bed should be placed against the wall to prevent entrapment between the bed and the wall.

The use of water or sleep flotation mattresses is prohibited.

STRANGULATION HAZARD-Never attach or hang items to any part of the bunk bed that are not designed for use with the bed.

Keep these instructions for future reference.

We recommend assembling your bunk bed on the shipping carton to protect your floor or carpet.

Be certain all staples are out of the box before beginning assembly on the shipping carton.





THIS BED IS DESIGNED TO USE A FULL XL MATTRESSES 54" WIDE X 79"-80" LONG WITH THE TOTAL THICKNESS NOT EXCEEDING 6" FOR UPPER BUNK, FOR THE LOWER QUEEN-SIZE SHOULD BE 60" WIDE X 80" LONG, WIDE WITH 8" THICKNESS.

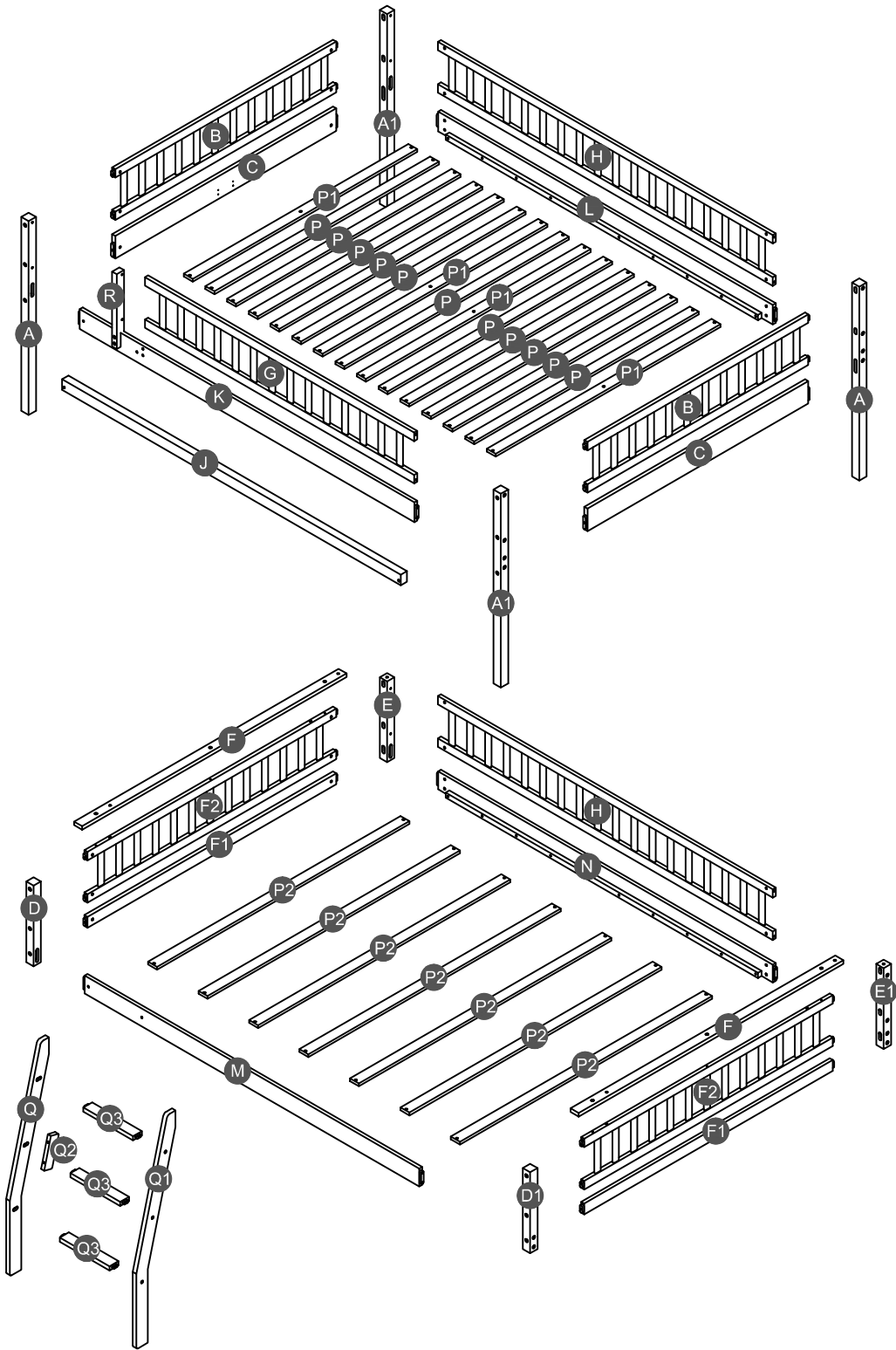



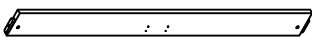
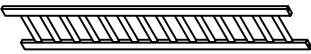
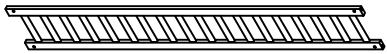
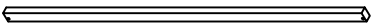

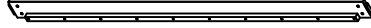
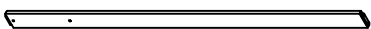

SURFACE OF MATTRESS MUST BE AT LEAST 5" (127MM) BELOW THE UPPER EDGE OF GUARDRAILS.

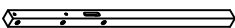
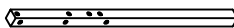
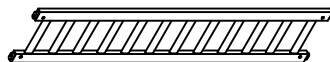
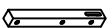
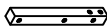
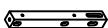

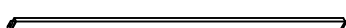
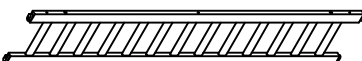

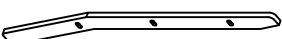
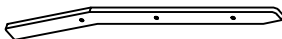



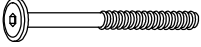

Detail View



Part List

C  Upper horizontal bar HB/FB - 2pcs	G  Short guard rail (Front) - 1pc	H  Long guard rail (Back) - 2pcs
J  Lower support slat - 1pc	K  Upper side rail (Front) - 1pc	L  Upper side rail (Back) - 1pc
M  Lower side rail (Front) - 1pc	N  Lower side rail (Back) - 1pc	P2  Lower Slat - 7pcs

A  Upper Leg (Left front /Right back) - 2pcs	A1  Upper Leg (Left back /Right front) - 2pcs	B  Upper Frame HB/FB - 2pcs
D  Lower Leg (Left front) - 1pc	D1  Lower Leg (Right front) - 1pc	E  Lower Leg (Left back) - 1pc
E1  Lower Leg (Right back) - 1pc	F  Cap for upper HB/FB - 2pcs	F1  Lower horizontal bar HB/FB - 2pcs
F2  Lower Frame HB/FB - 2pcs	P  Upper Slat - 11pcs	P1  Upper Slat - 4pcs
Q  Left side ladder - 1pc	Q1  Right side ladder - 1pc	Q2  Support ladder - 1pc
Q3  Step ladder - 3pcs	R  Vertical guard rail - 1pc	

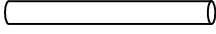
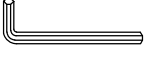

1  (Ø15)1/4"*100mm Hex-Head bolts (26pcs)	2  (Ø15)1/4"*80mm Hex-Head bolts (26pcs)	3  (Ø12)1/4"*60mm Hex-Head bolts (8pcs)
4  (Ø12)1/4"*40mm Hex-Head bolts (6pcs)	5  (Ø12)1/4"*35mm Hex-Head bolts (2pcs)	6  1/4"*15 (9.5mm) Horizontal-Hole bolts(58pcs)
7  (Ø12)1/4"*40mm Hex-Head bolts (6pcs)	8  Ø4*30mm Wood screws (48pcs)	9  Ø3.5*15mm Wood screws (8pcs)
10  (Ø13)1/4"*14mm Connect bolt (2pcs)	11  116*40*27mm Metal bracket (2pcs)	12  Ø9*90mm Connecting bar (4pcs)
13  (1/4")4.5*58mm Allen key (2pcs)		

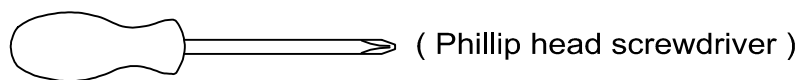
ASSEMBLY TOOLS REQUIRED (NOT INCLUDED)



DO NOT USE POWER TOOLS TO ASSEMBLE THIS PRODUCT !

STEP 1:

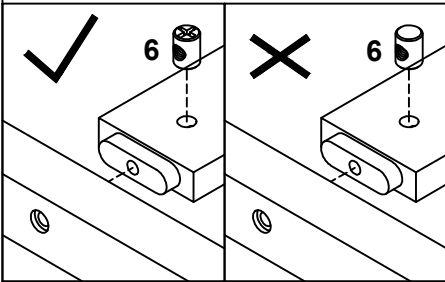
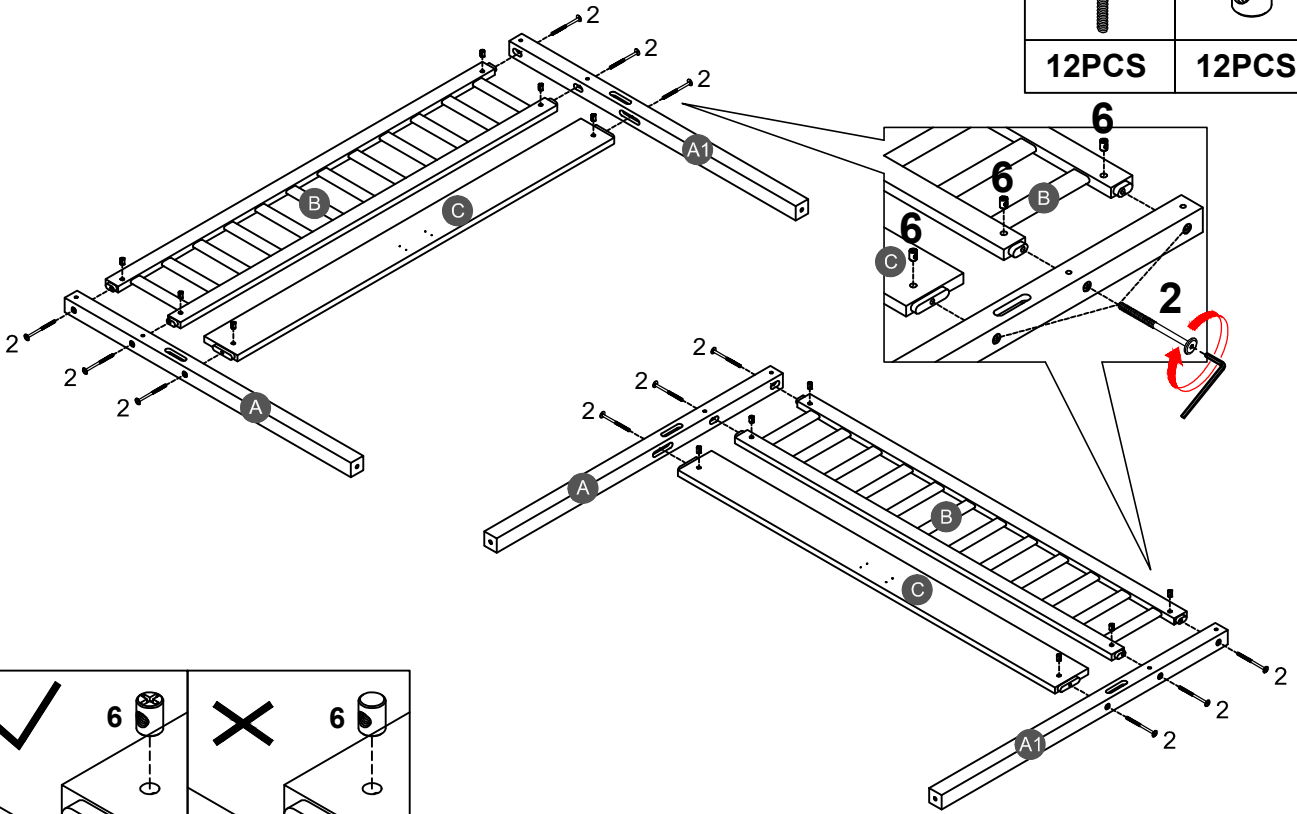

2		6	
12PCS		12PCS	



Note: Part 6 will face up with the "x" mark on it, otherwise it cannot be tightened

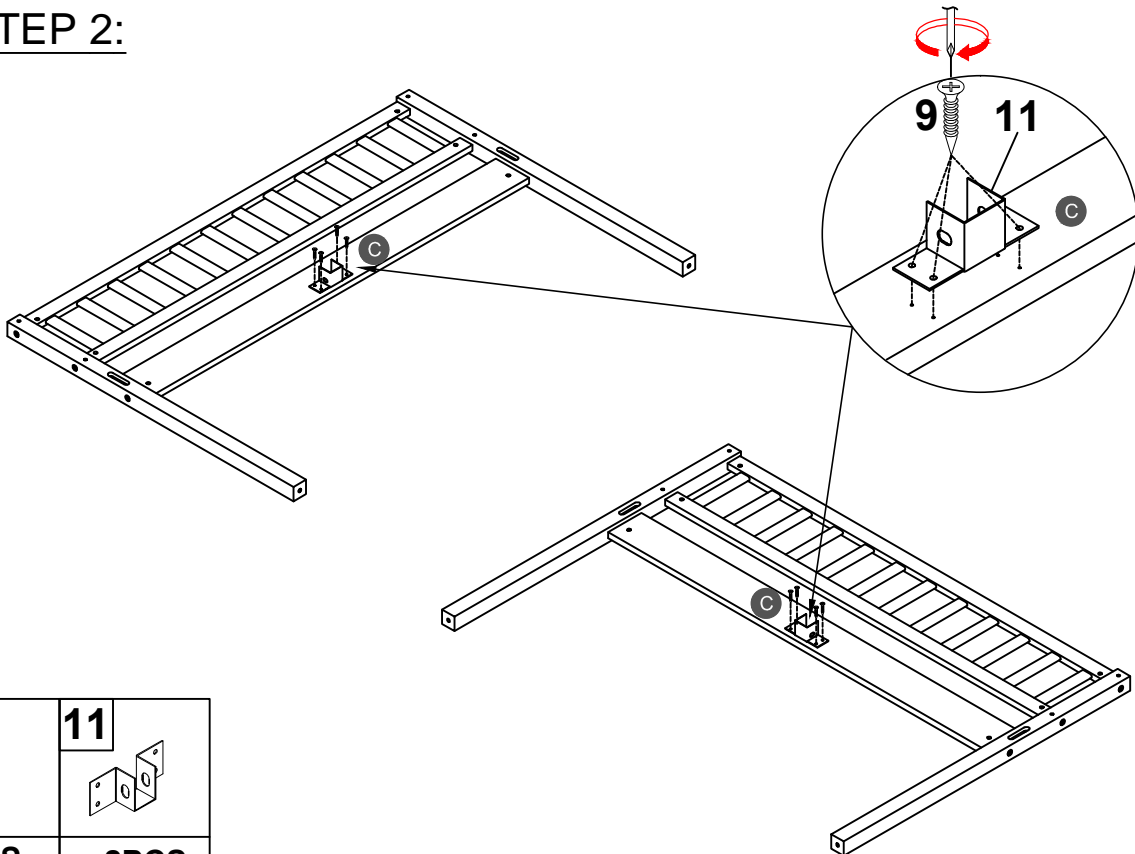

STEP 2:



9		11	
8PCS		2PCS	

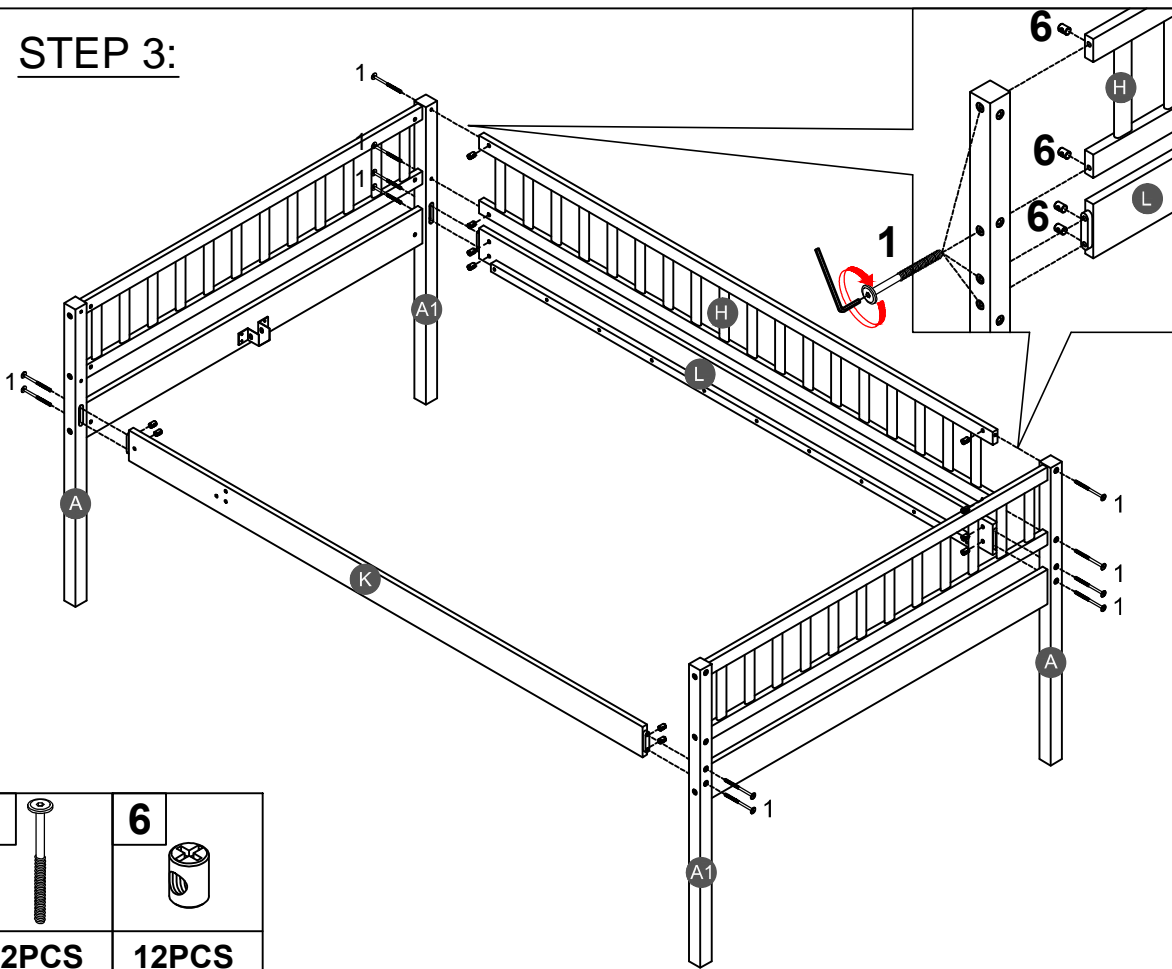



STEP 3:



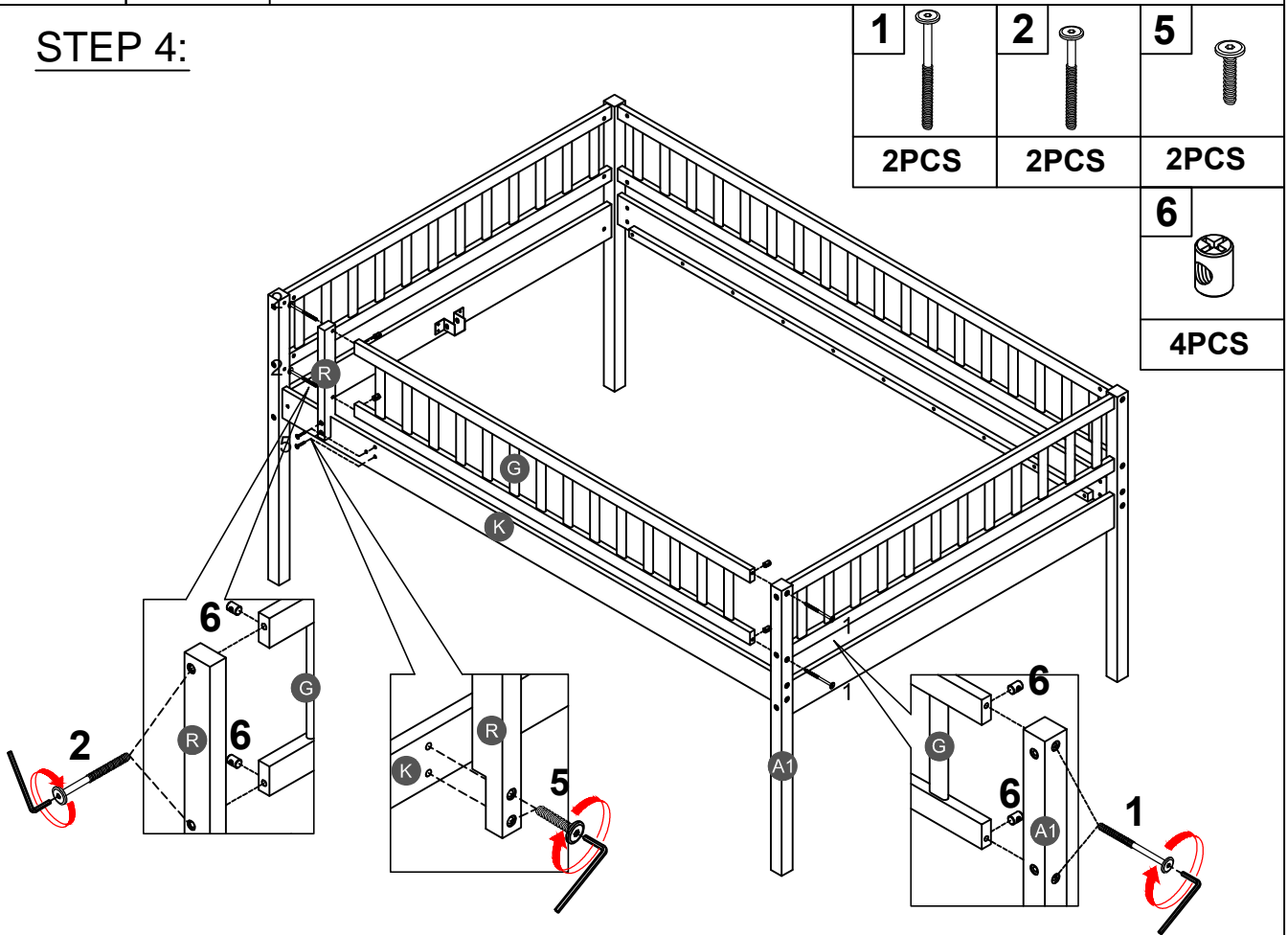

1		6	
12PCS		12PCS	

STEP 4:



1		2		5	
2PCS		2PCS		2PCS	
				6	
				4PCS	

STEP 5:

4		10	
2PCS		2PCS	

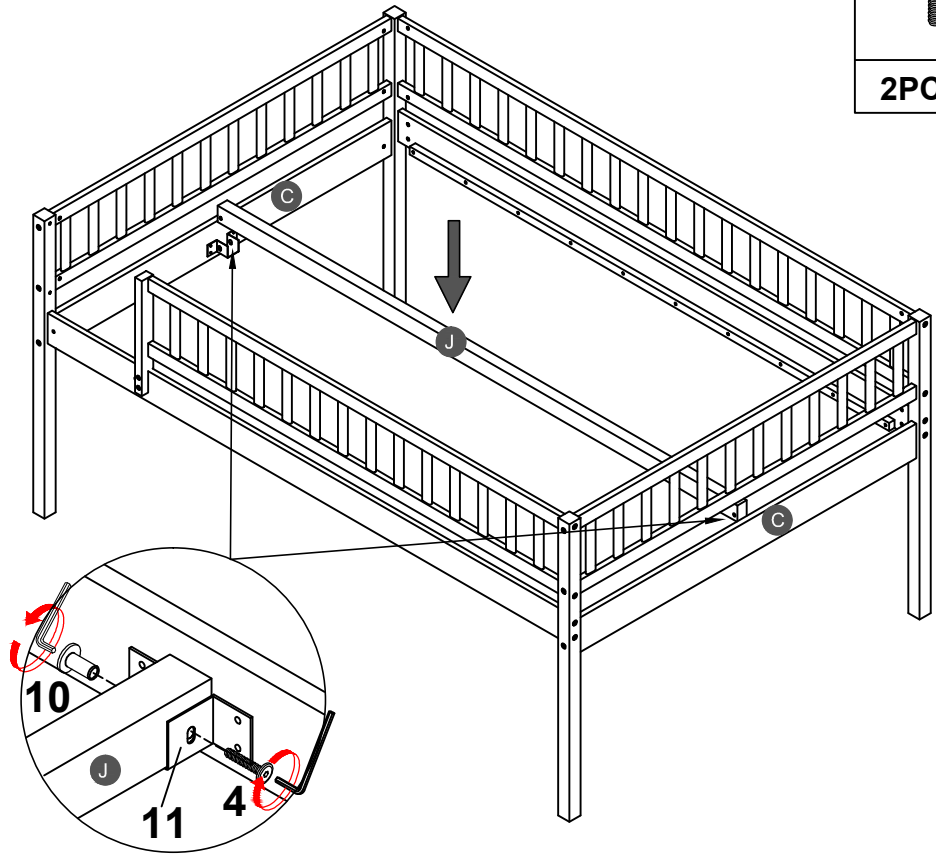

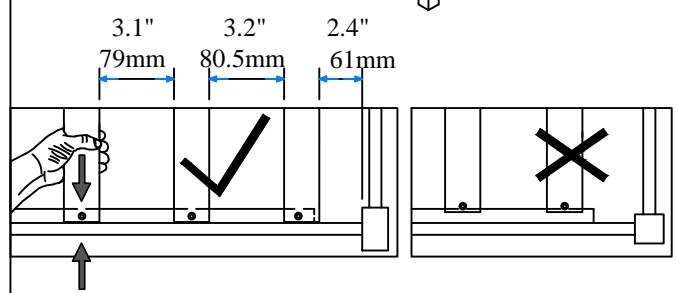
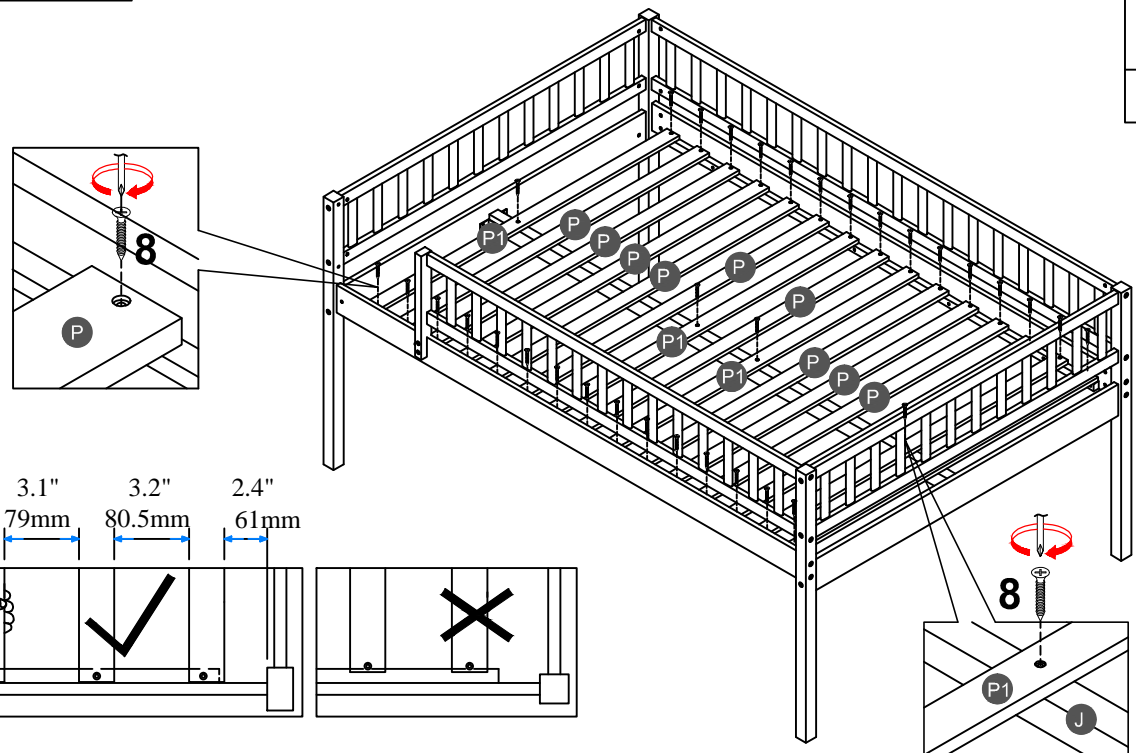

STEP 6:

8	
34PCS	



NOTE: Please make sure the bed slats close to the side rail before locking the screws to avoid breakage. This step is required for both the left and right sides. Moreover, please do not lock the screws of the bed slats at the outermost edge to avoid damaging.

STEP 7:

2		6	
12PCS		12PCS	

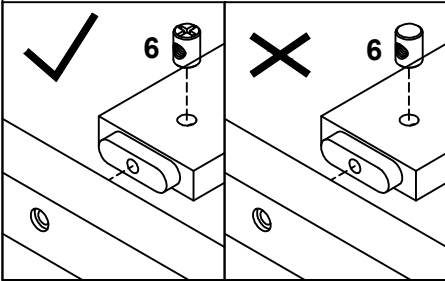
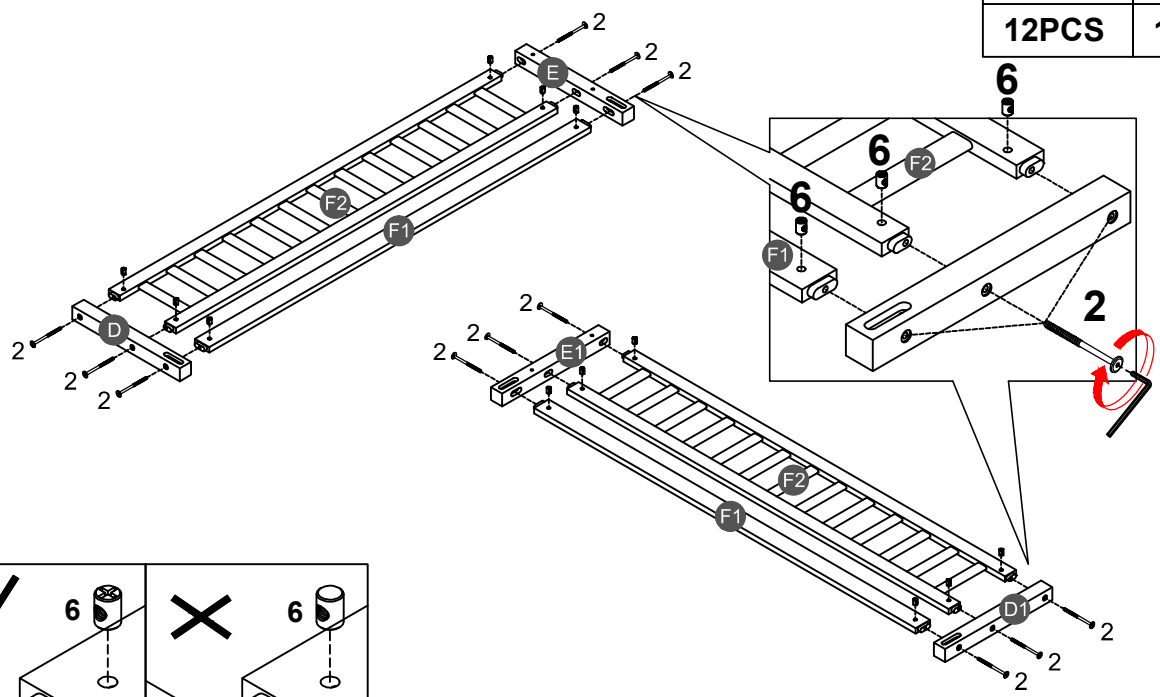

Note: Part 6 will face up with the "x" mark on it, otherwise it cannot be tightened

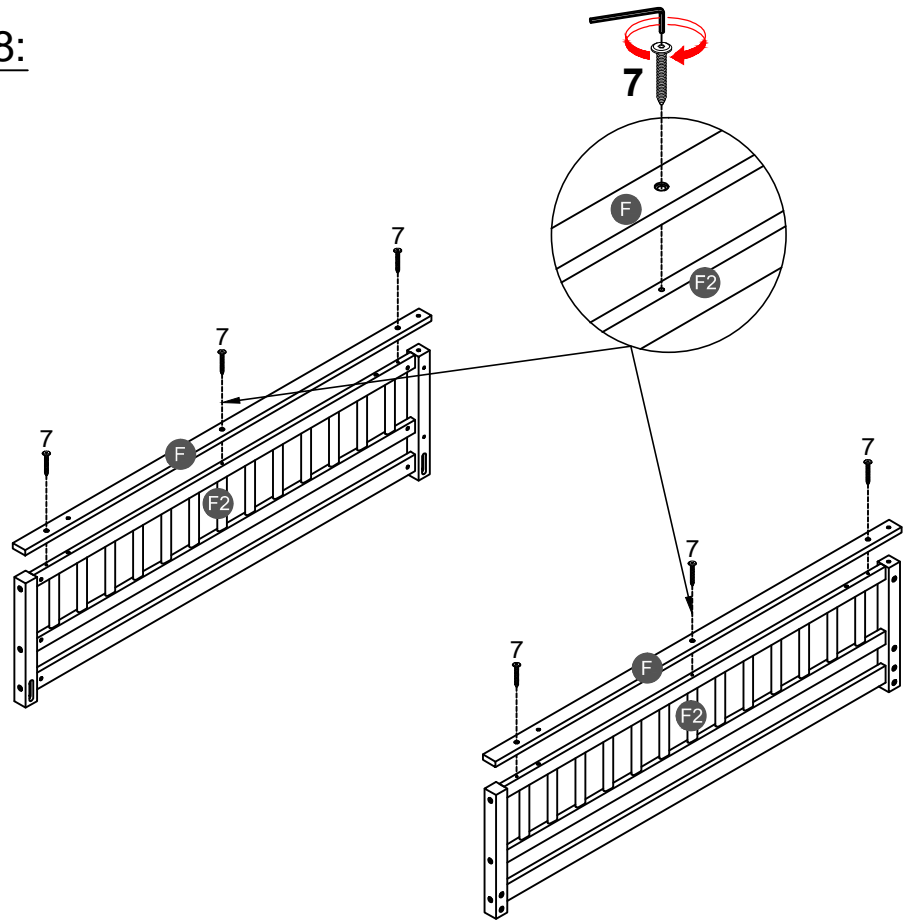

STEP 8:

7	
6PCS	

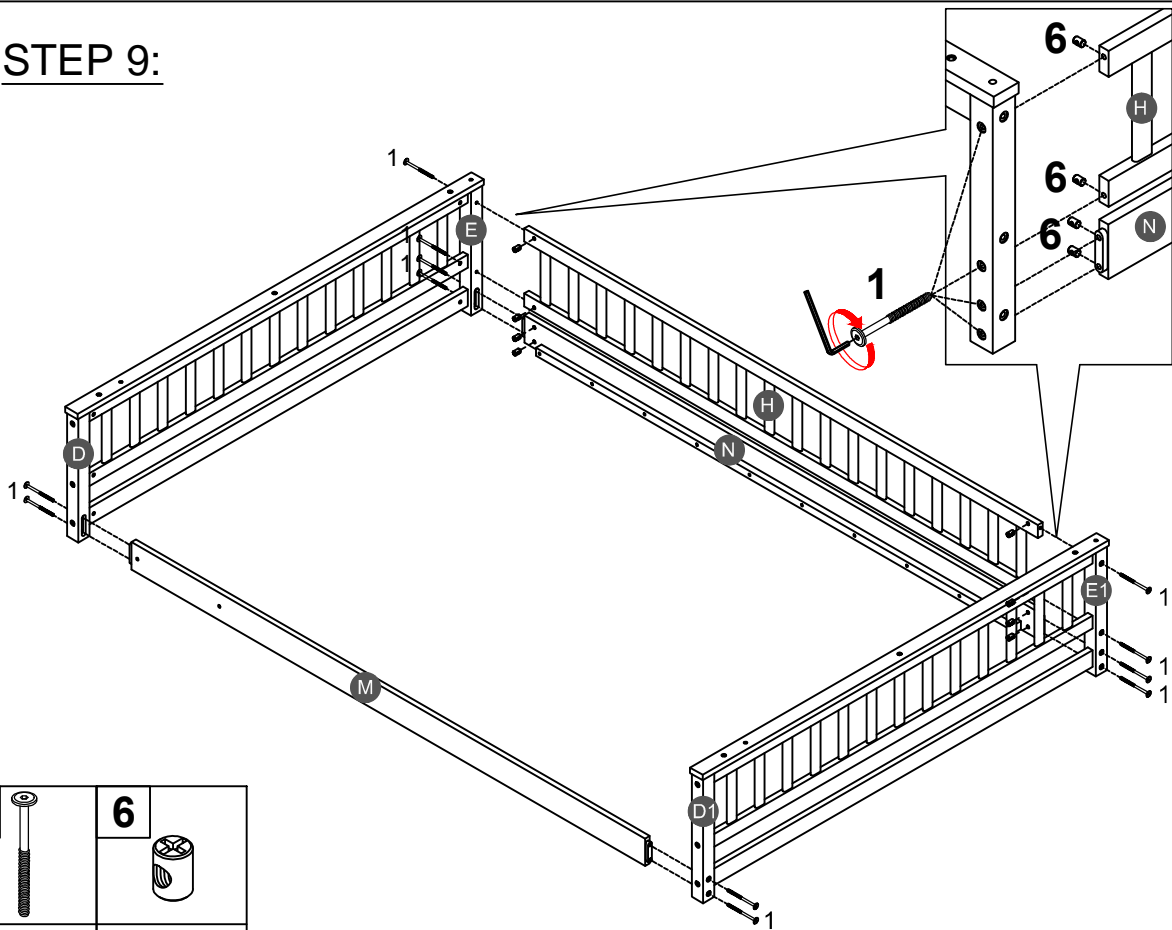

STEP 9:



1	6
	
12PCS	12PCS

STEP 10:

8



14PCS

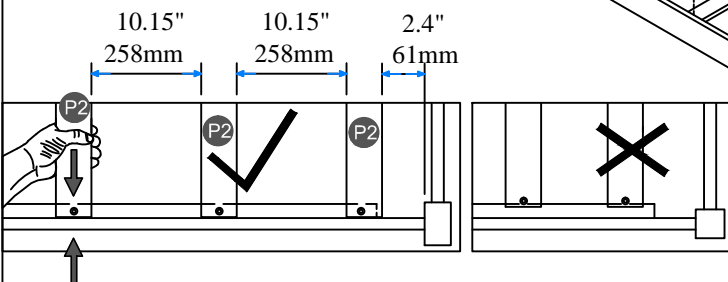
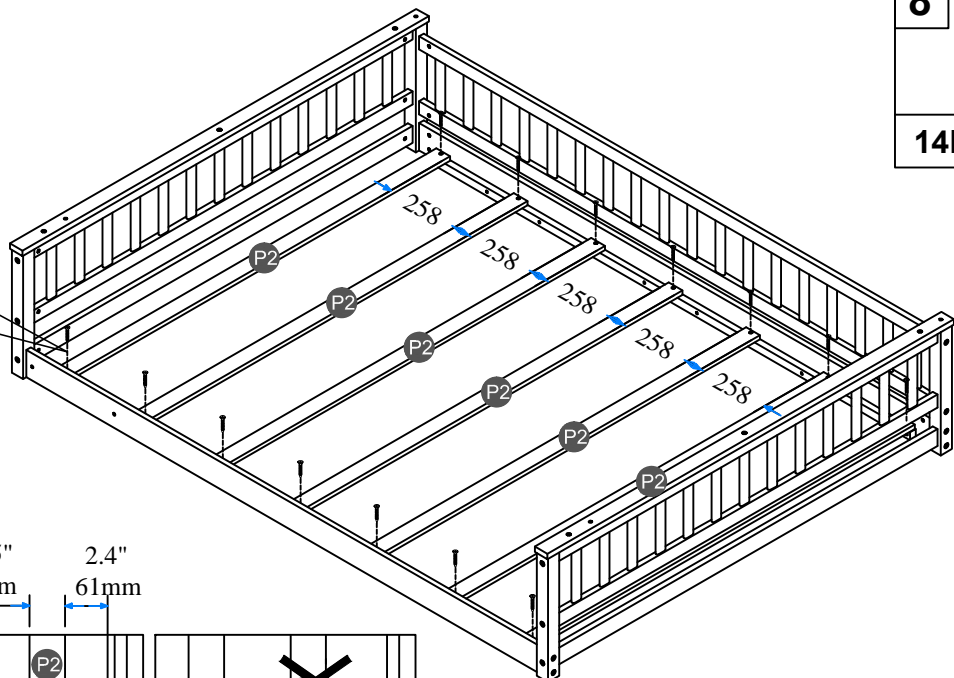
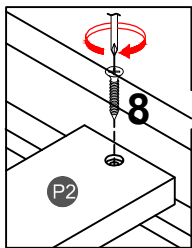

NOTE: Please make sure the bed slats close to the side rail before locking the screws to avoid breakage. This step is required for both the left and right sides. Moreover, please do not lock the screws of the bed slats at the outermost edge to avoid damaging.

STEP 11:

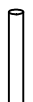
12	
4PCS	

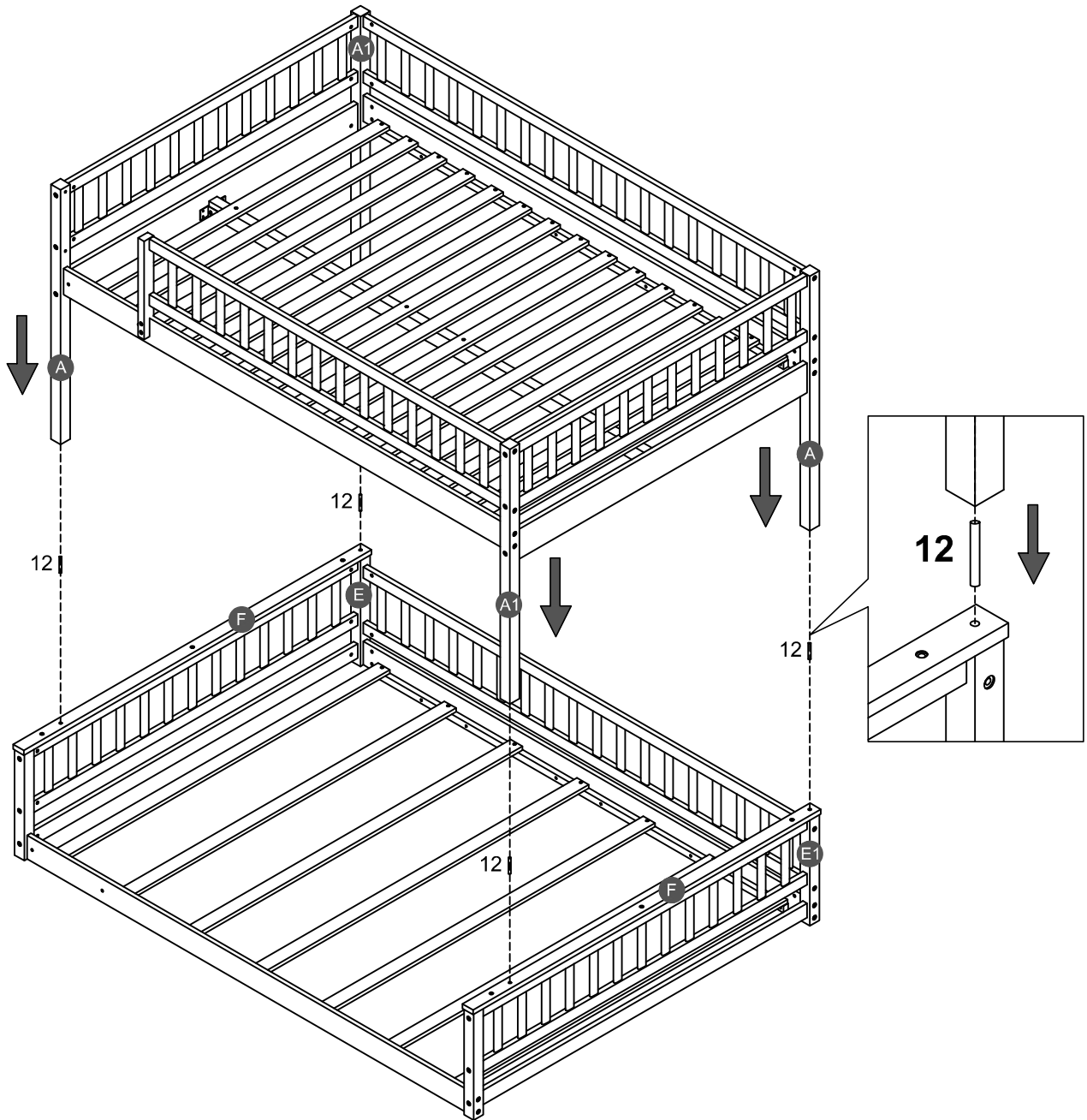

STEP 12:

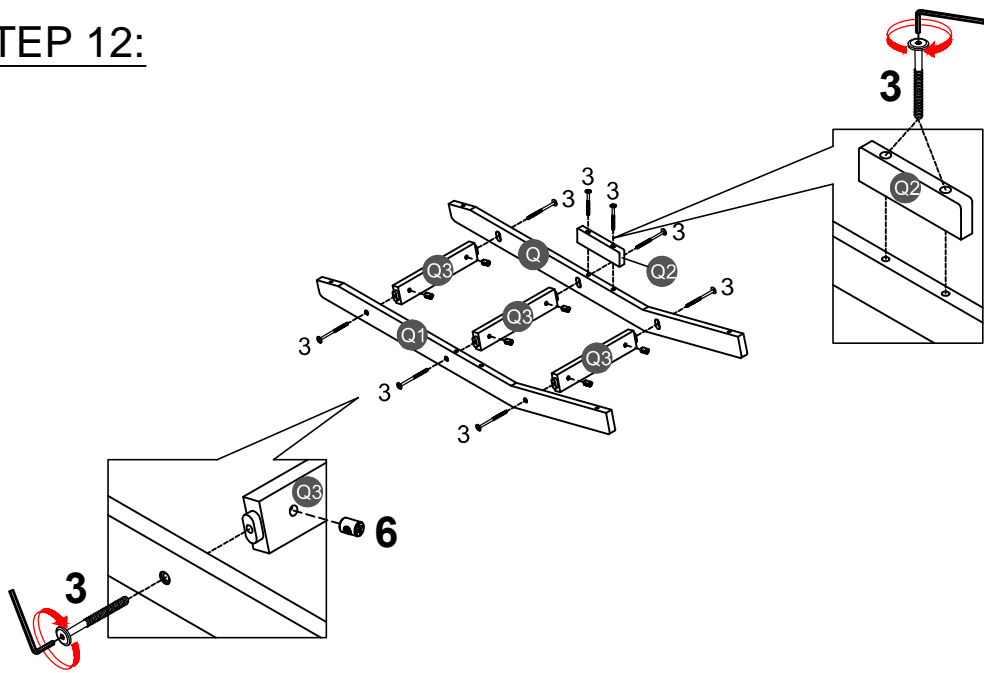

3



8PCS

6



6PCS

STEP 13:

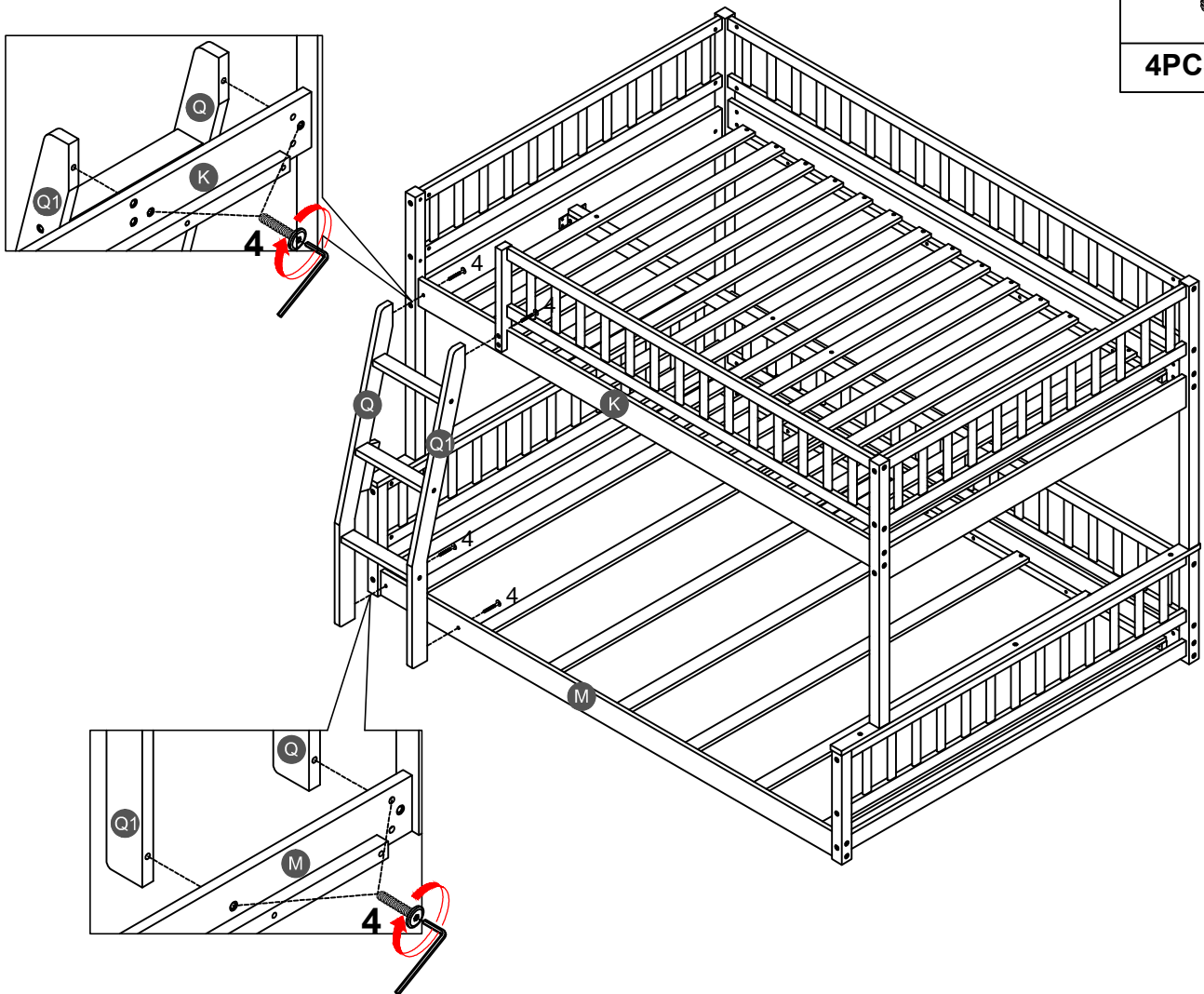

4



4PCS