

Revision Number: 01

42210 Bench

E1900099, E1900100, E1900101

Components

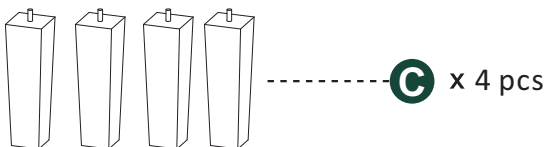
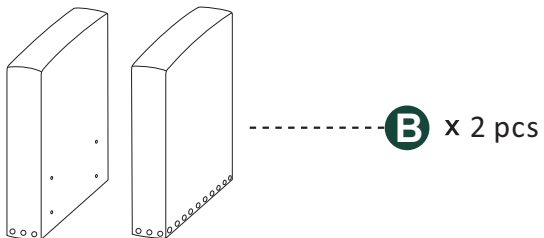
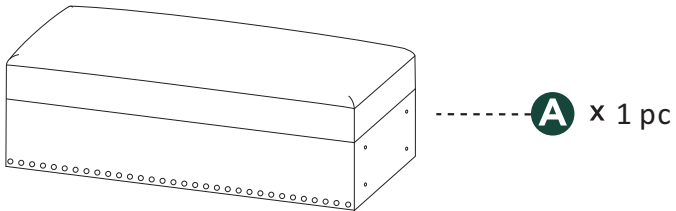

Hardware

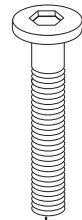

J
M8X40
8 pcs



O
M8
8 pcs



R
M5
1 pc

CAUTION:

When placing furniture on non-carpeted flooring, we recommend the use of floor protection such as an area rug or furniture pads. Area rugs and padding not included with purchase.

Remove Parts From Bench Compartment

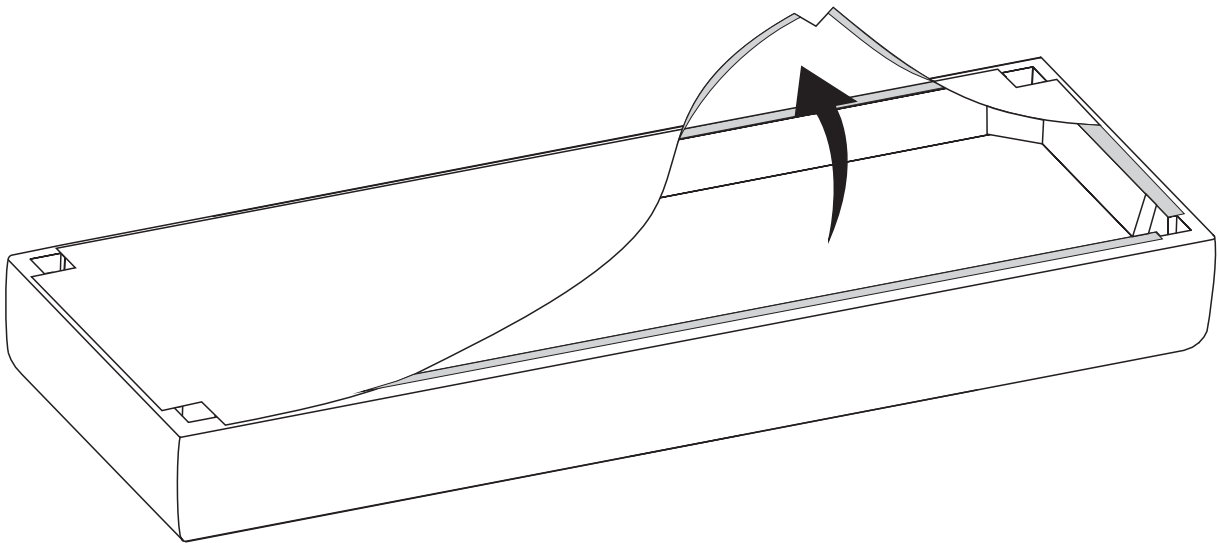

1 Thread legs (C) into bottom of arm (B).

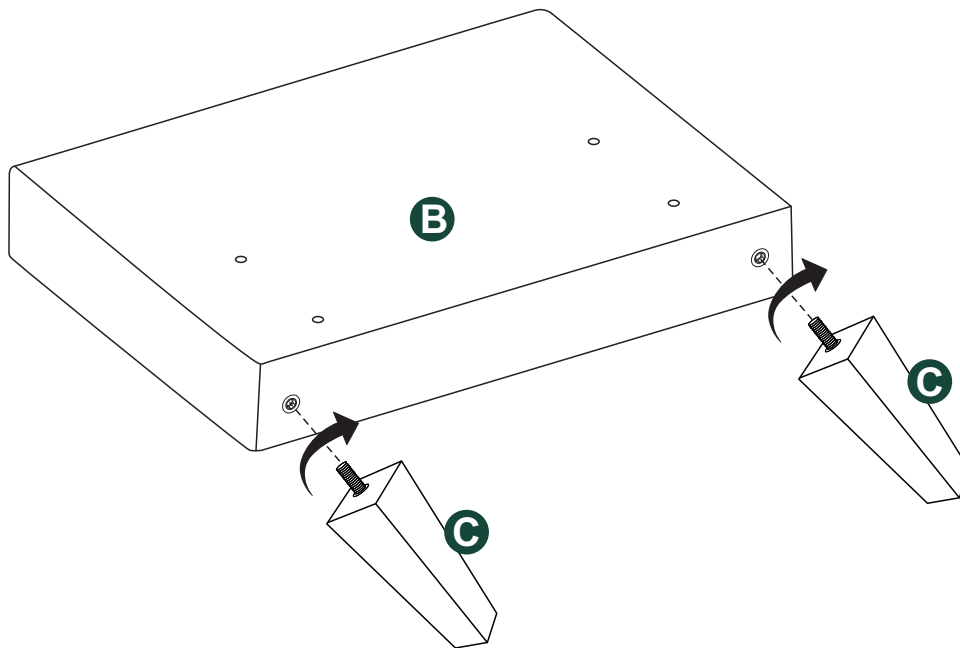

Repeat steps to assemble another set of (B) and (C).

2 Attach (O) washers to (J) bolts. Line up the holes in the arms (B) to the holes in the ends of bench (A), use the bolts (J) to attach two arms (B) to two ends of bench (A). Tighten with Allen key (R).

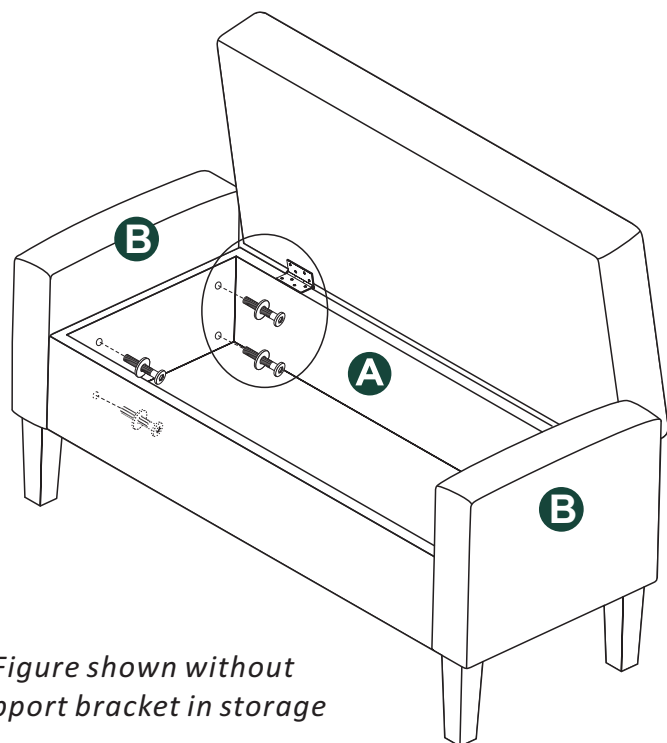
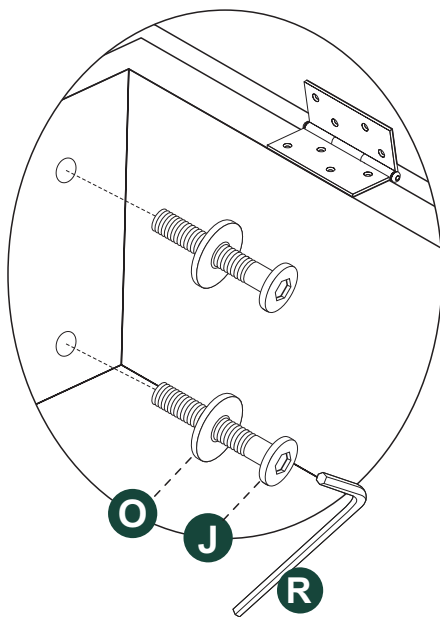
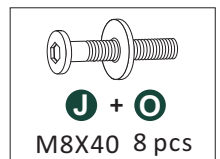

Figure shown without support bracket in storage

You're all finished!