

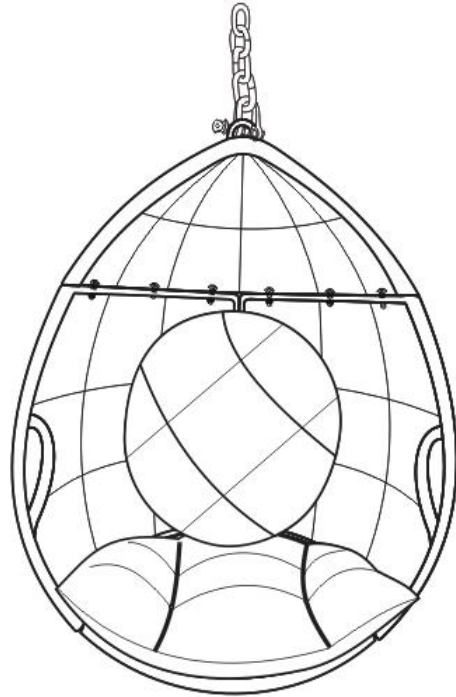

Assembly Instructions

Caution : You must read this before you proceed

BASKET



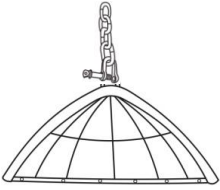
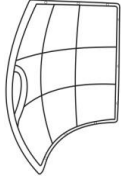



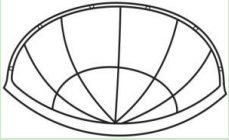
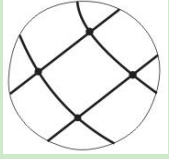
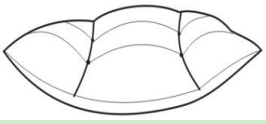

Parts List

Label	Picture	Description	QTY
A		Top	1
B		Left Back	1
C		Right Back	1

D		Seat	1
E		Back Cushion	1
F		Seat Cushion	1

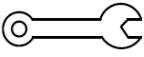
Hardware

Label	Picture	Description	QTY
①		Bolt (M6x25mm)	16
②		Washer (M6)	32
③		Nut	16
④		Bolt Cap	16
⑤		Nut Cap	16
⑥		Spanner	1
⑦		Allen Key	1

Assembly Preparation

Before Beginning Assembly:

 X 16  X 32  X 16

 X 16  X 16

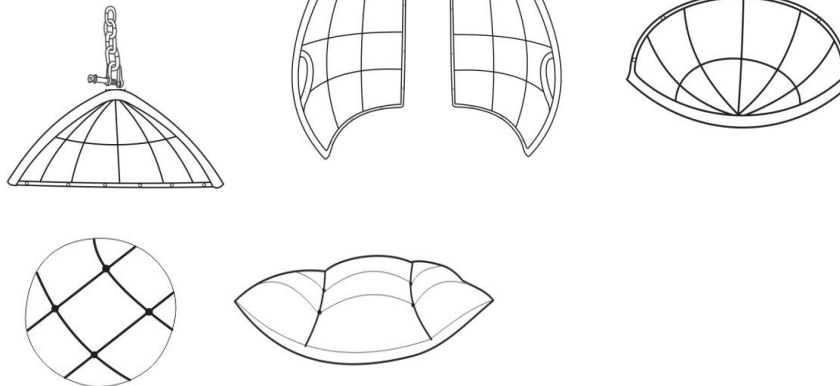

- Read instructions, cover to cover-



- Have 2 adults on hand for assembly-



- Do not assemble on flooring or carpet-



- Assemble on a clean non-marring surface (packing foam)-



- Save all packaging until finished-

Assembly Steps

Overview

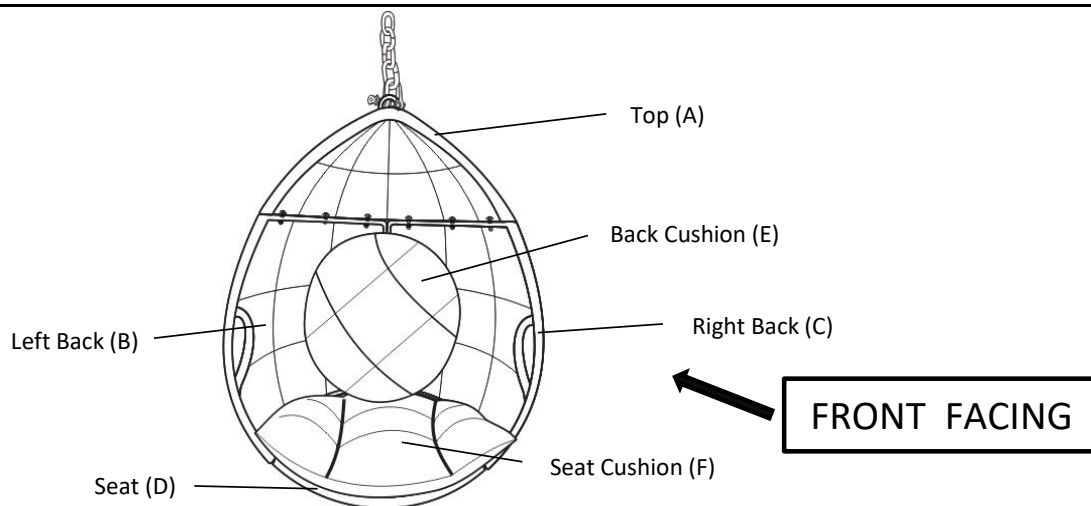

This Basket has multiple parts and may require up to 30 minutes to assemble. To give you an overview of the Basket parts, the above picture is to help you put the various parts into perspective. Please read through the instructions below to familiarise yourself with the parts and steps before assembly.

Step 1

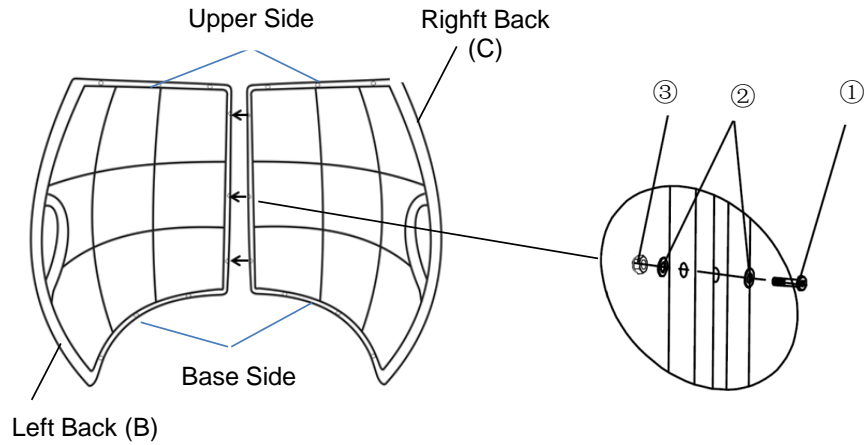

Place the Left Back(B) and Right Back(C) on a clean, non-marring surface.

Note: Find the sticker with the words "upper side" on them, and keep all the upper sides upwards.

Attach Left Back(B) to Right Back(C) using Bolts(①), and Washers(②) on one side and Washers(②) and Nuts(③) on the other side, with Allen Key(⑦) and Spanner(⑥).

Do not fully tighten the Bolts.

Step 2

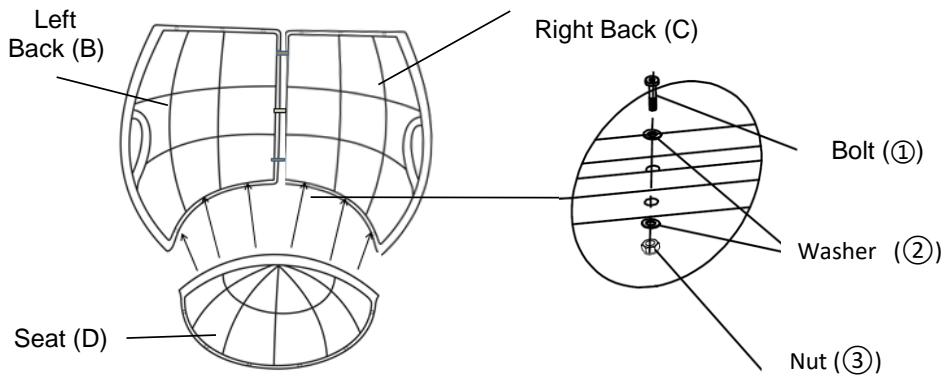

Align Left Back(B), Right Back(C) and Seat(D).

Attach Left Back(B) and Right Back(C) to Seat(D) using Bolts(①), and Washers(②) on the upper side and Washers(②) and Nuts(③) on the lower side, with Allen Key(⑦) and Spanner(⑥).

Do not fully tighten the Bolts.

Step 3

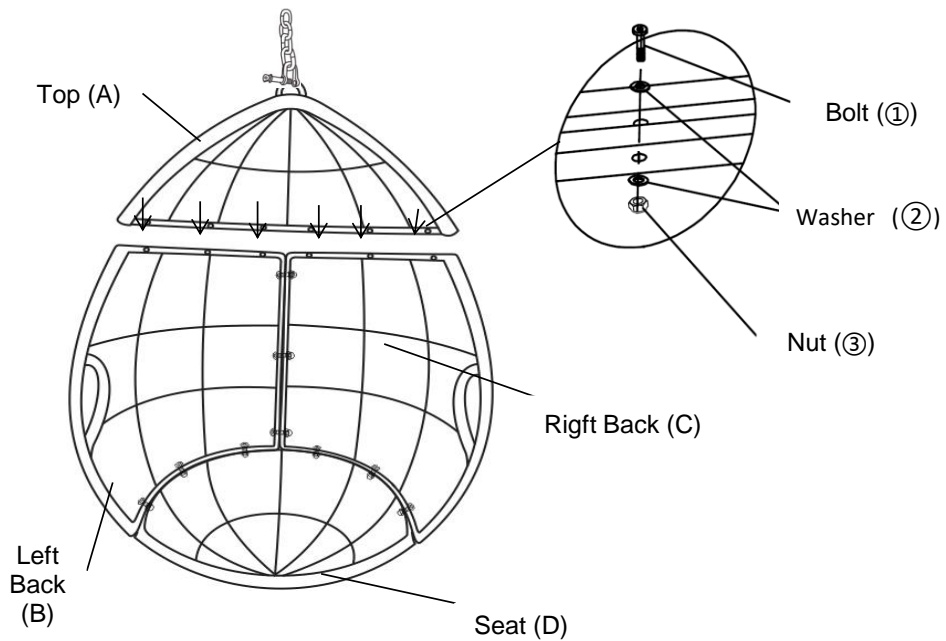

Align Left Back(B), Right Back(C) and Top(A).

Attach Left Back(B) and Right Back(C) to Top(A) using Bolts(①), and Washers(②) on the upper side and Washers(②) and Nuts(③) on the lower side, with Allen Key(⑦) and Spanner(⑥).

Do not fully tighten the Bolts.

Step 4

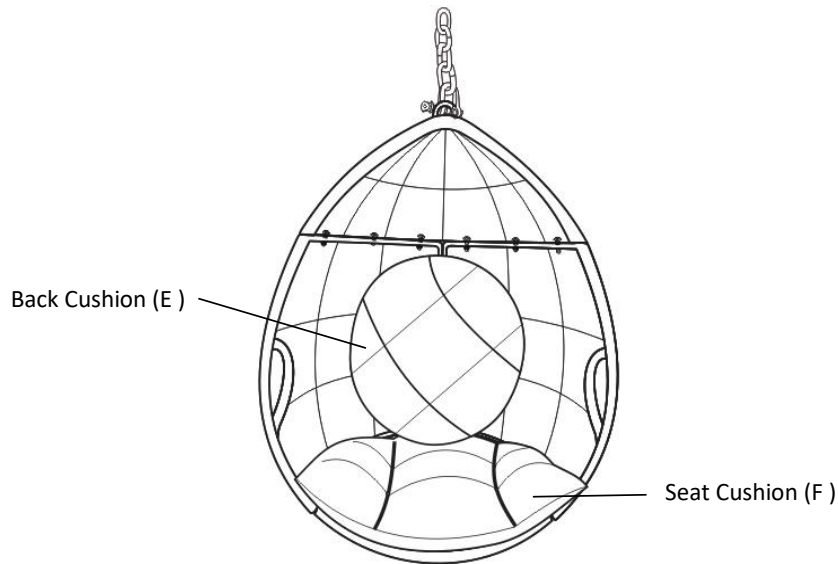

Now, tighten all Bolts and Nuts at all joints sequential manner.

Place Bolt Caps(④) on Bolts(①) and Nut Caps(⑤) on Nuts(③).

Place the Back Cushion (E) and Seat Cushion (F) on the Basket.

Your Basket is ready for use.



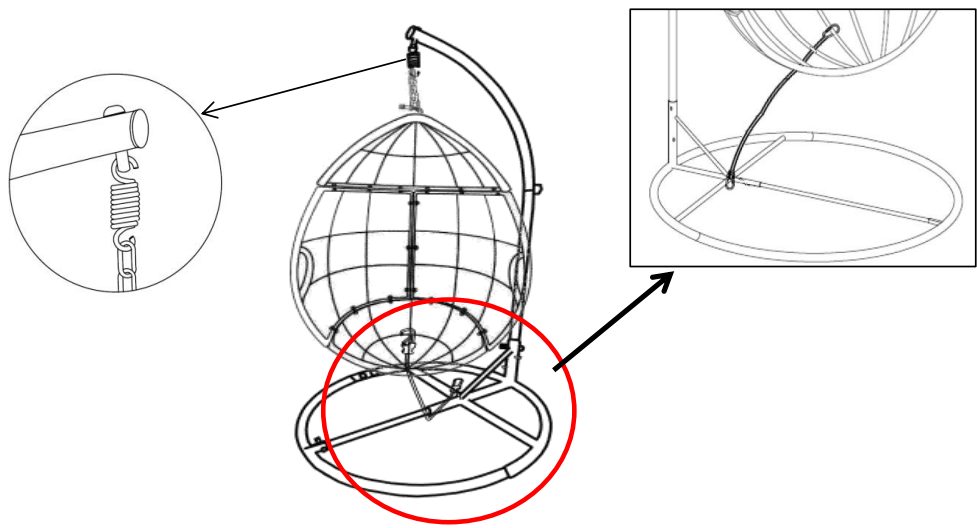

















Step 5



Lift the Basket and hang the first iron chain on the Spring of the Stand.
Use the fasten Safety Rope to lock on the middle rattan warp at the bottom of the basket as shown above, screwed up the carabiner to keep the warp never come out from it.

Note: This step should be completed with 2 adults.

Care & Maintenance

-   ● Do not put hot items directly on furniture surface
-   ● Do not clean furniture with harsh cleansers or polish.
-   ● To obtain the longest lifespan of your outdoor products, minimizing exposure to direct sunlight is recommended.
-   ● Children should not climb or jump on the furniture.
-   ● Do not write on furniture without a padded barrier to protect the surface.
-   ● To obtain the longest lifespan of your outdoor products, avoid extended and lengthy exposure to rain, snow, and direct sunshine. Whenever possible cover the product and /or place under patio or awnings.
-   ● Not for commercial use. For residential use only .
-   ● Stains may be removed with mild soap solution and damp cloth.
-   ● Keep away from sources of ignition.
-   ● Dust and pick-up spills using a clean, non-colored, lint-free cloth.