

# ASSEMBLY INSTRUCTION

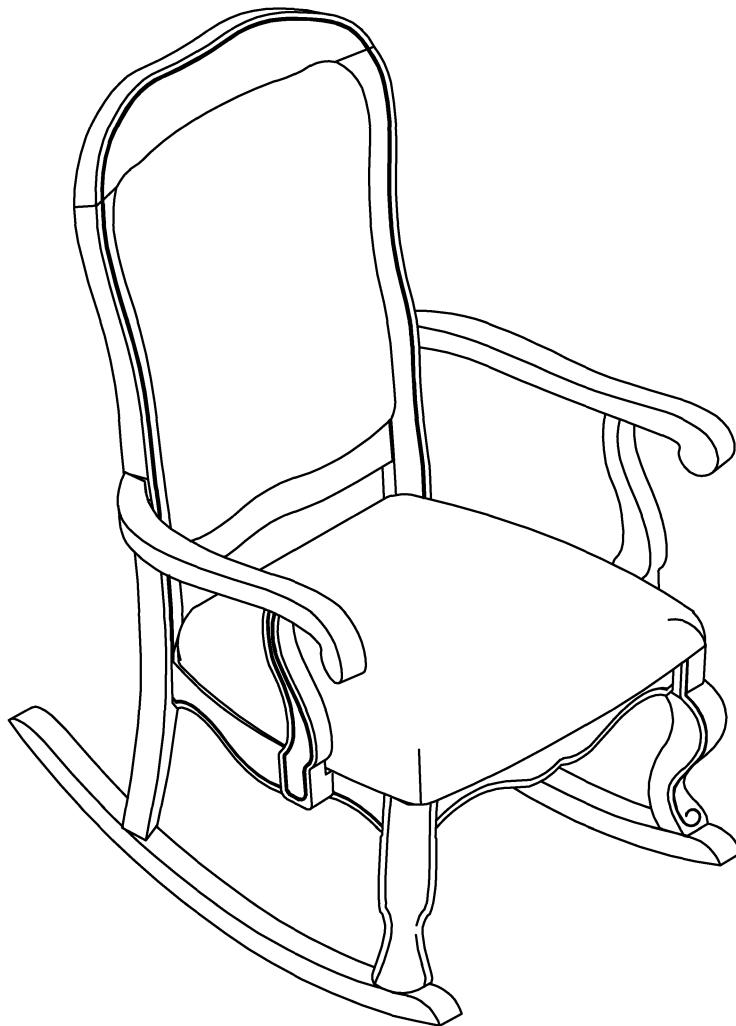















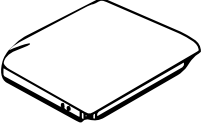

## ASSEMBLY TIPS :

- 1 . Remove hardware from box and sort by size .
- 2 . Please check to see that all hardware and parts are present prior start of assembly .
- 3 . Please follow attached instructions in the same sequense as numbered to assure fast & easy assembly .

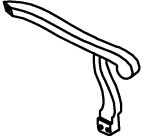

### Warning !

- 1 . Don't attempt to repair or modify parts that are broken or defective . Please contact the store immediately .
- 2 . This product is for home use only and not intended for commercial establishment .

PARTS LIST				HARDWARES REQUIRED			
1	Ø 5/16" x 75mm		4PCS	A	CHAIR BACK		1PCS
2	Ø 5/16" x 66mm		4PCS				
3	Ø 5/16" x 38mm		2PCS				
4	Ø 5/16" x 13mm		10PCS	B	CHAIR SEAT		1PC
5	Ø 5/16" x 19mm		10PCS				
6	Ø 1/4" x 50mm		4PCS	C	FRONT LEG (LEFT & RIGHT)		2PCS
7	Ø 1/4" x 38mm		4PCS				
8	Ø 1/4" x 10.5mm		8PCS	D	LEG		2PCS
9	Ø 1/4" x 12mm		4PCS				
10	Ø 1/4" x 19mm		4PCS				
11	M4		1PC	E	ARM REST (LEFT & RIGHT)		2PCS
12	M4 x 38mm		2PCS				

**STEP 1**

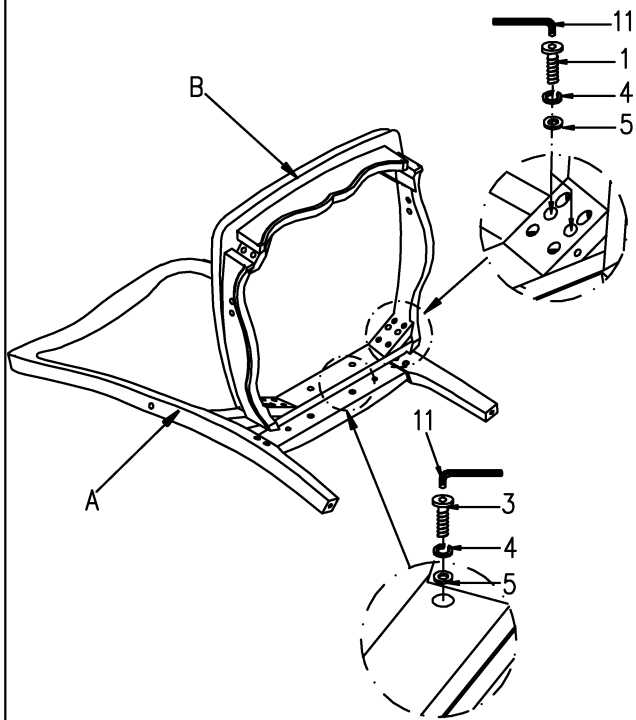

**STEP 2**

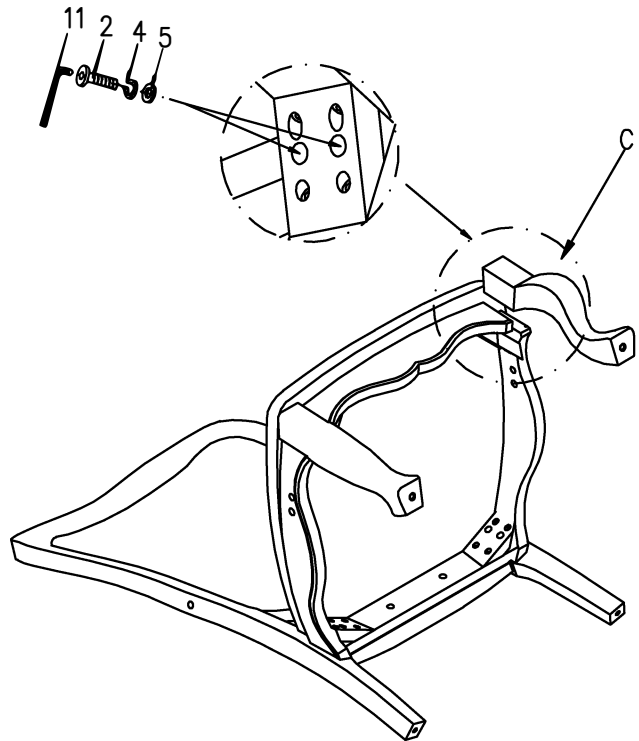

**STEP 3**

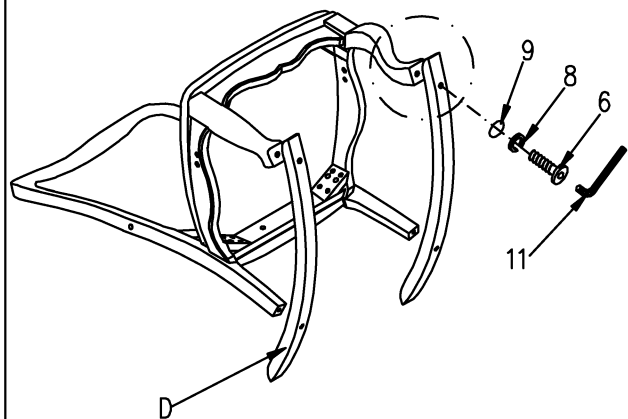

**STEP 4**

