

# INSTRUCTION MANUAL



---

Please retain the packaging for a minimum of 30 days or until you are completely satisfied with your product. Charges may apply to replace the packaging if not retained for return purposes.

# Instructions side 1

2 people recommended  
for assembly

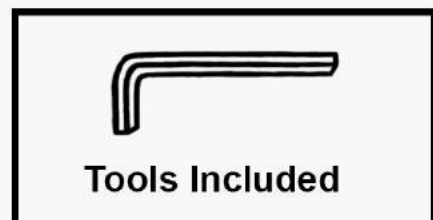
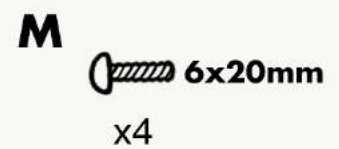
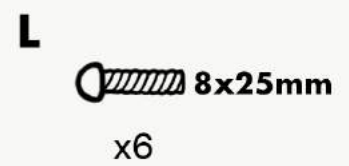
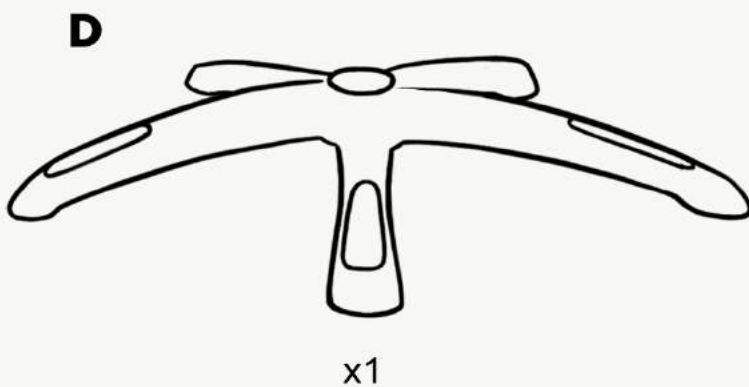
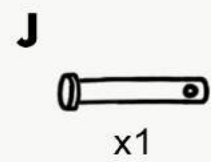
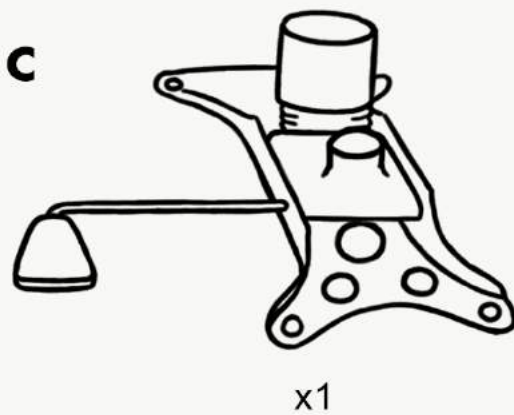
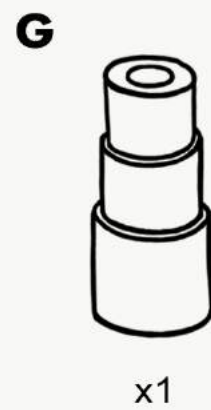
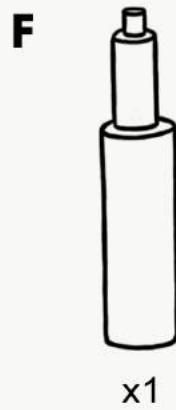
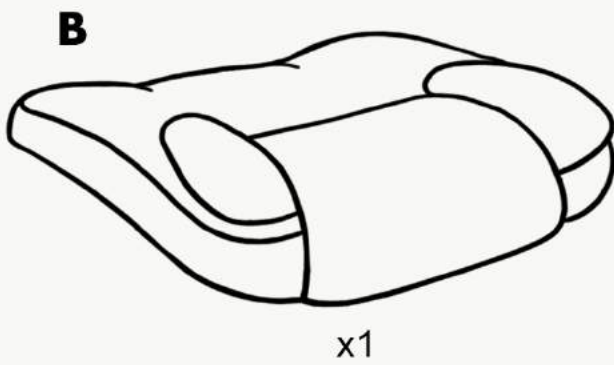
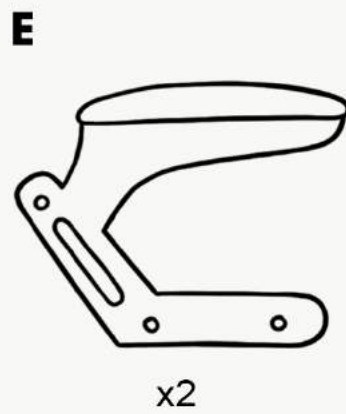
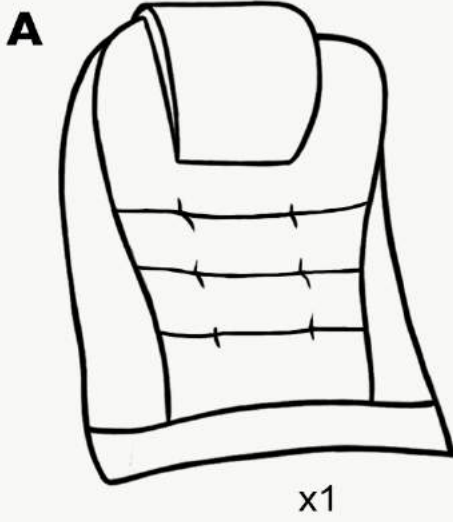

**1**

Insert gas lift (F) into star base (D) and cover with telescopic cover (G). Pop wheels (H) into sockets in D

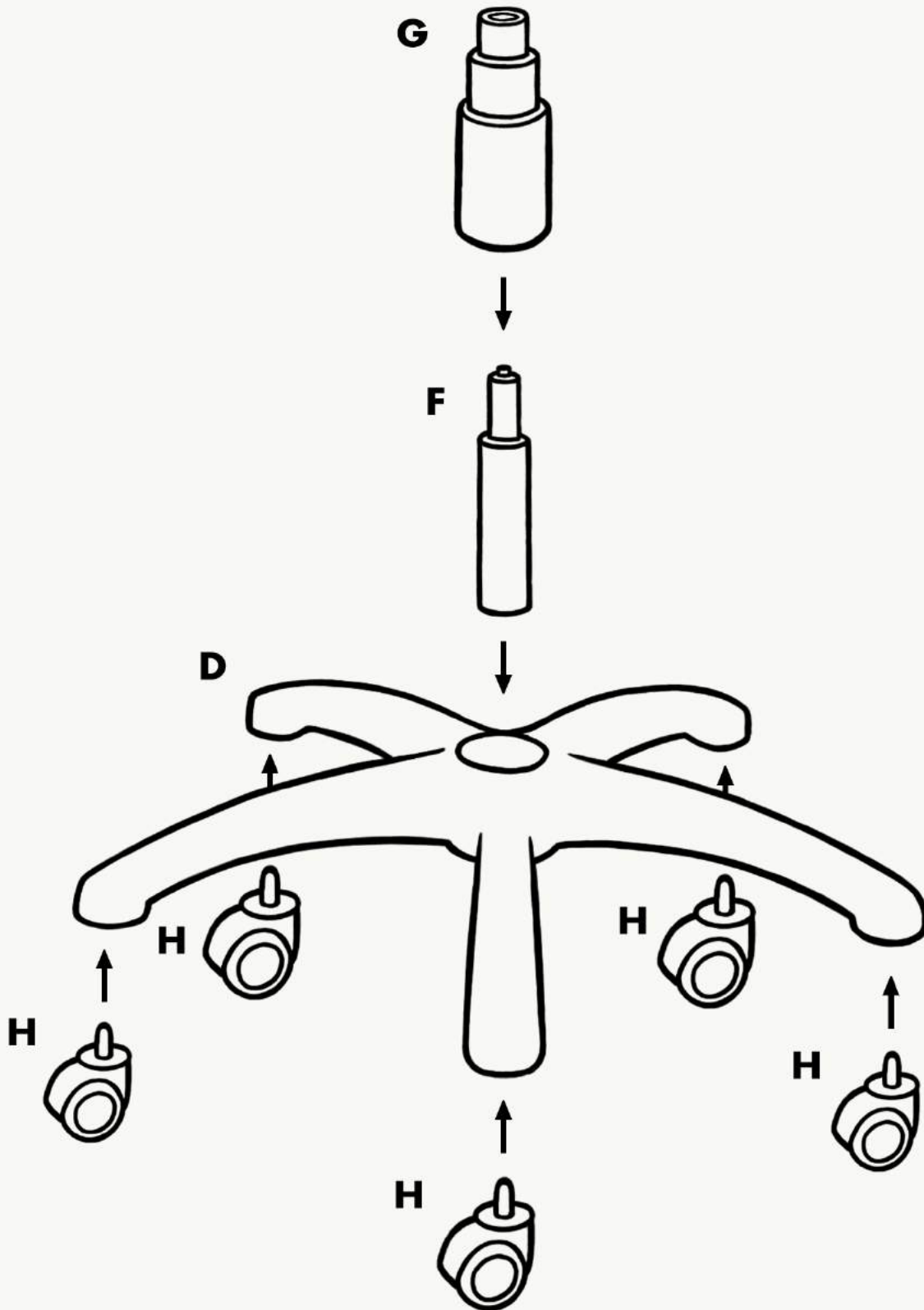

## Instructions side 2

- 2** Screw armrests (E) halfway onto chair back (A) and seat (B). Tighten fully once all screws are in. Then attach screw covers (I)

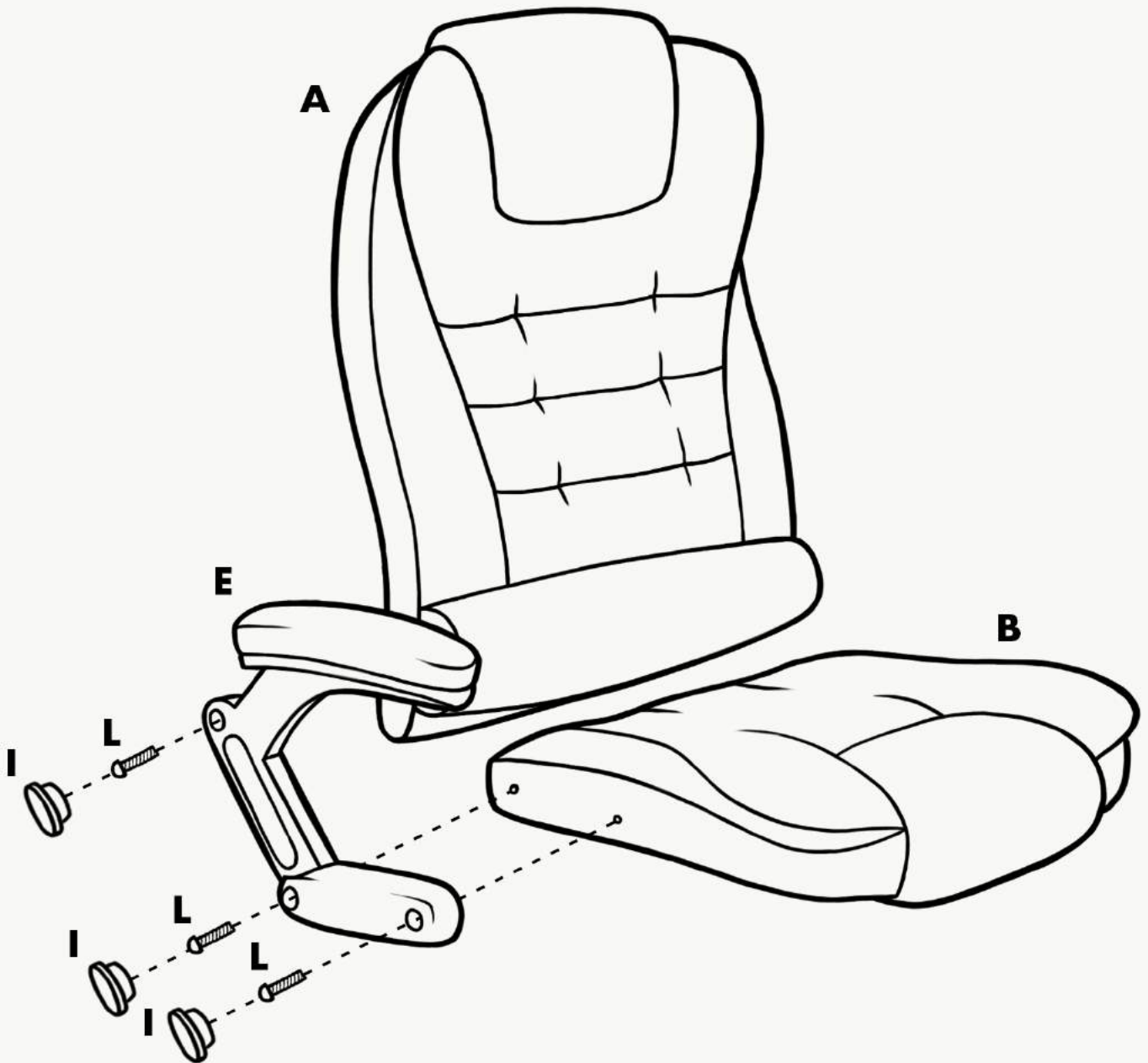

- 3** Screw metal plate (C) onto bottom of seat (B)

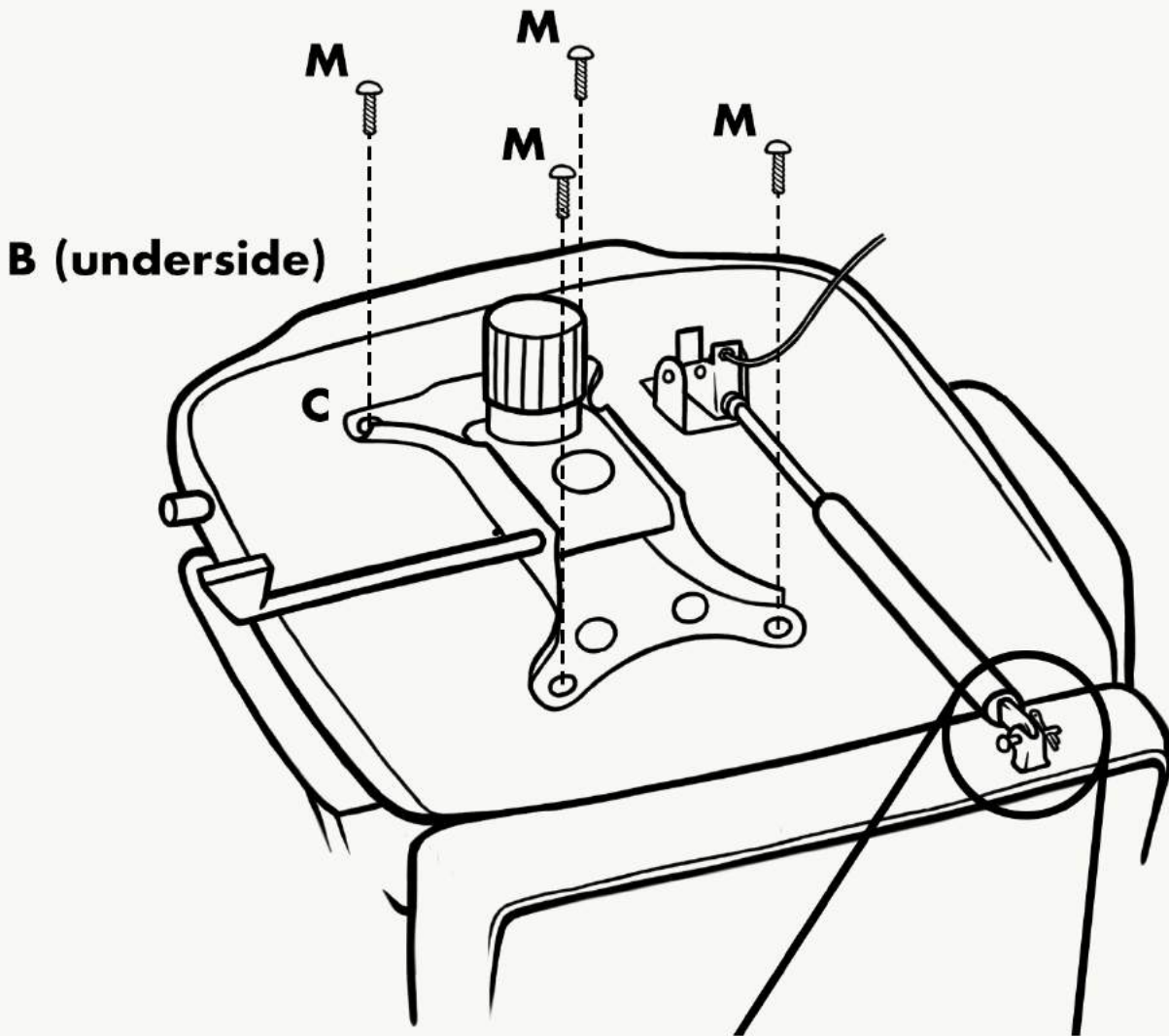

- 4** Insert J through the holes in recline piston and back support. Then insert split pin (K) through hole in J and open split pin

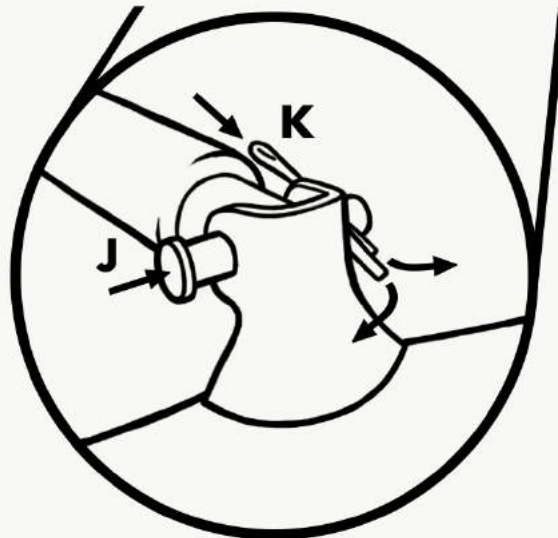

## Instructions side 3

- 5** Insert top of gas lift (F) into hole in metal plate (C)

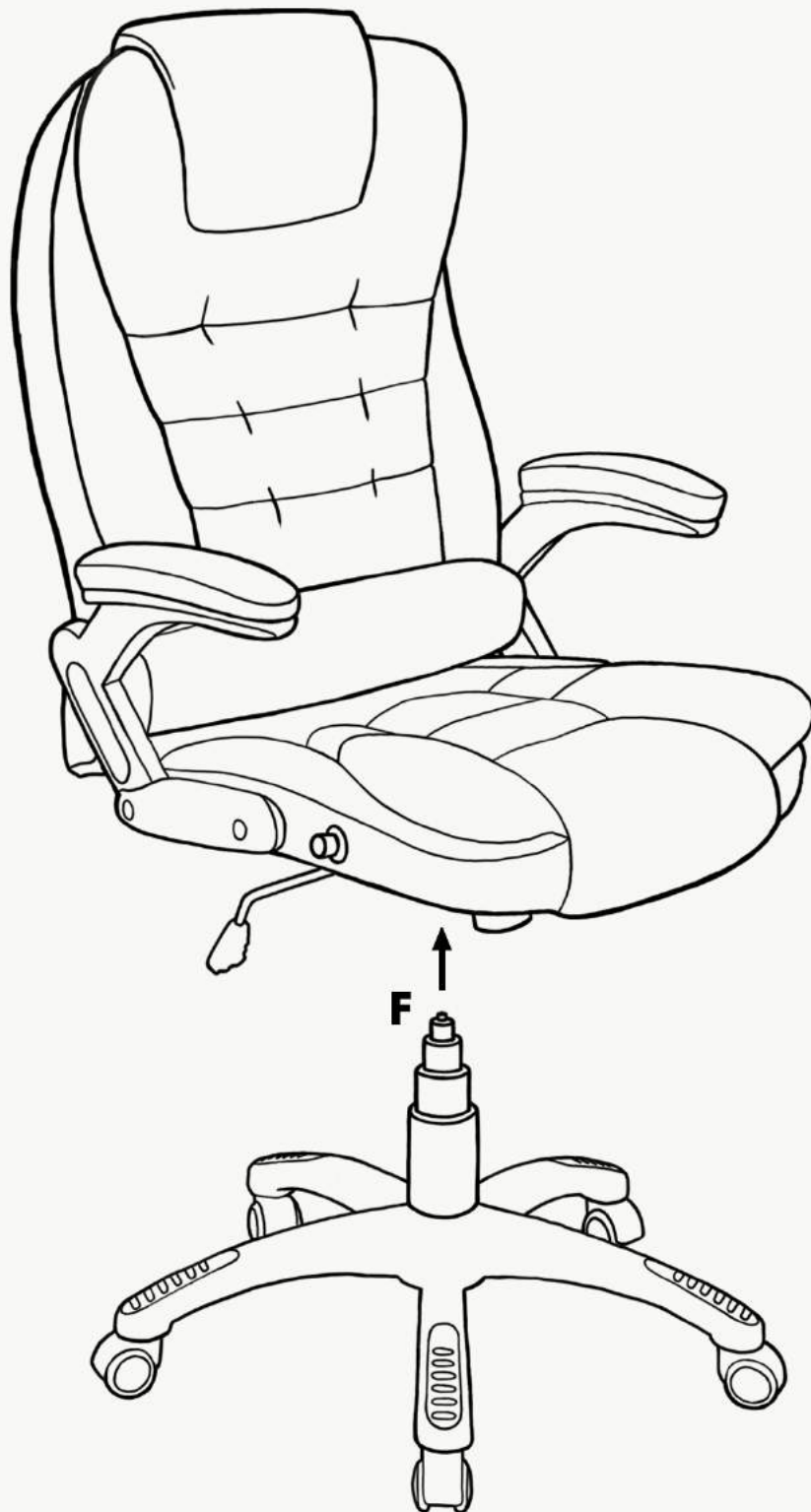

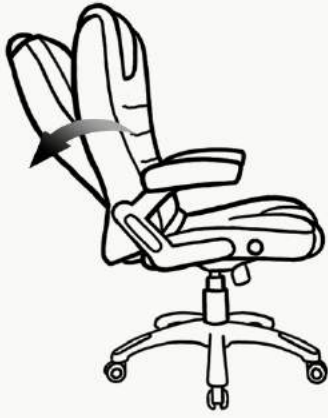

### **Recline function**

Make sure the lever is pushed in.  
Push the button in and lean back firmly



### **Height adjustment**

To raise and lower the seat, lift the lever.



### **Tilt function**

Pull the lever out and lean back



### **Dimensions**

Back height: 75cm

Seat width: 55cm

Seat depth: 53cm

Seat height: 45~55cm

Armrest height: 67~77cm

Armrest length: 27cm

Thank you for choosing us

If you are having difficulty with your product and you need support, please contact