

ASSEMBLY INSTRUCTIONS

INSTRUCTIONS DE MONTAGE

T/F HOUSE BUNK BED *T/F MAISON LIT SUPERPOSÉ*

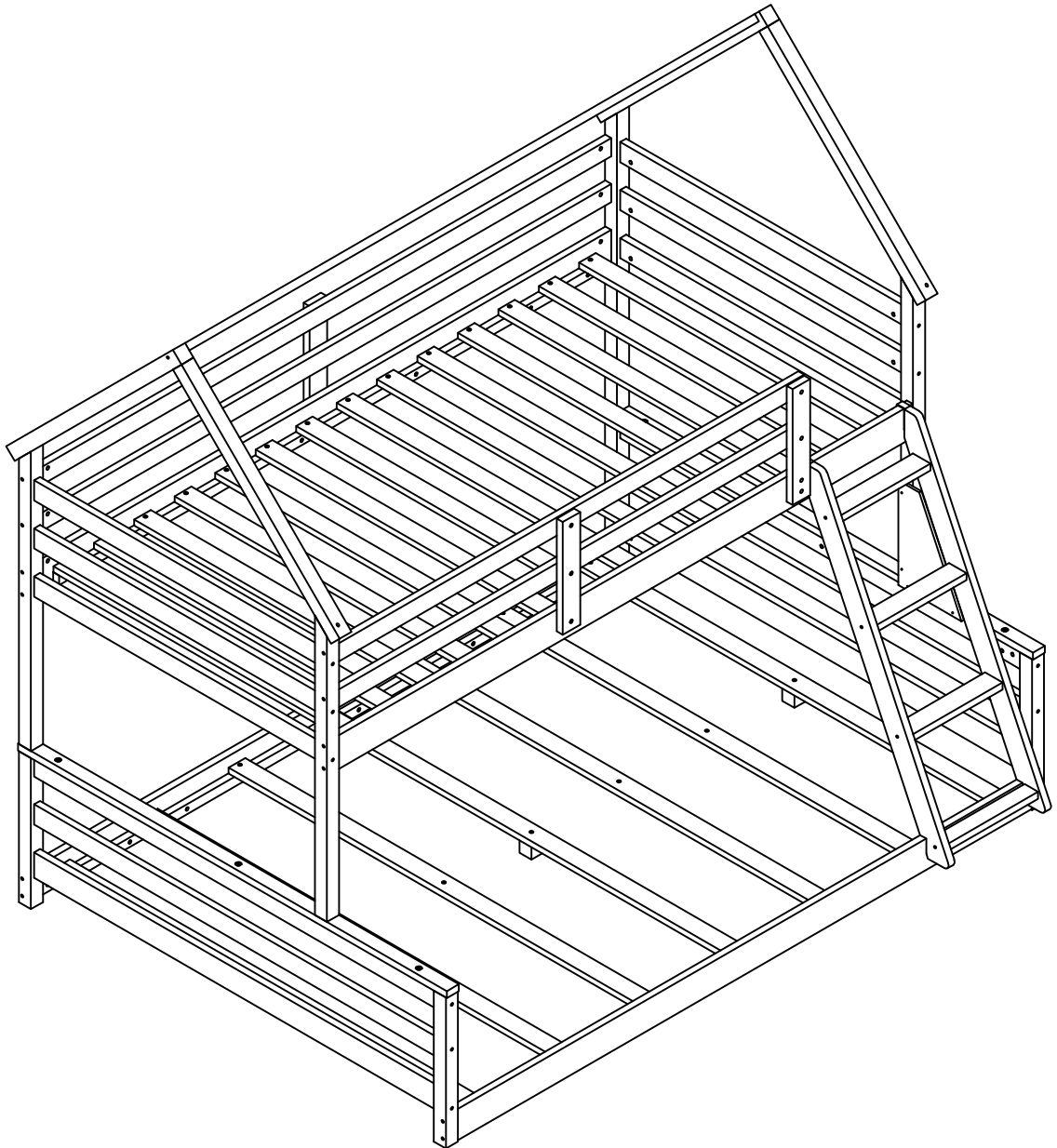

ASSEMBLY INSTRUCTIONS

INSTRUCTIONS DE MONTAGE



SAFETY WARNINGS



1. This bed is designed for use only mattress (es) meeting the following specifications on the upper bunk, and lower bunk:

Upper bunk (bunk bed and tribed included)

Bed Type	Length	Width	Thickness
Full Standard	74" - 75"	53" - 54"	6" max

2. Replacement parts, including additional guardrails, maybe obtained from any of our (GIGACLOUD TECHNOLOGY (USA) INC. 4388 SHIRLEY AVENUE EL MONTE, CA 91731) dealers
3. Follow the information on the warnings appearing on the upper bunk bed end structure and on the carton. Do not remove warning label from bed.
4. Always use the recommended size mattresses or mattress supports, or both, to help prevent the likelihood of entrapment or falls.
5. Surface of mattress must be at least 5" (127mm) below the upper edge of guardrails.
6. Do not allow children under 6 years of age to use the upper bunk.
7. Periodically check and ensure that the guardrail, ladder, and other components are in their proper position, free from damage, and that all connectors are tight.
8. Do not allow horseplay on or under the bed and prohibit jumping on the bed.
9. Always use the ladder for entering and leaving the upper bunk.
10. Do not use substitute part. Contact the manufacture or dealer for replacement part.
11. Use of a night light may provide added safety precaution for a child using the upper bunk.
12. Always use guardrails on both long sides of the upper bunk. If the bunk bed will be placed next to the wall, the guardrail that runs the full length of the bed should be placed against the wall to prevent entrapment between the bed and wall.
13. The use of water or sleep flotation mattresses is prohibited.
14. **STRANGULATION HAZARD** - Never attach or hang items to any part of the bunk bed that are not designed for use with the bed; for example, but not limited to, hook, belts and jump ropes.
15. Keep these instruction for future reference.
16. Prohibit more than one person on upper bunk
17. We recommend assembling your bunk bed on the shipping carton to protect your floor or carpet.
18. Be certain all staples are out of the box before beginning assembly on the shipping carton.

ASSEMBLY INSTRUCTIONS

INSTRUCTIONS DE MONTAGE



AVERTISSEMENTS DE SÉCURITÉ



1. *Ce lit est conçu pour utiliser uniquement des matelas répondant aux spécifications suivantes sur le lit supérieur, et couchette inférieure :*
Couchette supérieure (lits superposés et triblés inclus)

Type de lit	Longueur	Largeur	Épaisseur
Norme complète	74" - 75"	53" - 54"	6" max
2. *Les pièces de rechange, y compris les garde-corps supplémentaires, peuvent être obtenues auprès de l'un de nos (GIGACLOUD TECHNOLOGY (USA) INC. 4388 SHIRLEY AVENUE EL MONTE, CA 91731) revendeurs*
3. *Suivez les informations sur les avertissements apparaissant sur la structure d'extrémité supérieure du lit superposé et sur le carton. Ne retirez pas l'étiquette d'avertissement du lit.*
4. *Utilisez toujours des matelas ou des supports de matelas de taille recommandée, ou les deux, pour éviter le risque de coincement ou chutes.*
5. *La surface du matelas doit être à au moins 5" (127 mm) sous le bord supérieur des garde-corps.*
6. *Ne laissez pas les enfants de moins de 6 ans utiliser le lit supérieur.*
7. *Vérifiez et assurez-vous périodiquement que le garde-corps, l'échelle et les autres composants sont dans leur bonne position, exempt de dommages et que tous les connecteurs sont bien serrés.*
8. *Ne laissez pas les chahuts sur ou sous le lit et interdisez de sauter sur le lit.*
9. *Utilisez toujours l'échelle pour entrer et sortir de la couchette supérieure.*
10. *N'utilisez pas de pièce de rechange. Contactez le fabricant ou le revendeur pour obtenir une pièce de rechange.*
11. *L'utilisation d'une veilleuse peut fournir une mesure de sécurité supplémentaire pour un enfant utilisant le lit supérieur.*
12. *Utilisez toujours des garde-corps sur les deux côtés longs du lit supérieur. Si le lit superposé est placé à côté du mur, le garde-corps qui s'étend sur toute la longueur du lit doit être placé contre le mur pour éviter tout coincement entre le lit et le mur.*
13. *L'utilisation de matelas flottants à eau ou de sommeil est interdite.*
14. **RISQUE D'ÉTRANGULATION** - *N'attachez ou ne suspendez jamais d'objets à une partie du lit superposé qui ne sont pas conçu pour être utilisé avec le lit ; par exemple, mais sans s'y limiter, les crochets, les ceintures et les cordes à sauter.*
15. *Conservez ces instructions pour référence future.*
16. *Interdire plus d'une personne sur la couchette supérieure*
17. *Nous vous recommandons d'assembler votre lit superposé sur le carton d'expédition pour protéger votre sol ou votre tapis.*
18. *Assurez-vous que toutes les agrafes sont sorties de la boîte avant de commencer l'assemblage sur le carton d'expédition.*



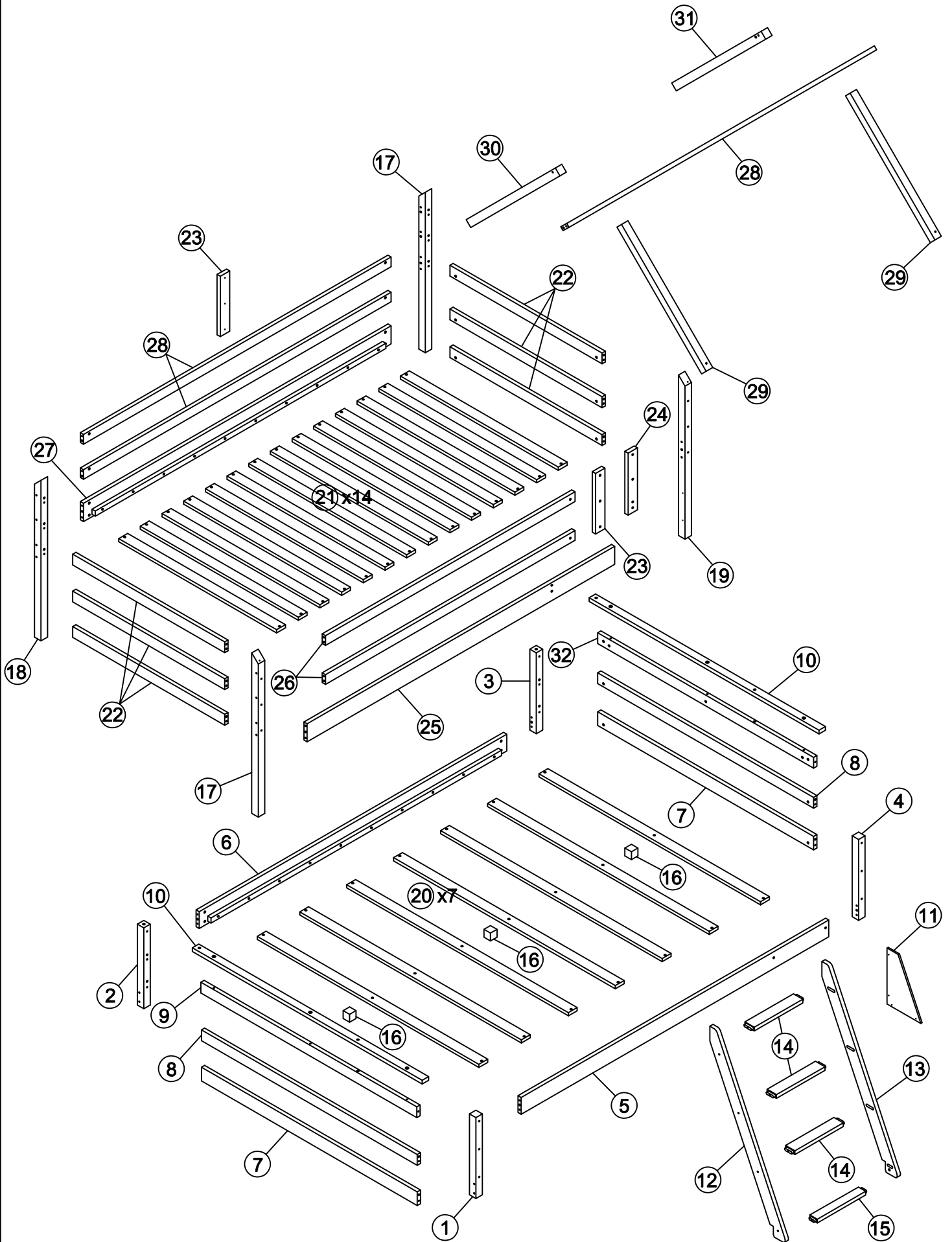



ASSEMBLY INSTRUCTIONS

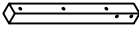
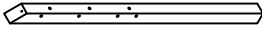
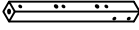
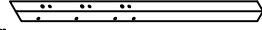
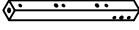
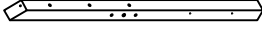
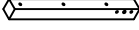
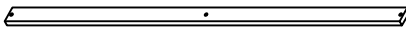
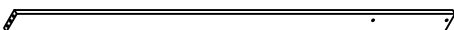
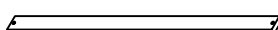
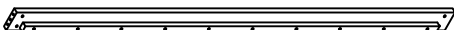
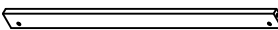
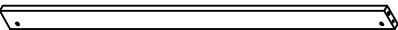
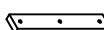
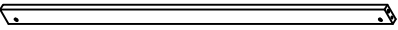
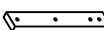
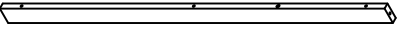
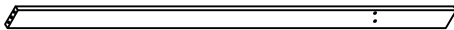

ASSEMBLY INSTRUCTIONS

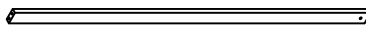
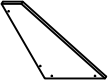
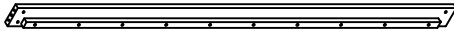
(Hardware in this SKU)

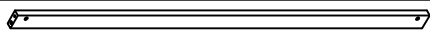
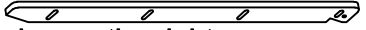
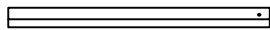
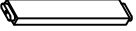
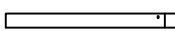
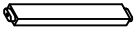
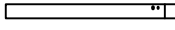















Liste des pieces

1	Left front leg Jambe avant gauche		1pc	17	Leg Jambe		2pcs
2	Left back leg Jambe arrière gauche		1pc	18	Left back leg Jambe arrière gauche		1pc
3	Right back leg Jambe arrière droite		1pc	19	Right front leg Jambe avant droite		1pc
4	Right front leg Jambe avant droite		1pc	20	Wooden slats downstairs Lattes de bois en bas		7pcs
5	Front side rail Rail latéral avant		1pc	21	Wooden slats upstairs Lattes de bois à l'étage		14pcs
6	Back side rail Rail latéral arrière		1pc	22	Headboard panel Panneau de tête de lit		6pcs
7	Headboard panel Panneau de tête de lit		2pcs	23	Back railing supports Supports de garde-corps arrière		2pcs
8	Headboard panel Panneau de tête de lit		2pcs	24	Front railing supports Supports de garde-corps avant		1pc
9	Headboard panel Panneau de tête de lit		1pc	25	Front side rail Rail latéral avant		1pc
10	Headboard panel Panneau de tête de lit		2pcs	26	Front guardrail Garde-corps avant		2pcs
11	Side panels Des panneaux latéraux		1pc	27	Back side rail Rail latéral arrière		1pc
12	Sliding leg on the left Jambe coulissante à gauche		1pc	28	Back guardrail Garde-corps arrière		3pcs
13	Sliding leg on the right Jambe coulissante à droite		1pc	29	Roof top Toit		2pcs
14	Push support Prise en charge poussée		3pcs	30	Roof top Toit		1pc
15	Push the base plate Poussez la plaque de base		1pc	31	Roof top Toit		1pc
16	Support leg Jambe d'appui		3pcs	32	Headboard panel Panneau de tête de lit		1pc

ASSEMBLY INSTRUCTIONS

(Hardware in this SKU)

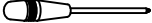



Liste du matériel

A	Ø4x30		51PCS	H	Ø10x40		36PCS
B	Ø4x15		6PCS	I	1/4x30	 	4PCS
C	Ø4x20		4PCS	J	70x18x2		2PCS
D	1/4x90	 	48PCS	K	6.5x80		2PCS
E	1/4x60	 	16PCS	L	6.5x60		4PCS
F	4x58		1PC		Phillip head screw Not include		
G	Ø12x80		4PCS				

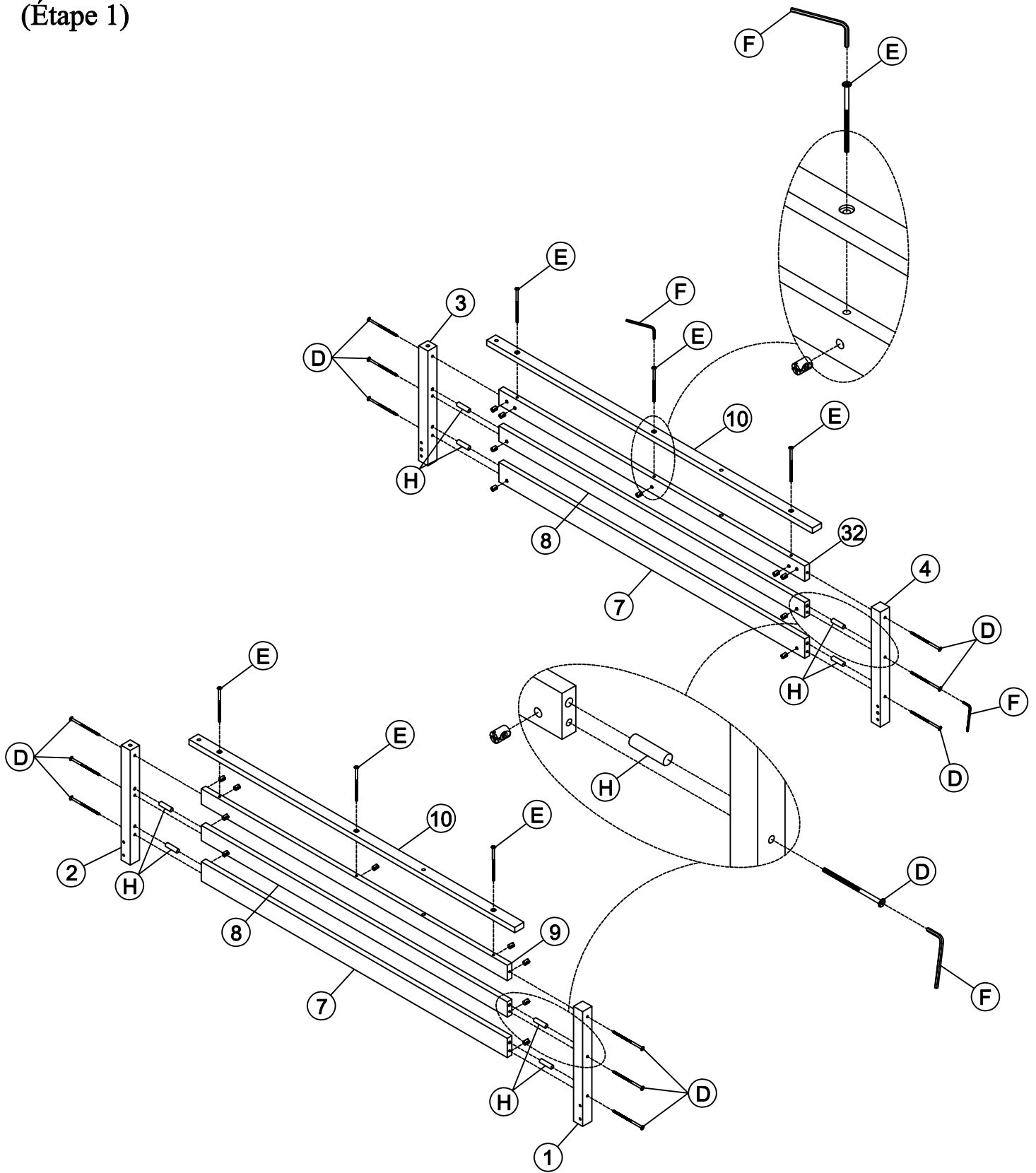
ASSEMBLY INSTRUCTIONS

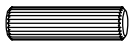
Step 1 (Étape 1)





H	Ø10x40		8PCS	F	4x58		1PC
E	1/4x60		6PCS	D	1/4x90		12PCS

ASSEMBLY INSTRUCTIONS

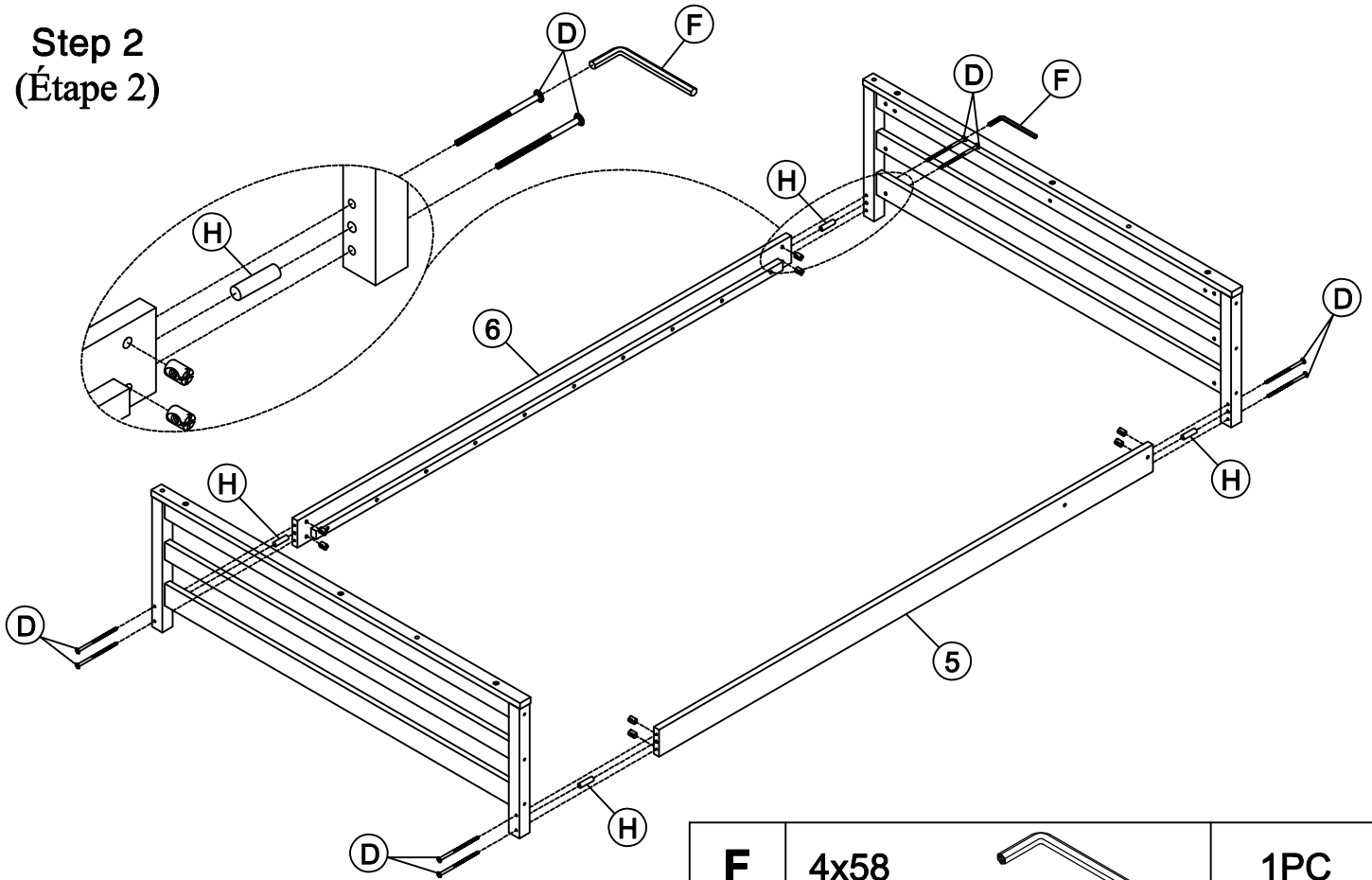

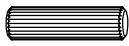
Step 2 (Étape 2)

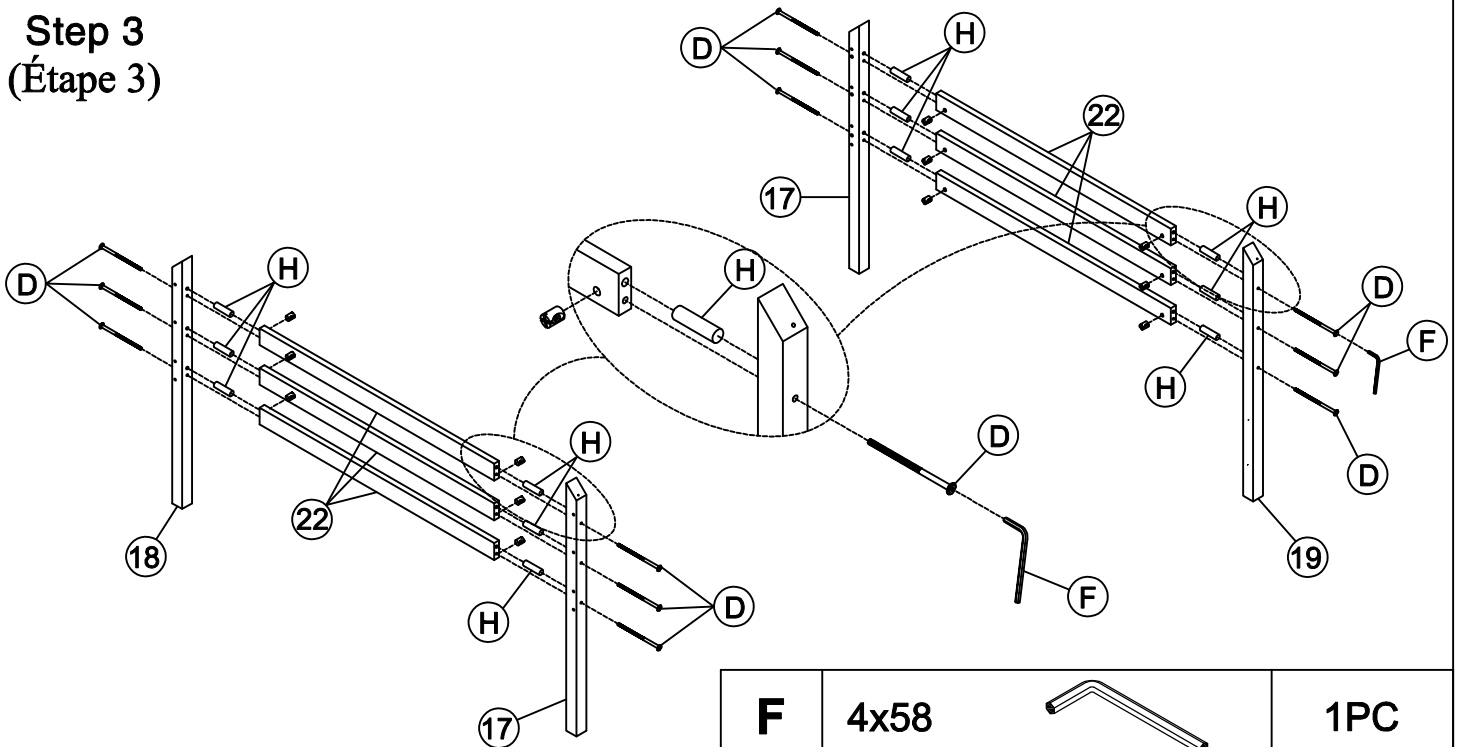

F	4x58		1PC
H	Ø10x40		4PCS
D	1/4x90		8PCS

Step 3 (Étape 3)





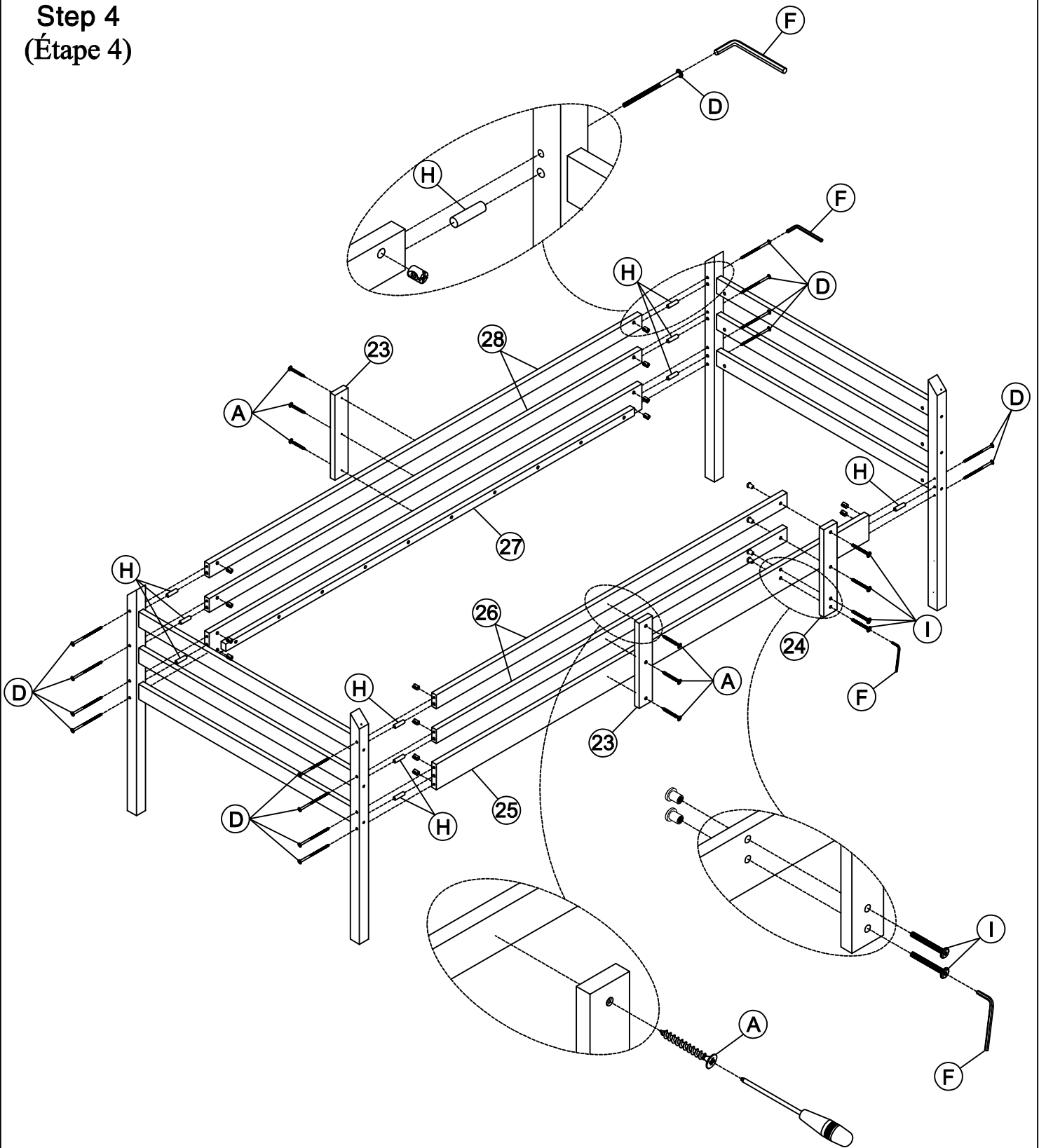

F	4x58		1PC
H	Ø10x40		12PCS
D	1/4x90		12PCS

ASSEMBLY INSTRUCTIONS

Step 4 (Étape 4)



I	1/4x30		4PCS				
A	Ø4x30		6PCS	F	4x58		1PC
H	Ø10x40		10PCS	D	1/4x90		14PCS

ASSEMBLY INSTRUCTIONS

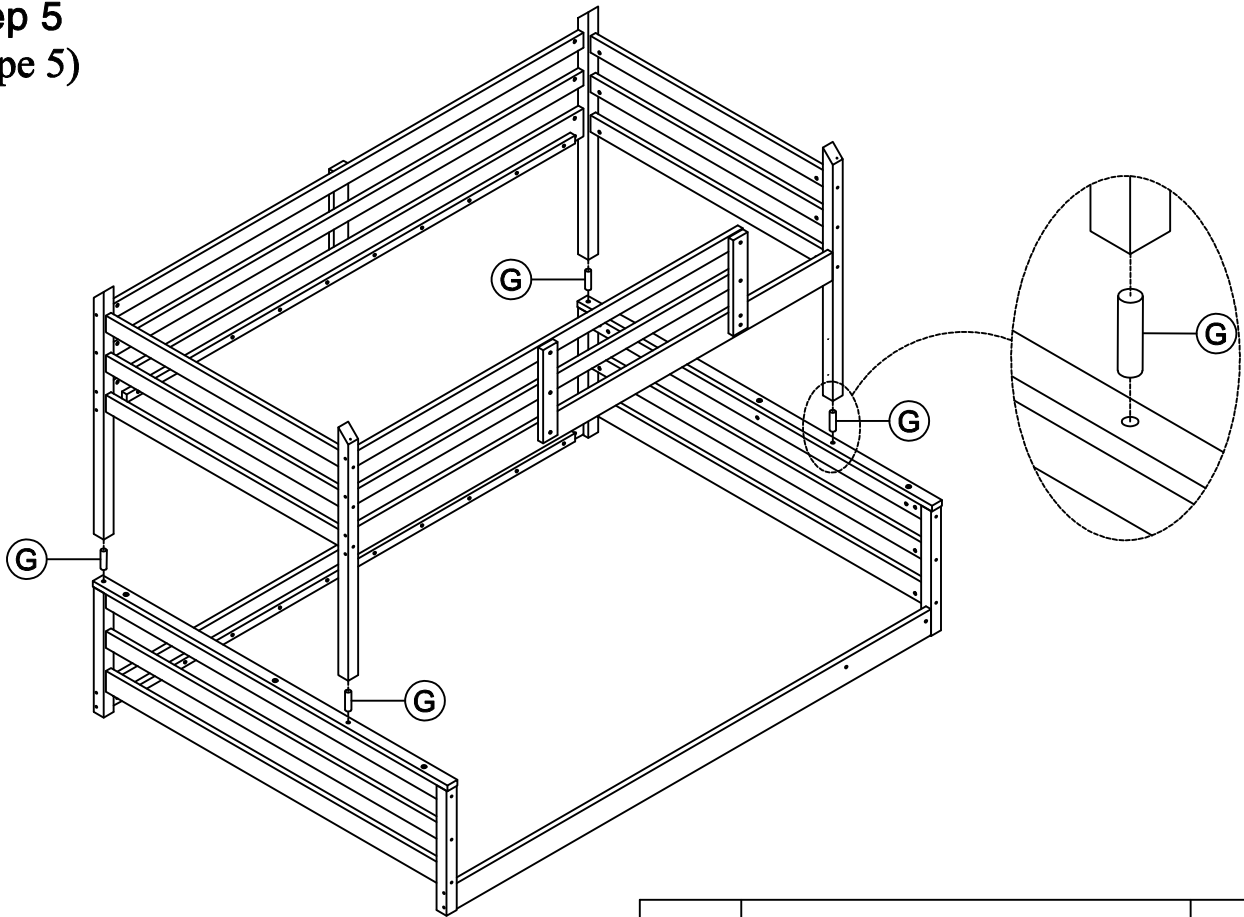

Step 5 (Étape 5)

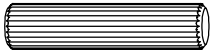

G	Ø12x80		4PCS
----------	--------	---------------------------------------------------------------------------------------	------

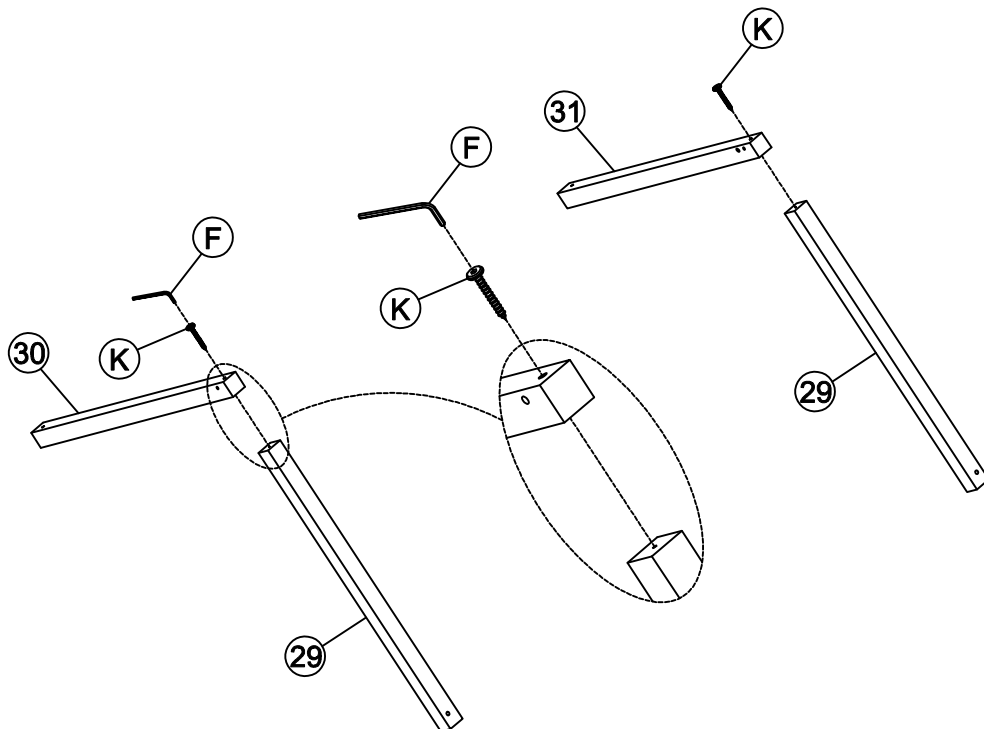
Step 6 (Étape 6)





K	6.5x80		2PCS	F	4x58		1PC
----------	--------	-------------------------------------------------------------------------------------	------	----------	------	---------------------------------------------------------------------------------------	-----

ASSEMBLY INSTRUCTIONS

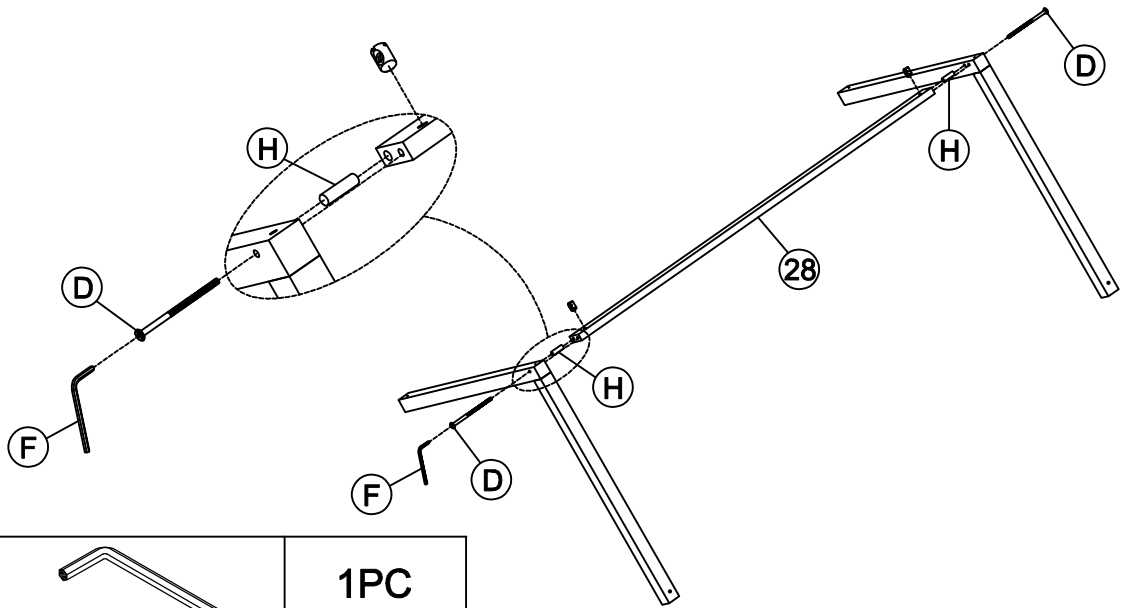

Step 7 (Étape 7)

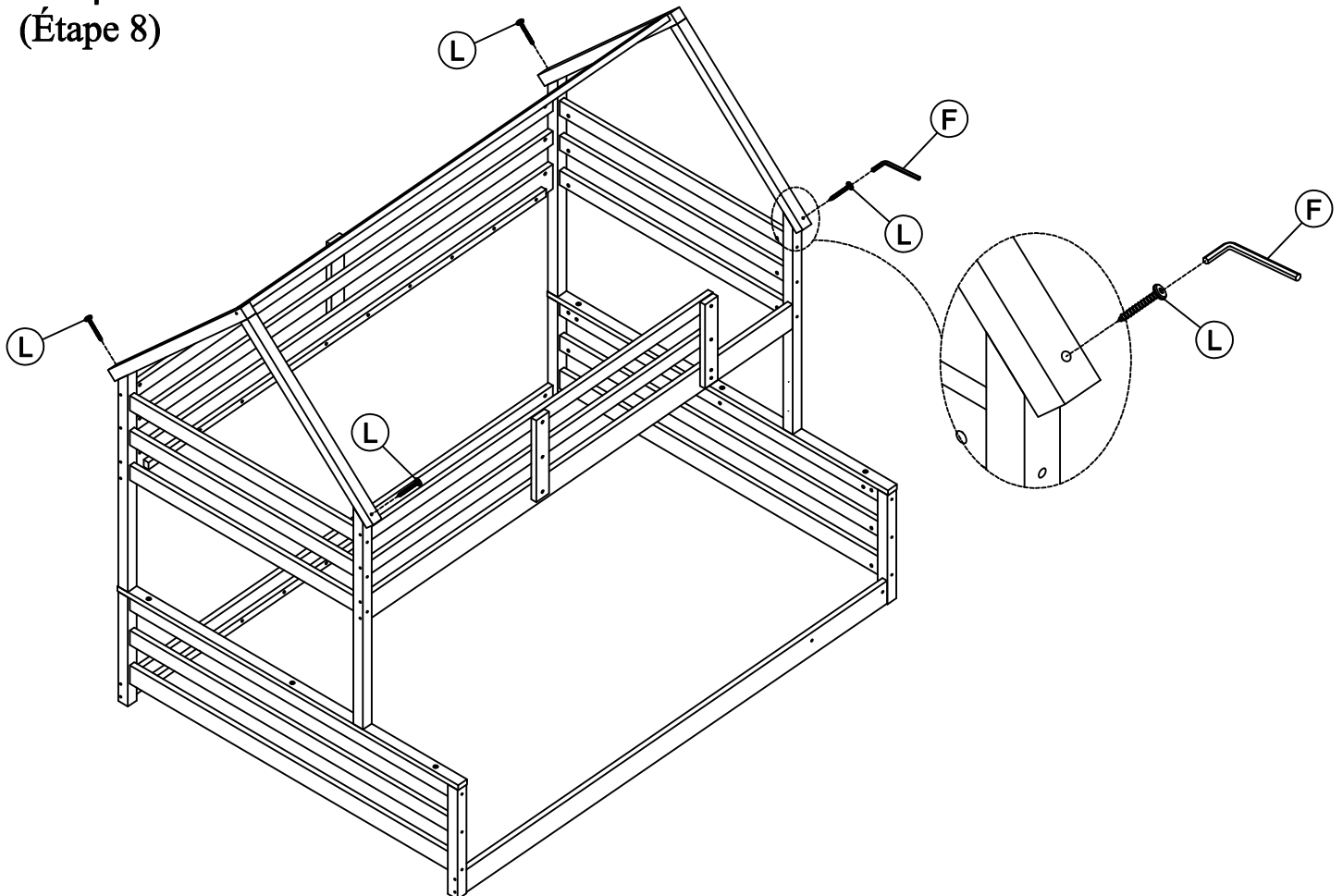

F	4x58		1PC				
D	1/4x90		2PCS	H	Ø10x40		2PCS

Step 8 (Étape 8)





L	6.5x60		4PCS	F	4x58		1PC
----------	--------	-------------------------------------------------------------------------------------	------	----------	------	---------------------------------------------------------------------------------------	-----

ASSEMBLY INSTRUCTIONS

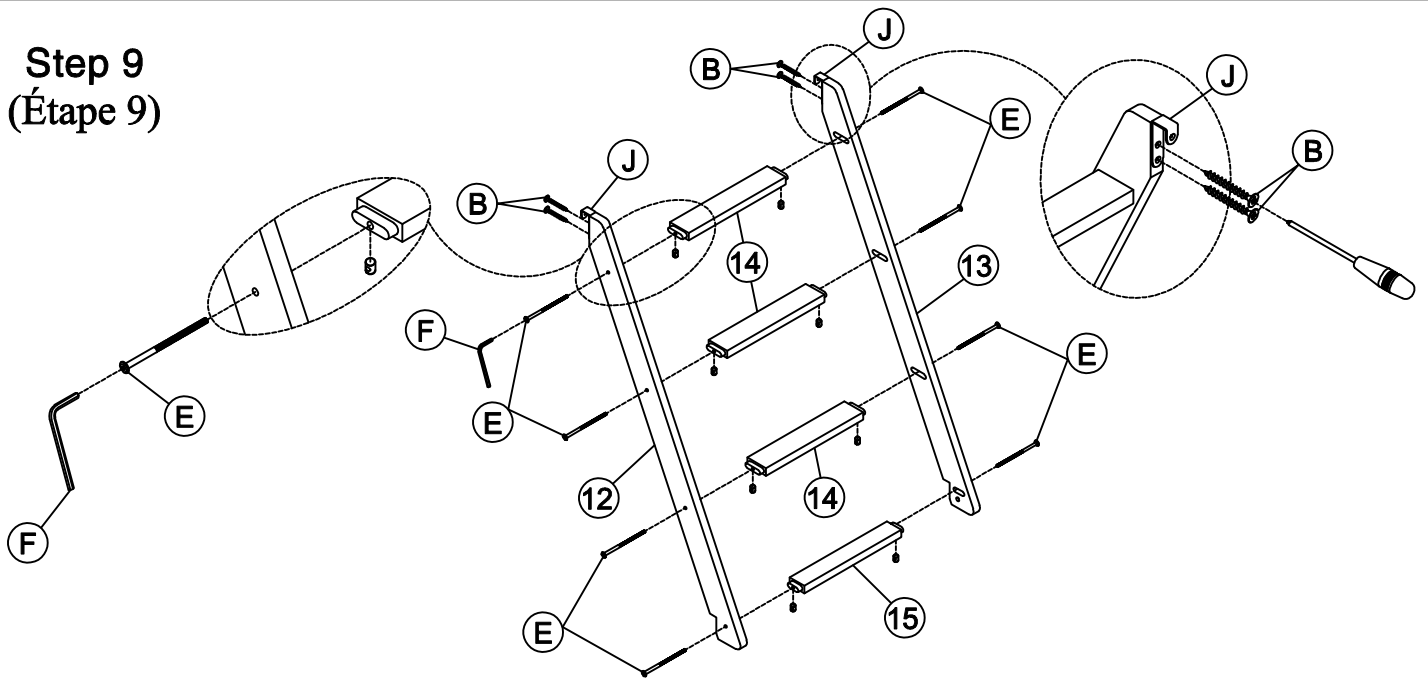

Step 9 (Étape 9)

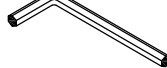

B	Ø4x15		4PCS	E	1/4x60		8PCS
J	70x18x2		2PCS	F	4x58		1PC

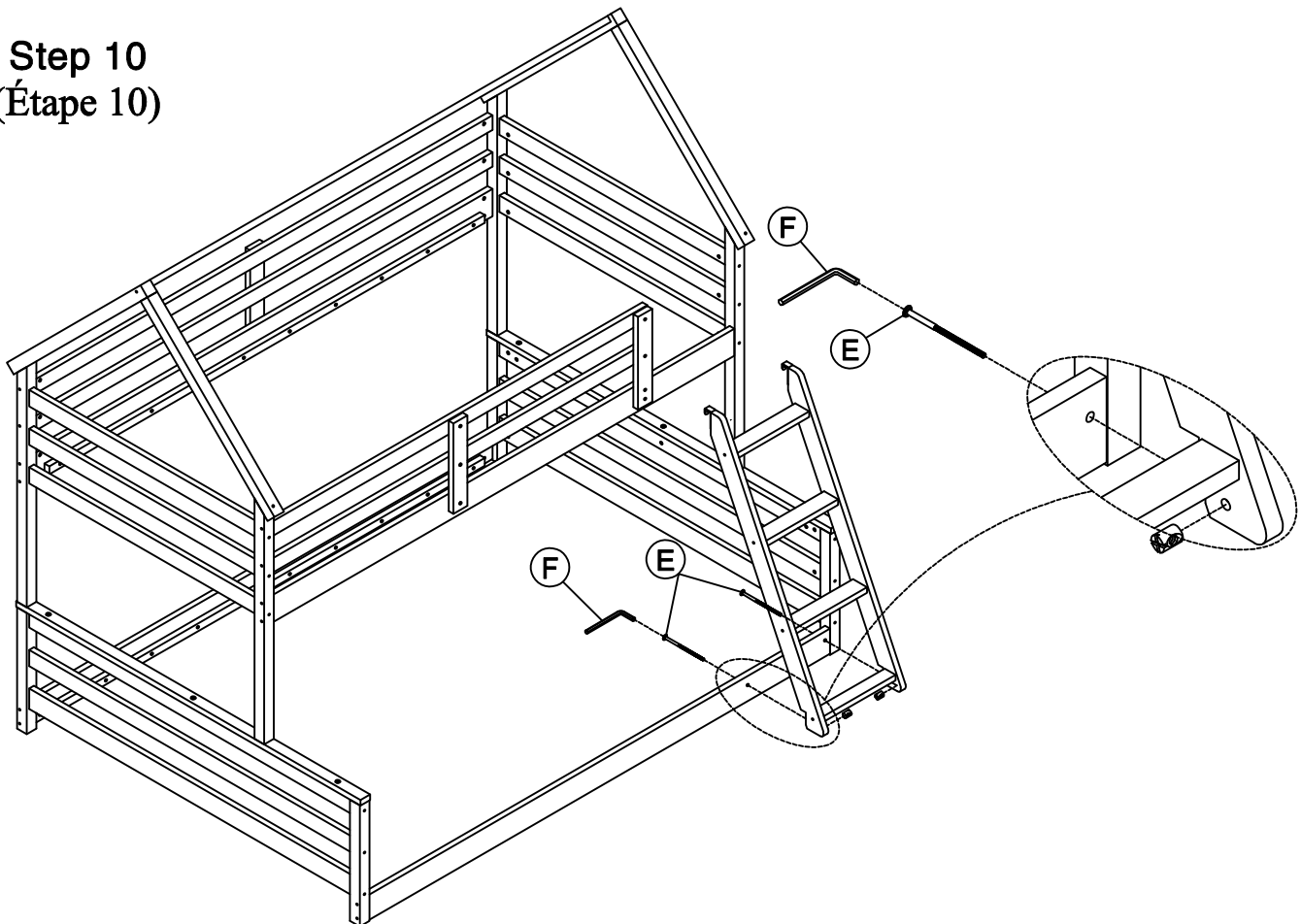
Step 10 (Étape 10)



F	4x58		1PC	E	1/4x60		2PCS
----------	------	-------------------------------------------------------------------------------------	-----	----------	--------	---------------------------------------------------------------------------------------	------

ASSEMBLY INSTRUCTIONS

Step 11 (Étape 11)

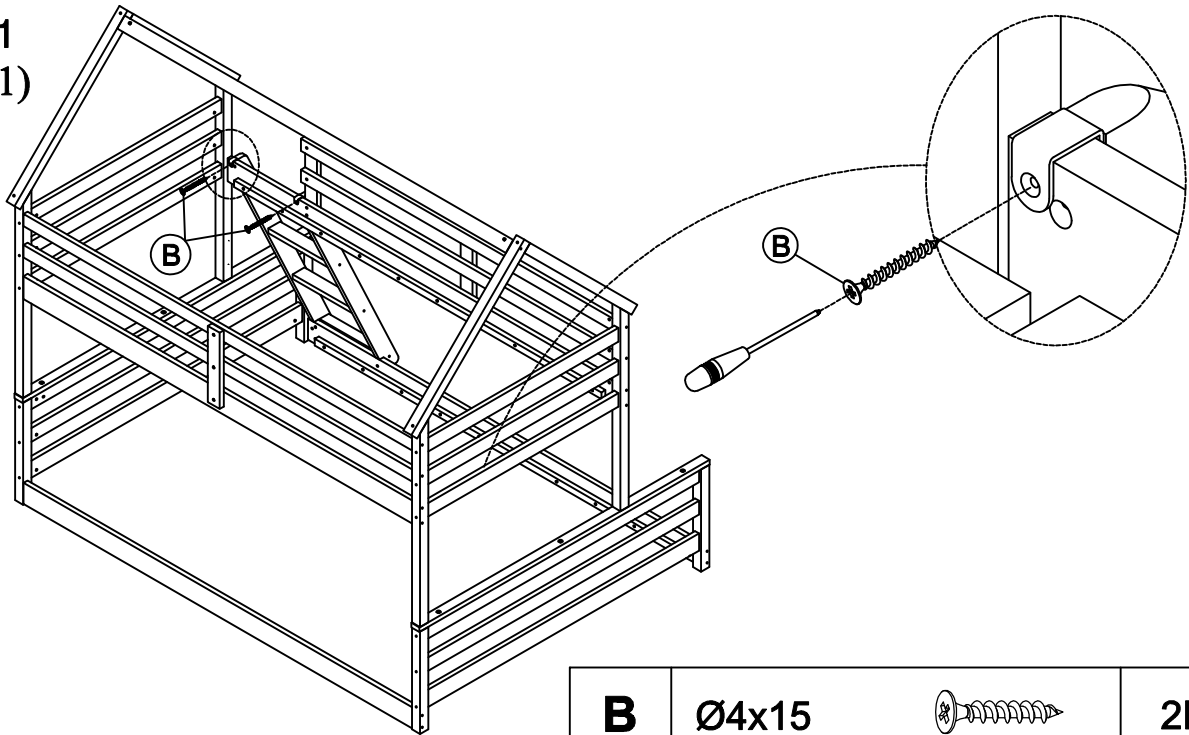

B

Ø4x15



2PCS

Step 12 (Étape 12)

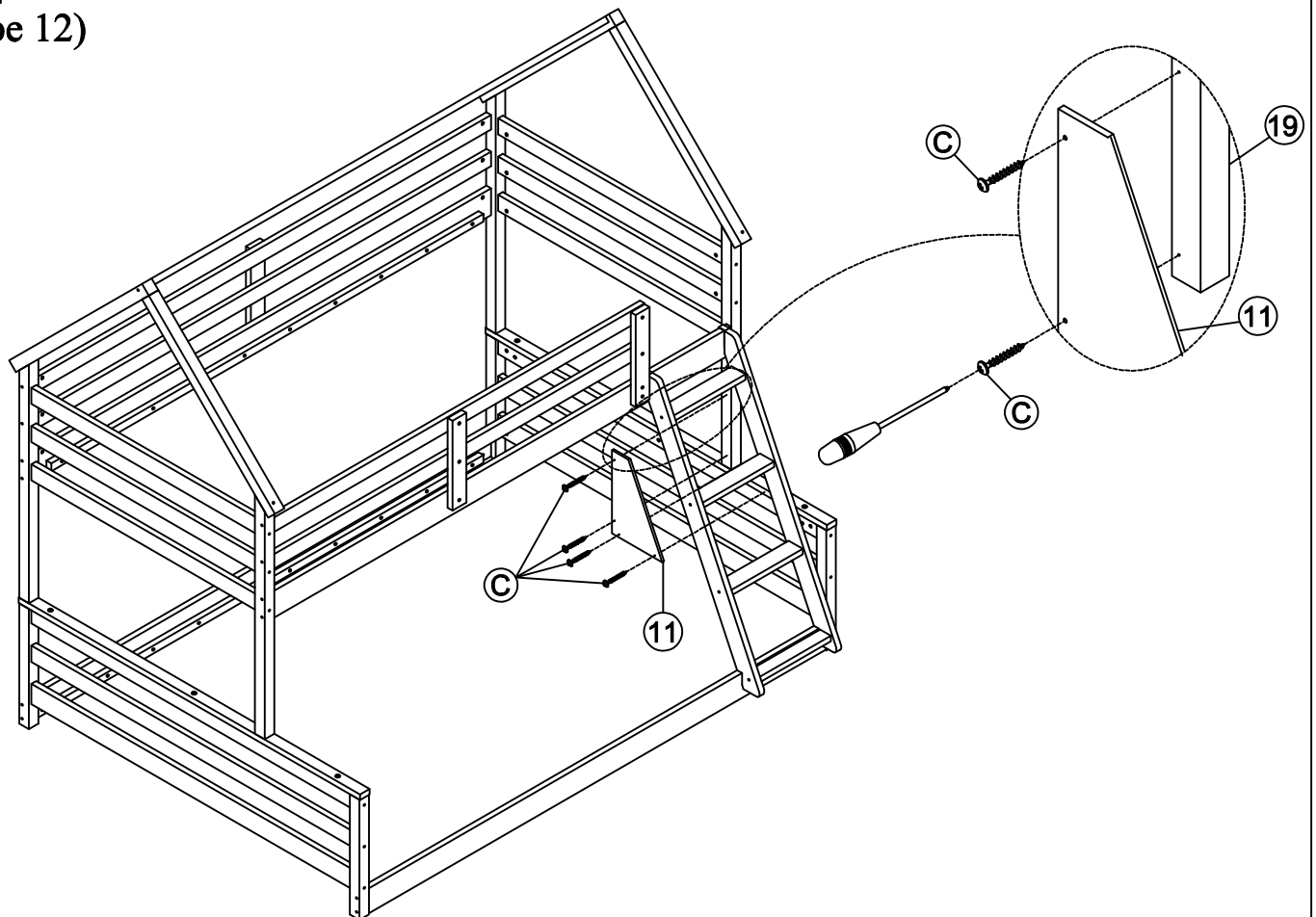

C

Ø4x20



4PCS

ASSEMBLY INSTRUCTIONS

Step 13 (Étape 13)

First attach 2 pcs part 21 to the front and end of the frame between headboard. Then attach the remaining part 21 equidistantly between headboard

Fixez d'abord les 2 pièces 21 à l'avant et à l'extrémité du cadre entre la tête de lit. Fixez ensuite le reste partie 21 à égale distance entre la tête de lit

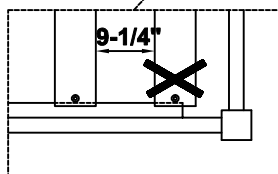
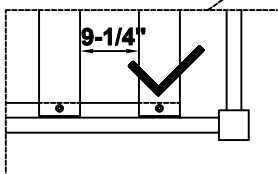
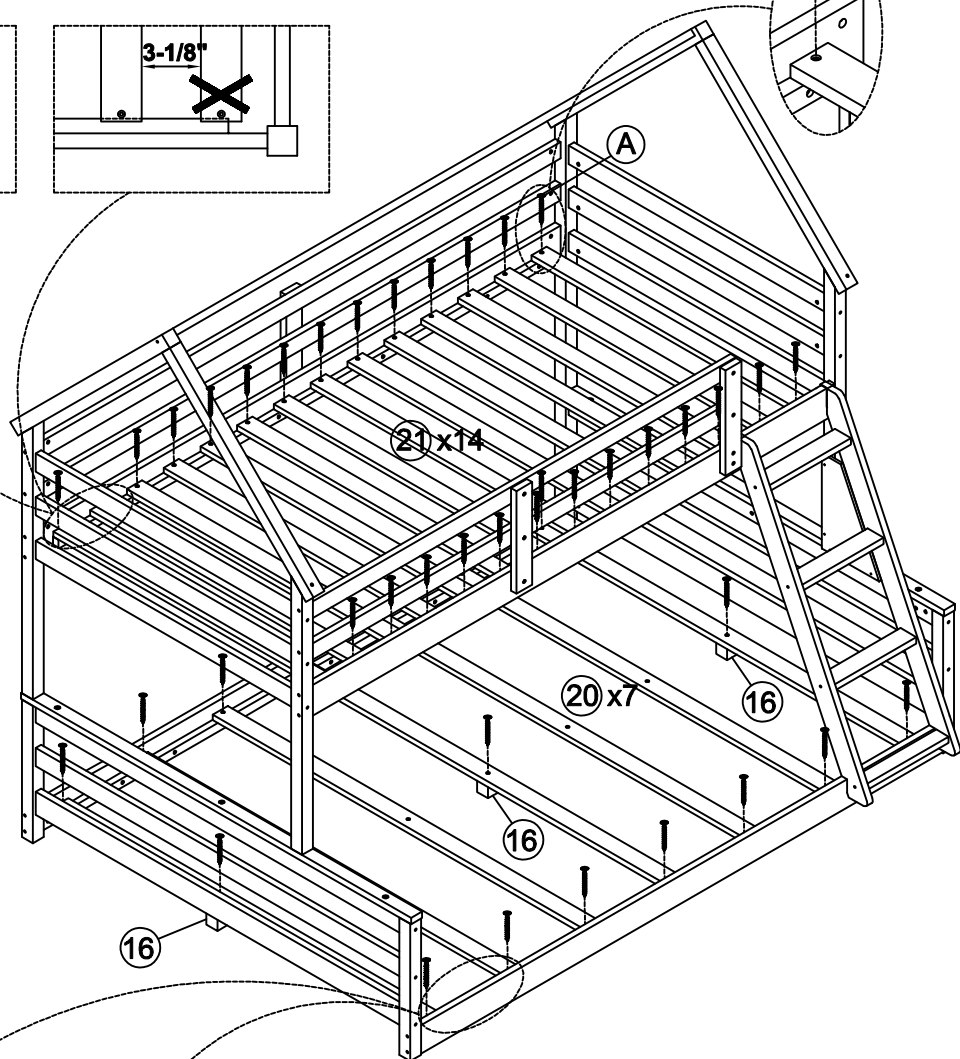
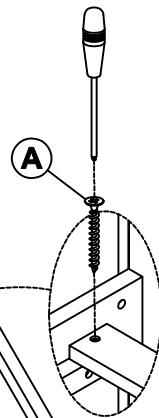
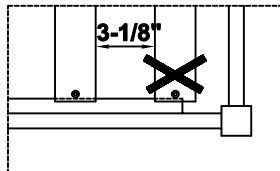
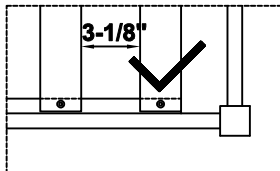

First attach 2 pcs part 20 to the front and end of the frame between headboard. Then attach the remaining part 20 equidistantly between headboard

Fixez d'abord les 2 pièces 20 à l'avant et à l'extrémité du cadre entre la tête de lit. Fixez ensuite le reste partie 20 à égale distance entre la tête de lit

A

Ø4x30



45PCS