

















ASSEMBLY INSTRUCTIONS

Don't tighten any Bolts until all Bolts on a step have been started

Thank you for purchasing this quality product. Be sure to check all packing material carefully for small parts, which may have come loose inside the carton during shipment. Identify and count all parts and compare with the **HARDWARE LIST** below.

NO.	PARTS LIST		Q' TY	NO.	PARTS LIST		Q' TY
A		Stool back	1	1		1/4"*3"	4
B		Seat Frame	1	2		1/4"*2"	4
C		Left leg	1	3		1/4"*1-1/2"	1
D		Right leg	1	4		#8*1-3/4"	6
E		Left stretcher	1	5		1/4"	9
F		Right stretcher	1	6		1/4"*19MM	9
G		Front stretcher	1	7		Allen wrench	1
H		Linen fabric seat	1	8		#8*3/4"	4

STEP 1

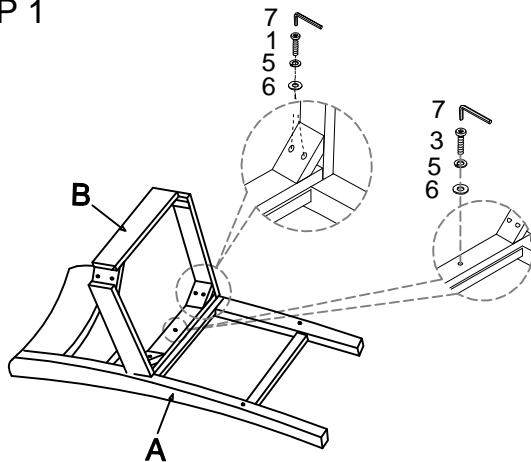

1. Loosely attach the Seat frame (B) to the Stool back (A), using Bolts (3+5+6) to tighten, as shown.
2. Using Bolts (1+5+6) to tighten, as shown.

STEP 2

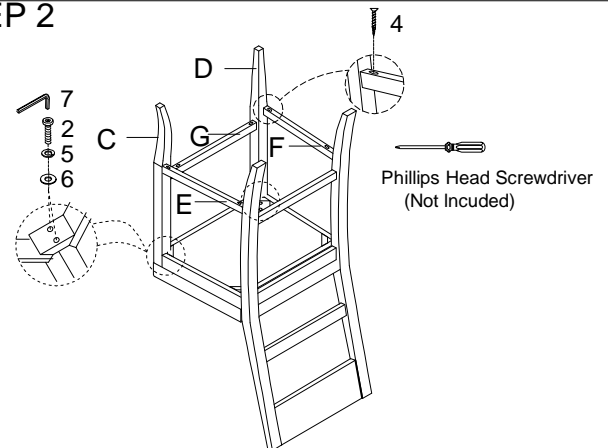

1. Loosely attach the left leg (C) and Right leg (D) to the Linen fabric seat (B), using Bolts (2+5+6) to tighten, as shown.
2. Attach the Front/Back stretcher (G) and Right/left stretcher (E/F) to the legs, using Screw (4) and a Phillips head screwdriver to tighten, as shown.

STEP 3

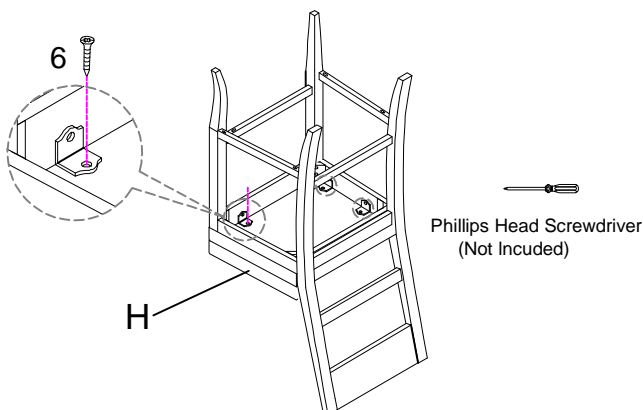

STEP 4

1. Right side up the stool.
2. It's complete for using.

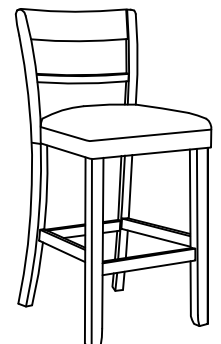

Caution: 1: All bolts must be tightened mandatorily in easy step.
2: It is also mandatorily recommended to periodically check bolts and retighten as needed.

If you find that your furniture has a missing or damaged part, contact our customer service representative at the number shown, and we will be happy to assist you.
Thank you for making American Woodcrafters a part of your home.